



POWER NETWORK METER

END25



USER'S MANUAL

Installation & Operating Instructions

Section	Contents
1.	Introduction
2.	Measurement and Energy/Counter Screens
	2.1 Current Reversal Screen
	2.2 Phase Rotation Error Screen
	2.3 Phase Absent Screen
	2.4 Real Time Clock
	2.5 Individual Harmonics
	2.6 Timer 1 & Timer 2 Screens
	2.7 Run Hour
	2.8 On Hour
	2.9 Number of Interruption
3.	Programming
	3.1 Password Protection
	3.2 Menu Selection
	3.2.1 System Parameter Selection
	3.2.1.1 System Type
	3.2.1.2 Potential Transformer Primary Value
	3.2.1.3 Potential Transformer Secondary Value
	3.2.1.4 Current Transformer Primary Value
	3.2.1.5 Current Transformer Secondary Value
	3.2.1.6 System Frequency
	3.2.1.7 Demand Integration Time
	3.2.1.8 Auto Scrolling
	3.2.1.9 Low Current Noise Cutoff
	3.2.1.10 No. of Poles
	3.2.1.11 Energy Output
	3.2.1.12 Energy Digit Reset Count
	3.2.1.13 Energy Rate
	3.2.1.14 Impulse Rate
	3.2.1.15 Quit System Parameters

- 3.2.2 Communication Parameter Selection
 - 3.2.2.1 Address Setting
 - 3.2.2.2 RS 485 Baud Rate
 - 3.2.2.3 RS 485 Parity
 - 3.2.2.4 Quit Communication Parameters
- 3.2.3 IP Parameter Selection
 - 3.2.3.1 IP Address Setting
 - 3.2.3.2 Subnet mask Setting
 - 3.2.3.3 Default gateway Setting
 - 3.2.3.4 Server Port Setting
 - 3.2.3.5 Quit IP Parameters
- 3.2.4 Reset Parameter Selection
 - 3.2.4.1 Resetting Parameter
- 3.2.5 Output Option Selection
 - 3.2.5.1 Relay Selection
 - 3.2.5.1.1 Relay 1 or 2 Output Selection Menu
 - 3.2.5.1.1.1 Pulse Output
 - 3.2.5.1.1.1.1 Parameter Selection
 - 3.2.5.1.1.1.2 Pulse Duration
 - 3.2.5.1.1.1.3 Pulse Rate
 - 3.2.5.1.1.1.4 Quit Pulse Output
 - 3.2.5.1.1.2 Limit Output
 - 3.2.5.1.1.2.1 Limit Output Parameters
 - 3.2.5.1.1.2.2 Energy Count Configuration
 - 3.2.5.1.1.2.3 Energy Trip Point
 - 3.2.5.1.1.2.4 Energy Count ON Delay
 - 3.2.5.1.1.2.5 Parameter Configuration
 - 3.2.5.1.1.2.6 Trip Point
 - 3.2.5.1.1.2.7 Hysteresis
 - 3.2.5.1.1.2.8 Energizing Delay
 - 3.2.5.1.1.2.9 De-energizing Delay
 - 3.2.5.1.1.2.10 Quit Limit Output
 - 3.2.5.1.1.3 Timer
 - 3.2.5.1.1.3.1 Number of Cycles
 - 3.2.5.1.1.3.2 Timer Configuration
 - 3.2.5.1.1.3.3 On Delay
 - 3.2.5.1.1.3.4 Off Delay

- 3.2.5.1.1.3.5 Quit Timer Output
- 3.2.5.1.1.4 RTC Relay
 - 3.2.5.1.1.4.1 Weekdays Selection
 - 3.2.5.1.1.4.2 Relay Configuration
 - 3.2.5.1.1.4.3 ON Time
 - 3.2.5.1.1.4.4 OFF Time
 - 3.2.5.1.1.4.5 Quit RTC Output

3.2.6 Datalog Option Selection

- 3.2.6.1 Event Based Datalog Setup
 - 3.2.6.1.1 Event Based Datalog Selection
 - 3.2.6.1.2 Quit Event Datalog
- 3.2.6.2 Time Based Datalog Setup
 - 3.2.6.2.1 Time Based Datalog Selection
 - 3.2.6.2.2 Time Interval Selection
 - 3.2.6.2.3 Parameter Count
 - 3.2.6.2.4 Parameter Selection
 - 3.2.6.2.5 Quit Time Based Datalog
- 3.2.6.3 Load Profile Datalog Setup
 - 3.2.6.3.1 Load Profile Datalog Selection
 - 3.2.6.3.2 Quit Load Profile Datalog selection
- 3.2.6.4 Quit Datalog Option

3.2.7 Display Parameters

- 3.2.7.1 Feature Selection Menu
 - 3.2.7.1.1 Backlit
 - 3.2.7.1.2 User Assignable Screens
 - 3.2.7.1.2.1 Screen Number Selection
 - 3.2.7.1.2.2 User Screens Selection
 - 3.2.7.1.2.3 Quit Userscreens
 - 3.2.7.1.3 Contrast
 - 3.2.7.1.4 Quit Display Parameters

3.2.8 RTC Setting Screen

- 3.2.8.1 Date Settings
- 3.2.8.2 Time Settings
- 3.2.8.3 Quit RTC

3.2.9 Factory Reset Screen

3.2.10 Quit

- 4. Energy Auto-Ranging On Display
 - 4.1 Calculating Display energy (Auto-ranging)

- 4.2 Entering Energy start count
- 5. Relay Output
 - 5.1 Pulse Output
 - 5.2 Limit Switch
 - 5.3 Timer Output
- 6. Phasor Diagram
- 7. Installation
 - 7.1 EMC Installation Requirements
 - 7.2 Case Dimensions and Panel Cut-out
 - 7.3 Wiring
 - 7.4 Auxiliary Supply
 - 7.5 Fusing
 - 7.6 Earth / Ground Connections
- 8. Connection Diagrams
- 9. Optional Pluggable Module
- 10. Specification
- 11. Connection for Optional Pulse Output / RS 485

1. INTRODUCTION

The Multifunction Instrument is a panel mounted 96 x 96mm DIN Quadratic Digital Panel Meter, which measures important electrical parameters in 3 ph 4 wire / 3 wire / 1ph Network and replaces the multiple analog panel meters. It measures electrical parameters like AC voltage, Current, Frequency, Power, Energy (Active / Reactive / Apparent), phase angle, power factor, individual harmonics & many more. The instrument integrates accurate measurement technology (All Voltages & current measurements are True RMS upto 31st Harmonic) with LCD display with backlight.

It can be configured & Programmed at site for the following : PT Primary, PT Secondary, CT Primary, CT Secondary 3 Phase 3W, 3 Phase 4W, 1 Phase 2W system.

The front panel has three push buttons using which the user can scroll through different screens & configure the product. The front panel also has Impulse red led, flashing at rate proportional to measured power.

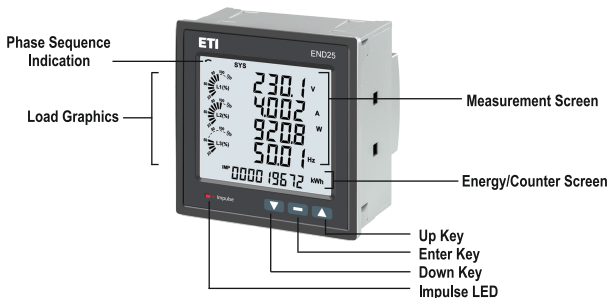

2. MEASUREMENT AND ENERGY/COUNTER SCREENS

In normal operation, the user is presented with two simultaneous screens:

1. One of the **Measurement screens** out of the screens 1 to 36 of Table 1.

These screens may be scrolled through one at a time in incremental order by pressing the "Up key" and in decremental order by pressing "Down key". Few important screens are explained in Section 2.1 to 2.6.

2. One of the **Energy/Counter screens** out of the screens 37 to 62 of Table 1.

These screens may be scrolled through one at a time in incremental order only by pressing the "Enter key" to roll over again in the same order. Few important screens are explained in Section 2.7 to 2.9.

Load Graphics

Load Graphics indicates the input current as the percentage of the CT Primary value. This indication is available for all measurement screens. For example, consider CT Primary to be set at 5A, then the input current of 2.5 A indicates 50% as shown below.

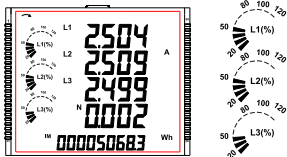

The absence of lines indicating the percentage implies that the input current is less than 20% of the CT Primary value.

Phase Sequence Indication

It indicates the rotation of input phasor vectors :
clockwise/ counter-clockwise.

In case the input is absent or the phase sequence is neither L123 nor L321, the phase sequence indication is not shown.



Clockwise Sequence
for L123.



Counter-Clockwise Sequence,
for L321

TABLE 1 : Measurement & Energy/Counter Screens for Advanced version of END25

Screen No.	Parameters	On Display			On Modbus		
		3P 4W	3P 3W	1P 2W	3P 4W	3P 3W	1P 2W
1	System Voltage/ Current/ Power/ Frequency	✓	✓	✓	✓	✓	✓
2	L-N Voltage	✓	✗	✗	✓	✗	✗
3	L-L Voltage	✓	✓	✗	✓	✓	✗
4	Current ,Neutral Current	✓	✓*	✗	✓	✓*	✗
5	Phase Voltage THD	✓	✓	✗	✓	✓	✗
6	Phase Current THD	✓	✓	✗	✓	✓	✗
7	L1 phase VA/VAr/W/PF	✓	✗	✗	✓	✗	✗
8	L2 phase VA/VAr/W/PF	✓	✗	✗	✓	✗	✗
9	L3 phase VA/VAr/W/PF	✓	✗	✗	✓	✗	✗
10	Phase Angle	✓	✗	✗	✓	✗	✗
11	VA/A demand	✓	✓	✓	✓	✓	✓
12	Capacitive, Inductive VAr demand	✓	✓	✓	✓	✓	✓
13	W IMP demand	✓	✓	✓	✓	✓	✓
14	W EXP demand	✓	✓	✓	✓	✓	✓
15	Max VA/A demand	✓	✓	✓	✓	✓	✓
16	Max Capacitive, Inductive VAr demand	✓	✓	✓	✓	✓	✓
17	Max W IMP demand	✓	✓	✓	✓	✓	✓
18	Max W EXP demand	✓	✓	✓	✓	✓	✓
19	Old Max VA/A demand	✗	✗	✗	✓	✓	✓
20	Old Max Capacitive, Inductive VAr demand	✗	✗	✗	✓	✓	✓
21	Old Max W IMP demand	✗	✗	✗	✓	✓	✓
22	Old Max W EXP demand	✗	✗	✗	✓	✓	✓
23	Sys RPM/Frequency	✓	✓	✓	✓	✓	✓
24	Sys Active/Reactive/Apparent power	✓	✓	✓	✓	✓	✓
25	Sys Apparent, Reactive (Power), Phase angle, PF	✓	✓	✓	✓	✓	✓
26	Min Sys Voltage / Current	✓	✓	✓	✓	✓	✓
27	Max Sys Voltage / Current	✓	✓	✓	✓	✓	✓
28	Sys %THD Voltage /Current	✓	✓	✓	✓	✓	✓
29	Current Reversal	✓	✗	✓	✗	✗	✗
30	Phase rotation error	✓	✓	✗	✗	✗	✗
31	Phase absent indication	✓	✗	✗	✗	✗	✗
32	RTC	✓	✓	✓	✓	✓	✓

*Note: In 3P3W system, Neutral Current is not shown, only line currents are shown.

TABLE 1 : Continued...

Screen No.	Parameters	On Display			On Modbus		
		3P 4W	3P 3W	1P 2W	3P 4W	3P 3W	1P 2W
33	Individual harmonics V	✓	✓	✓	✓	✓	✓
34	Individual harmonics A	✓	✓	✓	✓	✓	✓
35	Timer1 No. of Cycles, ON, OFF delay	✓	✓	✓	✓	✓	✓
36	Timer2 No. of Cycles, ON, OFF delay	✓	✓	✓	✓	✓	✓
37	Active Energy Import(Overflow)	✗	✗	✗	✓	✓	✓
38	Active Energy Import	✓	✓	✓	✓	✓	✓
39	Active Energy Export(Overflow)	✗	✗	✗	✓	✓	✓
40	Active Energy Export	✓	✓	✓	✓	✓	✓
41	Reactive Capacitive energy (Overflow)	✗	✗	✗	✓	✓	✓
42	Reactive Capacitive energy	✓	✓	✓	✓	✓	✓
43	Reactive Inductive energy (Overflow)	✗	✗	✗	✓	✓	✓
44	Reactive Inductive energy	✓	✓	✓	✓	✓	✓
45	Apparent energy(Overflow)	✗	✗	✗	✓	✓	✓
46	Apparent energy	✓	✓	✓	✓	✓	✓
47	Run hour	✓	✓	✓	✓	✓	✓
48	On hour	✓	✓	✓	✓	✓	✓
49	No. of interrupts	✓	✓	✓	✓	✓	✓
50	Old Active energy Import(Overflow)	✗	✗	✗	✓	✓	✓
51	Old Active energy Import	✗	✗	✗	✓	✓	✓
52	Old Active energy Export(Overflow)	✗	✗	✗	✓	✓	✓
53	Old Active energy Export	✗	✗	✗	✓	✓	✓
54	Old Reactive Capacitive energy (Overflow)	✗	✗	✗	✓	✓	✓
55	Old Reactive Capacitive energy	✗	✗	✗	✓	✓	✓
56	Old Reactive Inductive energy (Overflow)	✗	✗	✗	✓	✓	✓
57	Old Reactive Inductive energy	✗	✗	✗	✓	✓	✓
58	Old Apparent energy(Overflow)	✗	✗	✗	✓	✓	✓
59	Old Apparent energy	✗	✗	✗	✓	✓	✓
60	Old Run hour	✗	✗	✗	✓	✓	✓
61	Old On hour	✗	✗	✗	✓	✓	✓
62	Old no. of interrupts	✗	✗	✗	✓	✓	✓

Note: (1) Only screens (with screen number) 1 to 32 are available for selectable Userscreens.

(2) Energy on Display is Auto-Ranging For details refer Section 4.1.

2.1 Current Reversal Screen

This screen is useful to indicate if current in any phase is reversed or not. If current in any phase gets reversed, then corresponding phase will be indicated on this screen.

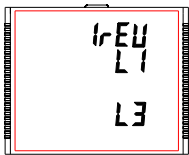

This screen shows that currents in L1 and L3 are reversed.

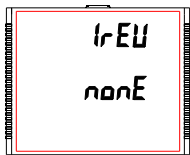

This screen shows that currents in all three phase are correct.

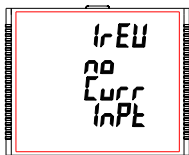

This screen shows that the meter has no current input.

2.2 Phase Rotation Error Screen

Meter shows phase rotation information for the phase sequence R-Y-B (L1-L2-L3).

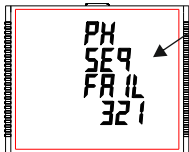

This screen indicates that Phase Sequence is incorrect.

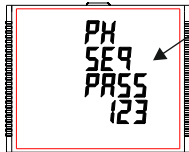

This screen indicates that Phase Sequence is correct.

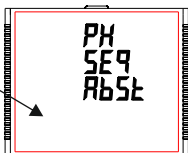

This screen indicates that all three phases (voltages) are absent.

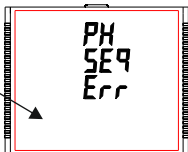

This screen indicates that either one or two of the three phases (voltages) are absent.

User must check this screen in order to get correct readings when meter is connected.

2.3 Phase Absent Screen

This screen is useful to indicate if voltage or current in any phase is absent. Hence, user will know which voltage or current is missing and take corrective action.

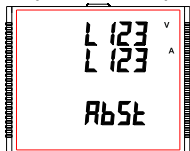

This screen indicates that all three phases (volt. & current) are absent.

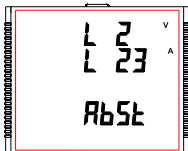

This screen indicates that V2, I2 and I3 are absent.

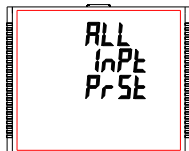

This screen indicates that all three phases are present i.e. all inputs are present.

2.4 Real Time Clock

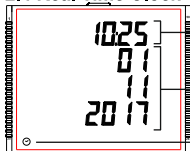

Time of the day (HH:MM in 24 hour format)

Date of the day (DD/MM/YYYY)

Symbol Indicating RTC Screen

2.5 Individual Harmonics



The **Individual Harmonics** can be accessed by pressing the Enter key followed by the Up and Down keys taking through the 31 harmonics.



Similarly, pressing the " = " key at the **quit screen** takes the user out of the Individual Harmonics Screen.

2.6 Timer 1 & Timer 2 Screens

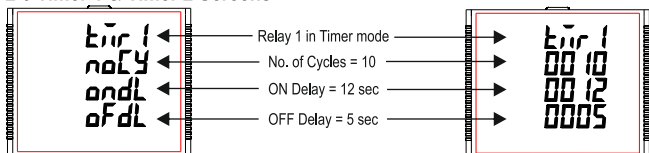

The screen shows the No. of Cycles, on delay, off delay of the corresponding relay in its timer mode. If the relay is configured in timer mode, then the timer can be turned ON by long press (about 3sec) of Up key while present in any of the measurement screens.

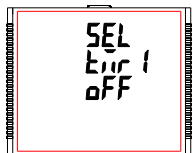

Relay 1 is not selected in Timer Configuration.

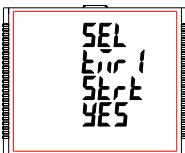

This screen is shown when relay is configured as timer. by selecting yes option timer1 can be started.

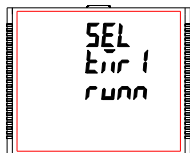

Timer showing Running when it is started.

Similarly, the Relay can be turned OFF by long press (about 3sec) of Down key while present in any of the measurement screens.

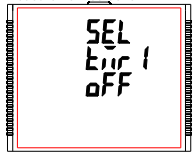

Relay 1 is not selected in Timer Configuration.

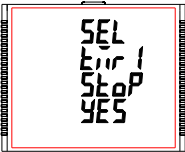

This screen is shown when timer is started .by selecting yes option timer1 can be stopped.

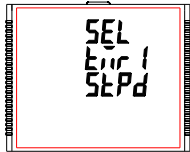

Timer showing Stopped when not running.

Similarly, for Timer Configuration, Relay 2 parameters and status can also be set and accessed (respectively) in a way similar to that of Relay 1.

2.7 Run Hour

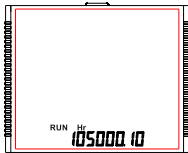

This Screen shows the total no. of hours the load is connected. Even if the Auxiliary supply is interrupted, count of Run hour will be maintained in internal memory & displayed in the format "hours. min".

For example if Displayed count is 105000.10 it indicates 105000 hours & 10 minutes. After 999999.59 run hours display will restart from zero. To reset run hour manually see section Resetting Parameter 3.2.3.1.

2.8 On Hour

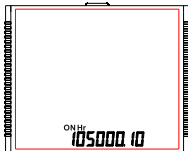

This Screen shows the total no. of hours the Auxiliary Supply is ON. Even if the Auxiliary supply is interrupted count of On hour will be maintained in internal memory & displayed in the format "hours. min".

For example if Displayed count is 105000.10 it indicates 105000 hours and 10 minutes. After 999999.59 On hours display will restart from zero. To reset On hour manually see section Resetting Parameter 3.2.3.1.

2.9 Number of Interruption

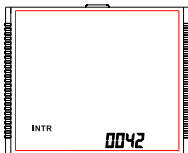

This Screen Displays the total no. of times the Auxiliary Supply was Interrupted. Even if the Auxiliary supply is interrupted count will be maintained in internal memory. To reset No of Interruption manually see section Resetting Parameter 3.2.3.1.

Setup Parameter Screens

CodE (PassWord)

SEL (Select)

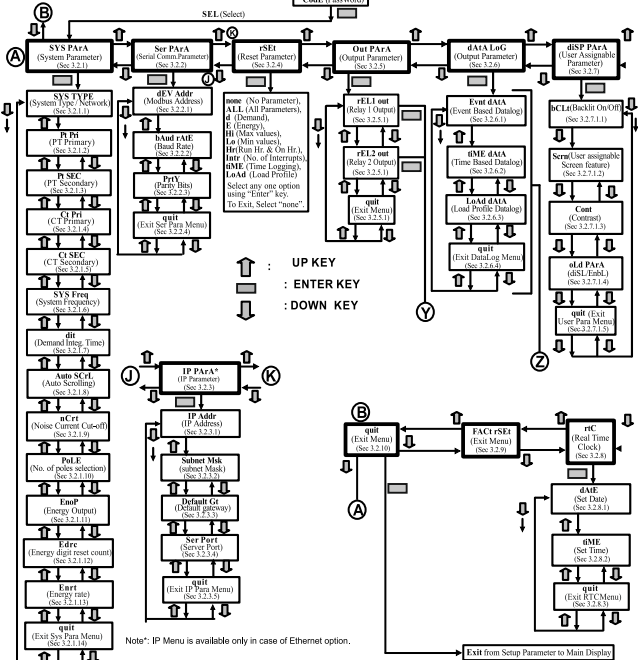

Note*: IP Menu is available only in case of Ethernet option.

Output Options Parameters

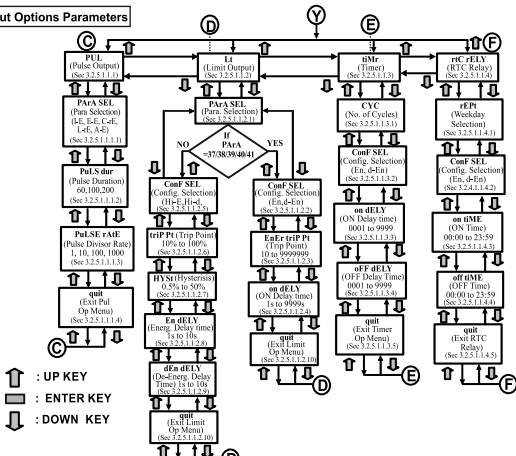

Datalog Options Parameters

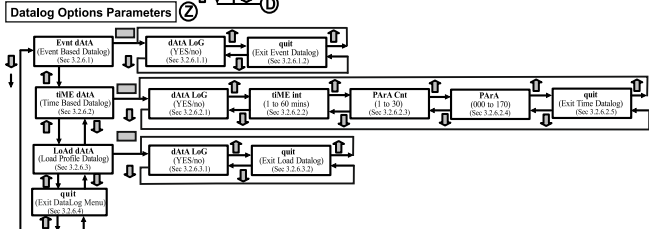

3. PROGRAMMING

The following sections comprise step by step procedures for configuring the Multifunction Meter according to individual user requirements. To access the set-up screens press and hold "▲ UP" and "▼ DOWN" keys simultaneously for 5 seconds. This will take the User into the Password Protection Entry Stage (Section 3.1).

3.1. Password Protection

Password protection can be enabled to prevent unauthorised access to set-up screens, when default password protection is not enabled. Password protection is enabled by selecting a four digit number other than 0000, setting a password of 0000 disables the password protection.

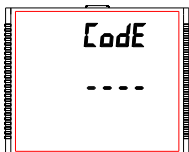

Enter Password, prompt for first digit. Press the "▲" key to scroll the value of first digit from 0 through to 9, the value rolls back from 9 round to 0 and "▼" key to scroll the value of first digit from 9 through to 0, the value rolls back from 0 round to 9.

Press the "■" key to advance to next digit.

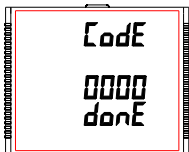

In special case where the Password is "0000" pressing the "■" key when prompted for the first digit advances to the password accepted screen and then pressing the "■" key again makes the set-up screens accessible to the user.

But instead of pressing the "■" key, if "▲" or "▼" key is pressed, the user is taken to the "New/change Password" entry stage.

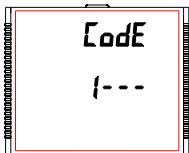

Enter Password, first digit entered, prompt for second digit..

Press the "▲" key to scroll the value of first digit from 0 through to 9, the value rolls back from 9 round to 0 and "▼" key to scroll the value of first digit from 9 through to 0, the value rolls back from 0 round to 9.

Press the "■" key to advance to next digit.

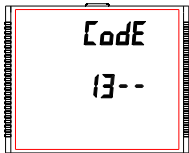

Enter Password, second digit entered, prompt for third digit.

Press the "▲" key to scroll the value of first digit from 0 through to 9, the value rolls back from 9 round to 0 and "▼" key to scroll the value of first digit from 9 through to 0, the value rolls back from 0 round to 9.

Press the "▬" key to advance to next digit.

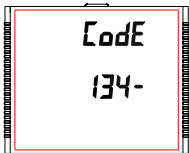

Enter Password, third digit entered, prompt for fourth digit .

Press the "▲" key to scroll the value of first digit from 0 through to 9, the value rolls back from 9 round to 0 and "▼" key to scroll the value of first digit from 9 through to 0, the value rolls back from 0 round to 9.

Press the "▬" key to advance to verification of the password.

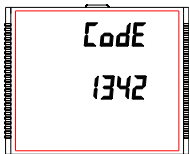

Enter Password, fourth digit entered, awaiting verification of the password.

Password confirmed.

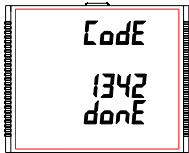

Pressing "▲" or "▼" key advances to the "New / change Password" entry stage.

Pressing the "▬" key advances to the Menu selection (setup menu) screen (see Section 3.2).

Password Incorrect.

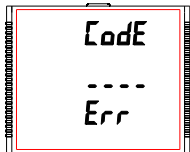

The unit has not accepted the Password entered.

Pressing the "▲" or "▼" key advances to the Enter Password stage.

Pressing the "■" key exits the Password menu & returns operation to the measurement reading mode.

New / Change Password

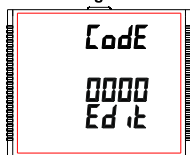

Prompting for first digit.

Press the "▲" and "▼" keys to scroll the value of first digit from 0 through to 9 and from 9 through to 0, respectively with digit roll around feature.

Pressing the "■" key advances the operation to the next digit and sets the first digit, in this case to "2".

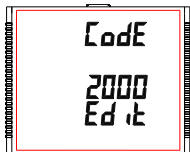

New/ Change Password, first digit entered, prompting for second digit.

Press the "▲" and "▼" keys to scroll the value of second digit from 0 through to 9 and from 9 through to 0, respectively with digit roll around feature.

Pressing the "■" key advances the operation to the next digit and sets the second digit, in this case to "1".

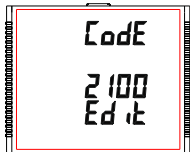

New/ Change Password, second digit entered, prompting for third digit.

Press the "▲" and "▼" keys to scroll the value of second digit from 0 through to 9 and from 9 through to 0, respectively with digit roll around feature.

Pressing the "■" key to advance the operation to the next digit and sets the third digit, in this case to "5".

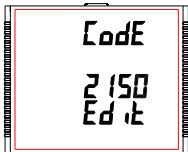

New/ Change Password, third digit entered, prompting for fourth digit. .

Press the "▲" and "▼" keys to scroll the value of second digit from 0 through to 9 and from 9 through to 0, respectively with digit roll around feature.

Pressing the "■" key to advance the "New Password Confirmed" and sets the fourth digit, in this case to "3".

New Password confirmed

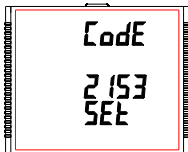

Pressing the "▲" or "▼" key returns to the "New/Change Password" stage.

Pressing the "■" key advances to the Menu selection screen (see Section 3.2).

3.2 Menu selection.

3.2.1 System Parameter Selection



This screen is used to select different system Parameters like "system type", "CT Ratio", "PT Ratio", etc. Pressing the "■" key allows the user to set Different system parameters (see Section 3.2.1.1 to 3.2.1.12).

Pressing the "▲" key advances to the "Communication Parameter Selection" screen (see section 3.2.2) and pressing "▼" key advances to the "Quit Setup" Screen (see section 3.2.9).

3.2.2 Communication Parameter Selection



This screen is used to select the different communication parameters like "Address selection", "RS485 Parity selection", "RS485 baud rate", etc. Pressing the "←" key allows the user to set different Communication parameters (see Section 3.2.2.1 to 3.2.2.3). Pressing the "▲" key advances to the "Reset Parameter Selection" screen (if ethernet module is present then it will advance to IP parameter selection see section 3.2.3) (see section 3.2.4) and pressing "▼" key advances to the "System Parameter Selection" screen (see Section 3.2.1).

3.2.3 IP Parameter Selection



This screen is used to select the different communication parameters like "IP Address selection", "Subnet mask selection", "default gateway selection", "server port selection etc. Pressing the "←" key allows the user to set different Ethernet parameters (see Section 3,2,3,1 to 3,2,3,5).

Pressing the "▲" key advances to the "Reset Parameter Selection" screen (see section 3,2,4) and pressing "▼" key advances to the "Communication Parameter Selection" screen (see Section 3,2,2).

3.2.4 Reset Parameter Selection



This screen is used to reset different parameters.

Pressing the "←" key allows the user to reset different system parameters (see Section 3.2.4.1).

Pressing the "▲" key advances to the "Output Option Selection" screen (see Section 3.2.5) and pressing "▼" key advances to "Communication Parameter Selection" screen (ethernet module is present then it advances to IP parameter selection else it goes to serial communication parameter selection) (see Section 3.2.2).

3.2.5 Output Option Selection



This screen will allow the user to select Output Options like "Relay Output".

Pressing the " " key allows the user to select and configure the output options (see Section 3.2.5.1).

Pressing the "▲" key advances to the "Datalog Option Selection" screen (see section 3.2.6) and pressing "▼" key advances to "Reset Parameter Selection" screen (see Section 3.2.4).

3.2.6 Datalog Option Selection



This screen will allow the user to select Datalog Options like "Event Based", "Time Based" and "Load Profile".

Pressing the " " key allows the user to select and configure the datalog options (see section 3.2.6.1).

Pressing the "▲" key advances to "Display Parameters" screen (see section 3.2.7) and pressing "▼" key advances to "Output Option Selection" screen (see Section 3.2.5).

3.2.7 Display Parameters



This screen will allow the user to access different features like "Backlit", "Screens", "Contrast" and "Old Parameters".

Pressing the " " key allows the user to select and configure the features (see Section 3.2.7.1).

Pressing the "▲" key advances to "RTC Setting" screen (see Section 3.2.8) and pressing "▼" key advances to "Datalog Option Selection" screen (see Section 3.2.6).

3.2.8 RTC Setting

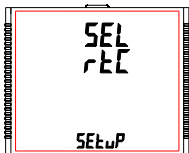

This screen will allow the user to access features like “Set Date” and “Set Time”.

Pressing the “←” key allows the user to select date and time (see Section 3.2.8.1).

Pressing the “▲” key advances to “Factory Reset” screen (see Section 3.2.9) and pressing “▼” key advances to “Display Parameters” screen (see Section 3.2.7).

3.2.9 Factory Reset



This screen allows the user to set the meter to its Factory Default settings (see Section 3.2.9.1).

Pressing the “▲” key advances to “Quit Setup” screen (see Section 3.2.10) and pressing “▼” key advances to “RTC Setting” screen (see Section 3.2.9).

3.2.10 Quit Setup



This screen will allow the user to quit the setup menu (see Section 3.2.10.1)

Pressing the “←” key allows the user to Quit from setup menu & return to measurement screen.

Pressing the “▲” key advances to “System Parameter Selection” screen (see Section 3.2.1) and pressing “▼” key advances to “Factory Reset” screen (see Section 3.2.9).

3.2.1 System Parameter Selection

3.2.1.1 System Type

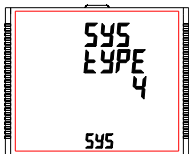

This screen is used to set the system type.

Pressing the " = " key advances into the system type edit mode and pressing the "▲" and "▼" key scrolls through the options available:

System type "3" for 3 phase 3 wire, "4" for 3 phase 4 wire system & "1" for single phase system.

Pressing the " = " key advances to "PJs Wait" screen, accepting the present value and returns to the "System Type" menu (see Section 3.2.1.1).

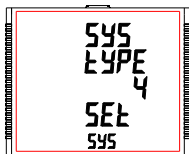

Once the System type is set and "System Type" menu appears (see Section 3.2.1.1), pressing "▲" key advances to the "Potential Transformer Primary Value" screen (see Section 3.2.1.2) and pressing the "▼" key advances to "Quit System Parameters" screen (see Section 3.2.1.14). **Default value is set to '4' i.e. 3P 4W.**

⚠ Caution: If System type is changed then log of data will reset.

3.2.1.2 Potential Transformer Primary Value

The nominal full scale voltage is displayed as the **Line to Line** voltages for all system types. The values displayed represent the voltage in **kilovolts** (note "k" symbol).

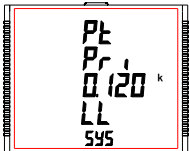

Pressing the "▲" key accepts the present value and advances to the "Potential Transformer Secondary Value" screen (see Section 3.2.1.3).

Similarly, pressing the "▼" key accepts the present value and advances to the "System Type" screen (see Section 3.2.1.1).

Pressing the " = " key advances to the "Potential Transformer Primary Decimal Point Edit" mode.

Potential Transformer Primary Decimal Point Edit

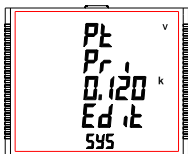

(Flashing decimal point indicates the cursor position). Initially the "decimal point must be selected, pressing the "▲" or "▼" key moves the decimal point position to the right until it disappears, which means that it has reached ###.#. after which it returns to #.###.

Note: The absence of decimal point in edit mode implies ###.#. decimal point position.

Pressing the "■" key accepts the present decimal point position and advances to the "Potential Transformer Primary Digit Edit" mode.

Potential Transformer Primary Digit Edit

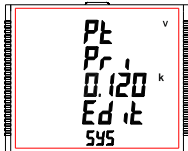

Pressing the "▲" or "▼" key scrolls the value of the most significant digit from 0 through 9 or 9 through 0, respectively unless the present displayed Potential Transformer Primary Value together with the Current Potential Transformer Primary Value, previously set, results in a maximum system power of greater than 5400 MVA (1800 MVA per phase) in which case the digit range gets restricted.

Pressing the "■" key accepts the present value at the cursor position and advances the cursor to the next less significant digit.

The PT Primary value can be set from 100 VL-L to 1200 kVL-L. The value will be forced to 100 VL-L if set less than 100.

Note: The flashing digit indicates the cursor position, a steady decimal point is present to identify the scaling of the number until the cursor position coincides with the steady decimal point position. At this stage the digit will flash.

When the least significant digit has been set, pressing the "■" key shows "Pls Wait" screen which is followed by the "Potential Transformer Primary Value" screen (see Section 3.2.1.2).

Note : PT Values must be set as Line to Line Voltage for Primary as Well as Secondary for all system types (3P3W/3P4W/1P2W).

The default value is '0.415 kVLL'.

3.2.1.3 Potential Transformer Secondary Value

The value must be set to the nominal full scale secondary voltage which will be obtained from the Transformer when the potential transformer (PT) primary is supplied with the voltage defined in 3.2.1.2 Potential Transformer Primary voltage. The ratio of full scale primary to full scale secondary is defined as the transformer ratio. The PT Secondary value can be set from 100VL-L to 600VL-L (according to input voltage range).

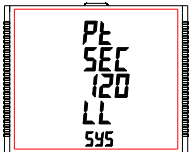

Pressing the "▲" key accepts the present value and advances to the "Current Transformer Primary Value" screen (see Section 3.2.1.4).

Similarly, pressing the "▼" key accepts the present value and advances to the "Potential Transformer Primary Value" screen (see Section 3.2.1.2). Pressing the "■" key advances to the "Potential Transformer Secondary Digit Edit" mode.

Potential Transformer Secondary Digit Edit

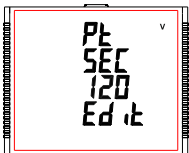

Pressing the "▲" or "▼" key scrolls the value of the most significant digit from 0 through 9 or 9 through 0, respectively.

Pressing the "■" key accepts the present value at the cursor position and advances the cursor to the next less significant digit.

After entering the least significant digit, pressing the "■" key sets the value and advances to the "Pls Wait" screen followed by the "Potential Transformer Secondary Value" screen (see Section 3.2.1.3). The default value is 415 VLL.

3.2.1.4 Current Transformer Primary Value

The nominal Full Scale Current that will be displayed as the Line currents. This screen enables the user to display the Line currents inclusive of any transformer ratios, the values displayed represent the Current in Amps.

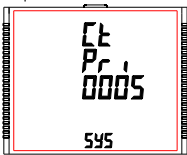

Pressing the "▲" key accepts the present value and advances to the "Current Transformer Secondary Value" screen (see Section 3.2.1.5).

Similarly, pressing the "▼" key accepts the present value and advances to the "Potential Transformer Secondary Value" menu (see Section 3.2.1.3).

Pressing the "■" key advances to the "Current Transformer Primary Digit Edit" mode.

Current Transformer Primary Digit Edit

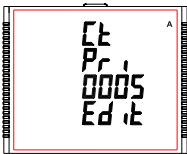

Pressing the "▲" or "▼" key scrolls the value of the most significant digit from 0 through 9 or 9 through 0, respectively (with digit roll over feature) unless the present displayed Current Transformer Primary Value together with the Potential Transformer Primary Value results in a maximum system power of greater than 5400 MVA (1800 MVA per phase) in which case the digit range gets restricted, the value will wrap.

Example: If primary value of PT is set as 1200 kVL-L (max value) then primary value of Current is restricted to 1804 A.

Pressing the "■" key accepts the present value at the cursor position and advances the cursor to the next less significant digit.

The "Maximum Power" restriction of 5400 MVA refers to 200% of nominal current and 120% of nominal voltage, i.e. 2250 MVA nominal power .

After entering the least significant digit, pressing the "■" key sets the value and advances to the "Pls Wait" screen followed by "Current Transformer Primary Value" screen (see Section 3.2.1.4).

NOTE: Default value is set to '5' i.e. 5A.

3.2.1.5 Current Transformer Secondary Value

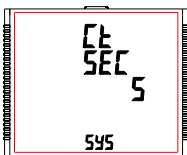

This screen is used to set the secondary value for Current Transformer. Secondary value "5" for **5A** or "1" for **1A** can be selected.

Pressing the "▲" key accepts the present value and advances to the "System Frequency" menu (see Section 3.2.1.6).

Similarly, pressing the "▼" key accepts the present value and advances to the "Current Transformer Primary Value" screen (see Section 3.2.1.4).

Pressing the "■" key advances to the "CT Secondary Value Edit" mode and keys "▲" and "▼" scroll the value through the options available.

Pressing the "■" key sets the option selected and advances to "Pls Wait" screen followed by "Current Transformer Secondary Value" screen (see Section 3.2.1.5).

NOTE: Default value is set to '5' i.e.

3.2.1.6 System Frequency

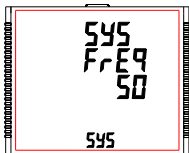

This screen is used to set the frequency of the input. The Unit of displayed values is Hz.

Pressing the "■" key enables editing and pressing the "▲" or "▼" key scrolls through the following Options: **50,60** Hz.

Once the desired option has been selected, pressing "■" key confirms the selection and advances to the "System Frequency" menu (see Section 3.2.1.6).

Pressing the "▲" key advances to "Demand Integration Time" screen (see Section 3.2.1.7) and pressing the "▼" key advances to "Current Transformer Secondary Value" screen (see Section 3.2.1.5).

Note: (1) The applied frequency and the entered frequency value should be same.

(2) Default value is set to '50' Hz.

3.2.1.7 Demand Integration Time

This screen is used to set the period over which current and power readings are to be integrated. The Unit of displayed values is **minutes**.

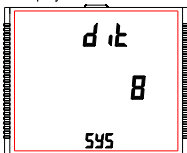

Pressing the "■" key enables editing and pressing keys "▲" and "▼" allows scrolling through the following Options: **8,15,20,30**.

Once the desired option is selected, pressing "■" key confirms the selection and advances to "Pls Wait" screen followed by "Demand Integration Time" screen (see Section 3.2.1.7).

Pressing the "▲" key advances to "Auto Scrolling" screen (see Section 3.2.1.8) and pressing the "▼" key advances to "System Frequency" screen (see Section 3.2.1.6).

NOTE: Default value is set to '8' i.e. 8 min.

3.2.1.8 Auto Scrolling

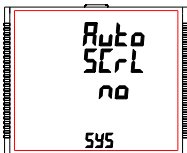

This screen allows user to enable screen scrolling.

Pressing "▲" key accepts the present status and advance to the "Low Current Noise Cutoff" screen (see Section 3.2.1.9). Similarly, pressing "▼" key accepts the present status and advances to the "Demand Integration Time" screen (see Section 3.2.1.7).

Pressing the "■" key allows editing and keys "▲" and "▼" allows the user to select either 'Yes' to enable autoscroll and 'No' to disable autoscroll.

Pressing "■" key selects the status displayed and advances to "Auto Scrolling" screen (see Section 3.2.1.8).

NOTE: (1) Default value is set to 'NO'.

(2) With Autoscrolling mode ON, Individual harmonics screens are not displayed.

3.2.1.9 Low Current Noise Cutoff

This screen allows the user to set Low noise current cutoff in **mA**.

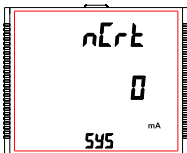

Pressing "▲" key accepts the present value and advance to "No. of Poles" screen (see Section 3.2.1.10). Similarly, pressing "▼" key accepts the present value and advance to "Auto Scrolling" screen (see Section 3.2.1.8).

Pressing the "■" key allows editing and the user can select either 0 mA or 30 mA using "▲" and "▼" keys.

Pressing the “**■**” key confirms the selection and advances to “Low Current Noise Cutoff” screen (see Section 3.2.1.9).

NOTE: Default value is set as ‘0’ mA.

3.2.1.10 No. of Poles

This screen enables to set No. of poles of a Generator of which RPM is to be measured and to which the instrument is connected to monitor its parameters.

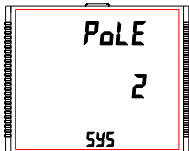

Pressing “**▲**” key accepts the present selection and advances to “Energy Output” menu (see Section 3.2.1.11). Similarly, pressing “**▼**” key accepts the present selection and advances to “Low Current Noise Cutoff” screen (See section 3.2.1.9).

Pressing the “**■**” key advances to editing mode for no. of poles and pressing “**▲**” and “**▼**” keys scrolls the number from 2 to 40 and 40 to 2, respectively in steps of 2.

Pressing the “**■**” key selects the status displayed and enter the “No. of Poles” menu (see Section 3.2.1.10).

NOTE: Default value is set to ‘2’.

3.2.1.11. Energy Output

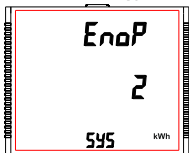

This screen enables user to set energy on modbus in terms of Wh / kWh / MWh as per the requirement . Same is applicable to all types of energy.

Pressing “**▲**” key accepts the presents value and advances to the “Energy Digit Reset Count” screen (see Section 3.2.1.12).

Similarly, pressing “**▼**” key accepts the present value and advances to the “No. of Poles” menu (see Section 3.2.1.10).

Pressing the “**■**” key will enter the editing mode for energy output and “**▲**” and “**▼**” keys scrolls through the values 1,2 & 3 and in the reverse order, respectively, with roll over feature:

1 : Energy In Wh

2 : Energy in kWh

3 : Energy in MWh

Pressing the “**■**” key sets the value selected and advances to “Pls Wait” screen followed by “Energy Output” menu (see Section 3.2.1.11).

NOTE: 1. Default value is set to '2' i.e. Energy will be in terms of kWh/kVAh/kVAh respectively.

2. If (PT primary(VLL) * CT primary * Root3) >30000 kW, then Energy Output can be set only as kWh and MWh.

3. Energy on display is auto-ranging & so this setting is only applicable for modbus energy counters.
(For Energy auto-ranging refer section on 4.1.)

3.2.1.12 Energy Digit Reset Count

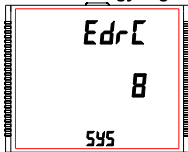

This screen enables user for setting maximum energy count after which energy on modbus will roll over to zero. User can select one of: **7,8,9**.

Pressing the "▲" key accepts the present value and will advance to the "Energy Rate" screen (see Section 3.2.1.13). Similarly, pressing the "▼" key accepts the present value and will advance to the "Energy Output" menu (see Section 3.2.1.11).

Pressing the "■" key advances to the Energy Digit Reset Count edit mode. Pressing the "▲" and "▼" key will scroll the value of reset count from 7 to 9 and 9 to 7, respectively with rollover feature.

Ex. If Energy Digit count is set to 9 then energy on modbus will reset after "999,999,999" & rollback to zero and simultaneously the corresponding Overflow count value increases by 1.

Pressing "■" key sets the value selected and advances to "Pls Wait" screen followed by "Energy Digit Reset Count" screen (see Section 3.2.1.12).

Note:(1) Default value is set to '8' i.e. if energy count crosses 8 digits, then it will reset to zero.

(2) Energy on Display is Auto-Ranging for details (see section 4.1)

3.2.1.13 Energy Rate

This screen allows user to enter energy update rate in minutes. After entering particular value in minutes, the energy will be updated on modbus location from 30145 to 30165 of 3X register and 40145 to 40165 of 4X register as per value that user has entered.

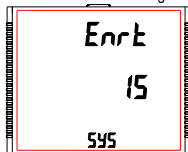

The user can select any integral value between **1 and 60** minutes.

Pressing the "▲" key accepts the present value and advances to "Impulse rate" screen (see Section 3.2.1.14).

Similarly, pressing the "▼" key accepts the present value and advances to "Energy Digit Reset Count" screen (see Section 3.2.1.12).

Pressing the “**—**” key advances to the Energy Rate edit mode. Pressing “**▲**” and “**▼**” scrolls the count in minutes from 1 to 60 and from 60 to 1, respectively. **Ex.** If Energy Rate is set to 2 then energy will get stored after 2 minutes on the modbus.

Pressing “**—**” key sets the value selected and advances to the “Energy Rate” menu (see Section 3.2.1.13).

NOTE: Default value is set to ‘15’ i.e. 15 min.

3.2.1.14 Impulse Rate



This screen shows user to Impulse rate depending upon the PT secondary and CT Secondary set by user.

'k' indicates value is multiplied by 1000.

Pressing the “**▲**” key advances to “quit” screen (see Section 3.2.1.1). Similarly, pressing the “**▼**” key advances to “Energy Rate” screen (see Section 3.2.1.13).

System nominal power	Impulse constant
<=400	16000
<=800	8000
<=1600	4000
<=3200	2000
>3200	1000

3.2.1.15 Quit System Parameters

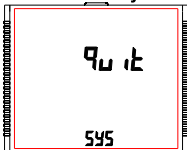

This screen allows user to Exit from System Parameter selection setup.

Pressing the "▲" key advances to "System Type" screen (see Section 3.2.1.1). Similarly, pressing the "▼" key advances to "Impulse Rate" screen (see Section 3.2.1.14). Pressing the "■" key advances to "System Parameter Selection" screen (see Section 3.2.1).

3.2.2 Communication Parameter Selection

3.2.2.1 Address Setting



This screen applies to the RS 485 output only. This screen allows the user to set RS 485 address for the meter.

The allowable range of addresses is 1 to 247.

Press "▲" key to advance to "RS 485 Baud Rate" screen (see Section 3.2.2.2) or press the "▼" key to advance to the "Quit Communication Parameters" screen (see Section 3.2.2.4).



Press "■" to enter into edit mode, prompt for first digit.

Press the "▲" and "▼" keys to scroll the value of the first digit. Press the "■" key to advance to next digit.

Similarly, enter second and third digits of address. After entering third digit, pressing "■" key confirms the selection and shows "Address Setting" screen (see Section 3.2.2.1).

The default setting is '1'.

3.2.2.2 RS 485 Baud Rate

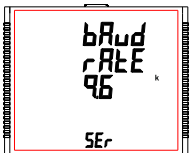

This screen allows the user to set Baud Rate of RS 485 port. The values displayed on screen are in kbaud.

Pressing "▲" key accepts the present value and advance to the "RS 485 Parity Selection" screen (see Section 3.2.2.3) and pressing the "▼" key accepts the present value and advance to the "Address Setting" screen (see Section 3.2.2.1).

Pressing the "■" key advances to the "Baud Rate Edit" mode and "▲" & "▼" keys scrolls the value through **4.8, 9.6, 19.2, 38.4 and 57.6** kbaud.

Pressing the "■" key sets the value and shows the "RS 485 Baud Rate" screen (see Section 3.2.2.2).

3.2.2.3 RS 485 Parity

This screen allows the user to set Parity & number of stop bits of RS 485 port.

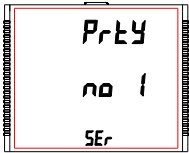

Pressing "▲" key accepts the present value and advances to "Quit Communication Parameters" screen (see section 3.2.2.4). Similarly, pressing "▼" key accepts the present value and advances to "RS 485 Baud Rate" screen (see section 3.2.2.2).

Pressing the "■" key advances to the "Parity & Stop bit Edit" mode & keys "▲" and "▼" scrolls the value through:
no 1 : no parity with one stop bit no 2 : no parity with two stop bit
E : even parity with one stop bit odd : odd parity with one stop bit

Pressing "■" key sets the value and advances to "RS 485 Parity Selection" screen (see Section 3.2.2.3).

NOTE: Default value is set as 'no 1'.

3.2.2.4 Quit Communication Parameters

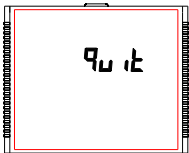

This screen allows user to exit from system "Communication Parameter Selection" setup.

Pressing the "▲" key advances to "Communication Parameter Selection" screen (see Section 3.2.2.1). Similarly, pressing the "▼" key advances to "RS 485 Parity" screen (see Section 3.2.2.3).

Pressing the "■" key advances to "Communication Parameter Selection" screen (see Section 3.2.2).

3.2.3 IP Parameter Selection

3.2.3.1 IP Address Setting

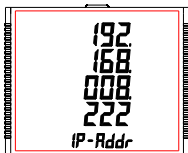

This screen allows the user to set IP address.

Pressing "▲" key accepts the present value and advance to the "Quit Ip parameters" screen (see Section 3.2.3.5) and pressing the "▼" key accepts the present value and advance to the "Subnet Mask Setting" screen (see Section 3.2.3.2).

Pressing the "■" key advances to the "IP address Edit" mode

Pressing the "■" key sets the value and shows the "IP address Edit Screen" (see Section 3.2.3.1).

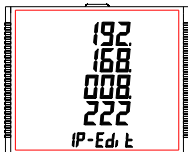

Pressing the "▲" or "▼" key scrolls the value of the most significant digit from 0 through 9 or 9 through 0, respectively

Pressing the "■" key accepts the present value at the cursor position and advances the cursor to the next less significant digit.

user can set value from 000.000.000.000 to 255.255.255.255.

After entering the least significant digit, pressing the "■" key sets the value

3.2.3.2 Subnet Mask Setting



This screen allows the user to set Subnet Mask.

Pressing "▲" key accepts the present value and advance to the "IP address setting" screen (see Section 3.2.3.1) and pressing the "▼" key accepts the present value and advance to the "Default gateway Setting" screen (see Section 3.2.3.3).

Pressing the "■" key advances to the "Subnet Mask Edit" mode

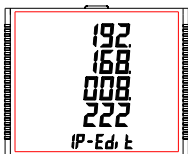

Pressing the "▲" or "▼" key scrolls the value of the most significant digit from 0 through 9 or 9 through 0, respectively
Pressing the "■" key accepts the present value at the cursor position and advances the cursor to the next less significant digit.
user can set value from 000.000.000.000 to 255.255.255.255.
After entering the least significant digit, pressing the "■" key sets the value

3.2.3.3 Default Gateway Setting

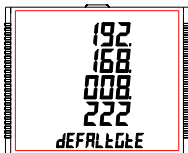

This screen allows the user to set Subnet Mask.
Pressing "▲" key accepts the present value and advance to the "Subnet Mask setting" screen (see Section 3.2.3.2) and pressing the "▼" key accepts the present value and advance to the "Server port Setting" screen (see Section 3.2.3.4).

Pressing the "■" key advances to the "Default Gateway Edit" mode

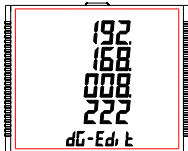

Pressing the "▲" or "▼" key scrolls the value of the most significant digit from 0 through 9 or 9 through 0, respectively
Pressing the "■" key accepts the present value at the cursor position and advances the cursor to the next less significant digit.
user can set value from 000.000.000.000 to 255.255.255.255.
After entering the least significant digit, pressing the "■" key sets the value

3.2.3.4 Server Port Settings



This screen allows the user to set Server Port for the meter. The allowable range of addresses is 001 to 999.

Press "▲" key to advance to "Default Gateway" screen (see Section 3.2.3.3) or press the "▼" key to advance to the "Quit IP Parameters" screen (see Section 3.2.3.5).

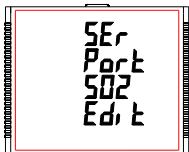

Press "■" to enter into edit mode, prompt for first digit.

Press the "▲" and "▼" keys to scroll the value of the first digit. Press the "■" key to advance to next digit.

Similarly, enter second and third digits of address. After entering third digit, pressing "■" key confirms the selection and shows "Server Port Setting" screen (see Section 3.2.3.4).

The default setting is '502'.

3.2.3.5 Quit IP Parameters

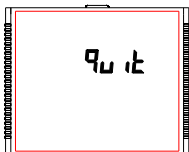

This screen allows user to exit from system "IP Communication Parameter Selection" setup.

Pressing the "▼" key advances to "Server Port Selection" screen (see Section 3.2.3.4). Similarly, pressing the "▲" key advances to "IP address Selection" screen (see Section 3.2.3.1).

Pressing the "■" key advances to "IP Parameter Selection" screen (see Section 3.2.3).

3.2.4 Reset Parameter Selection

3.2.4.1 Resetting Parameter

This screen allows the users to reset Energy, Lo(Min), hi(Max), Demand, Run hour, On hour, No. of Interrupts, Load Profile and Time Datalog.

Reset Parameters



Reset (None)

Pressing " " key advances to "Reset Parameters" screen. Pressing the "▲" or "▼" key advances to "Reset Parameter Selection" screen (see section 3.2.4).

Pressing the " " key advances to edit mode.

Edit mode

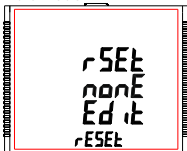

Pressing "▲" & "▼" keys scroll through the parameters given below:

ALL : reset all resettable parameters

d : reset all demand parameters

E : reset all energies

Hi : reset maximum values of voltage & current

Lo : reset minimum values of voltage & current

hr : reset run hour & on hour

intr : reset no. of auxiliary supply interruption count

time : reset the time based datalog buffers to store no values

LoAd : reset the load profile datalog buffers to store no values

Pressing the " " key advances to "Pls Wait" screen and resets the parameter selected followed by "Reset Parameters" screen.

Pressing the " " key advances to "Reset option" mode and pressing "▲" and "▼" keys advances to "Reset Parameter Selection" screen (see Section 3.2.4).

⚠ Caution : When Demand or Energy parameter are reset ,it will reset load profile log data.

3.2.5. Output Option Selection

This screen applies to the relay output option selection. Pressing " " key advances to "Relay Selection" menu (see Section 3.2.5.1).

3.2.5.1 Relay Selection

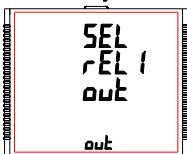

Pressing "▲" and "▼" keys scrolls through the following screens:

rEL1 : To select options for relay 1 (See section 3.2.5.1.1).

rEL2 : To select options for relay 2 (See section 3.2.5.1.1).

quit : To exit the Output Options menu and give the "Output Option Selection" screen (see Section 3.2.5).

Pressing " " key advances to Relay1 or 2 Output Selection menu (see Section 3.2.5.1.1).

3.2.5.1.1 Relay 1 or 2 Output Selection Menu

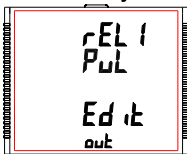

Pressing " " key makes the following options available for relay1 and relay2:

1. Pulse : Relay in Pulse output mode (see Section 3.2.5.1.1.1)

2. Limit : Relay in Limit output mode (see Section 3.2.5.1.1.2)

3. Timer : Relay in Timer output mode (see Section 3.2.5.1.1.3)

4. RTC Relay : Relay in RTC output mode (see Section 3.2.5.1.1.4)

Press "▲" and "▼" keys to navigate between the above options and press " " key to confirm the selection.

The default option is set as 'Pulse'.

3.2.5.1.1.1 Pulse Output

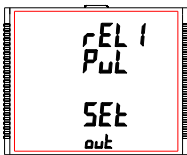

This screen is used to set the pulse output parameter.

Pressing "▲" key advances to "Parameter Selection" screen (see Section 3.2.5.1.1.1.1) whereas pressing "▼" key advances to "Quit Pulse Output" menu (see Section 3.2.5.1.1.1.4).

3.2.5.1.1.2 Limit Output

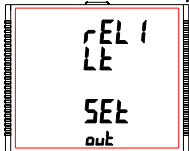

This screen is used to assign Relay in Limit output mode.

Pressing "▲" key shows "Parameter Selection" screen (see Section 3.2.5.1.1.2.1) whereas pressing "▼" key shows the "Quit Limit Output" screen (see Section 3.2.5.1.1.2.7).

3.2.5.1.1.3 Timer

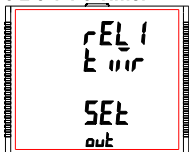

This screen is used to assign Relay in Timer output mode.

Pressing "▲" key will give the Number of Cycles menu (see Section 3.2.5.1.1.3.1) whereas pressing "▼" key gives the Quit Timer output menu (see Section 3.2.5.1.1.3.6).

3.2.5.1.1.4 RTC Relay

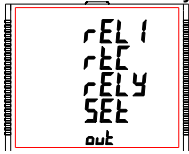

This screen is used to assign Relay in RTC output mode.

Pressing "▲" key advances to "Weekdays Selection" menu (see Section 3.2.5.1.1.4.1) whereas pressing "▼" key advances to "Quit RTC Output" menu (see Section 3.2.5.1.1.4.5).

3.2.5.1.1.1 Parameter Selection



This screen allows the user to assign energy for **pulse output**. Pressing "▲" key accepts the present setting and advance to "Pulse duration selection" (see section 3.2.5.1.1.1.2) and pressing "▼" key accepts the present setting and advance to "Quit Relay Output" selection (see section 3.2.5.1.1.1.4).

Pressing the "■" key advances to edit mode and "▲" and "▼" keys scrolls through the energy setting:

Edit mode



I - E : Import Energy (Active)
E - E : Export Energy (Active)
C - rE : Capacitive Reactive Energy
L - rE : Inductive Reactive Energy
A - E : Apparent Energy

Pressing the "■" key sets the value & gives the "Parameter Selection" menu (see section 3.2.5.1.1.1.1).

NOTE: Default configuration is set as 'I-E'.

3.2.5.1.1.1.2 Pulse Duration

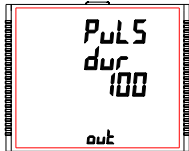

This screen applies only to the Pulse output mode of relay. This screen allows the user to set Relay energization time in milliseconds.

Pressing "▲" key accepts the present value and advance to "Pulse Rate" screen (see section 3.2.5.1.1.1.3). Similarly, pressing "▼" key accepts the present value and advance to "Parameter Selection" screen (see section 3.2.5.1.1.1.1).

Pressing the "■" key advances to "Pulse Duration Edit" mode and "▲" and "▼" keys scroll the value through **60, 100 and 200** ms.

Pressing the "■" key selects the value and advances to "Pulse Duration " menu (see Section 3.2.5.1.1.1.2).
NOTE: Default value is set to '100' ms.

3.2.5.1.1.1.3 Pulse Rate



This screen applies to the Pulse Output option only. The screen allows user to set the Energy Pulse Rate divisor. Divisor values can be selected through 1,10,100,1000 as per EnOP set. Refer **TABLE 4** for details.

Pressing "▲" key accepts the present selection and takes to the "Quit Pulse Output" menu (See section 3.2.5.1.1.1.4) and pressing "▼" key accepts the present selection and takes to the "Pulse Duration" screen (see Section 3.2.5.1.1.1.2).



Pressing the "■" key advances to "Pulse Rate Divisor Edit" mode & keys "▲" and "▼" scrolls the value through the values 1,10,100 and 1000.

Pressing the "■" key gives the "Pulse Rate" screen (see Section 3.2.5.1.1.1.3).

The default setting is '1'.

Note: If energy resolution is in kWh or Mwh then value is default 1.

3.2.5.1.1.1.4 Quit Pulse Output

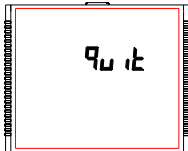

The screen allows user to exit the Pulse Output selection menu.

Pressing "▲" key advances to the "Pulse Output" menu (see Section 3.2.5.1.1.1) and pressing "▼" key advances to the "Pulse Rate" menu (See section 3.2.5.1.1.1.3).

Pressing "■" key advances to the "Relay Selection" menu (see Section 3.2.5.1.).

3.2.5.1.1.2.1 Limit Output Parameters

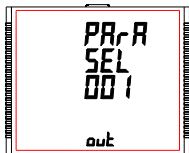

This screen is for **Limit output mode selection**. It allows the user to set Limit output corresponding measured value. Refer **TABLE 3** "Parameter for Limit output" for assignment.

Pressing "▲" key accepts the present parameter and for 37/38/39/40/41 as present value, advances to the "Energy Count Configuration" screen (see section 3.2.5.1.1.2.2) whereas for other values, advances to the "Parameter Configuration" screen (see Section 3.2.5.1.1.2.5). Whereas pressing "▼" key accepts the present parameter and advances to the "Quit Limit Output" screen (see section 3.2.5.1.1.2.10).

Pressing the "■" key advances to "Relay Output Selection" mode and "▲" and "▼" keys scrolls the values, as per **TABLE 3**, "Parameter for Limit Output".

Pressing the "■" key advances to "Limit Output Parameters" screen (see Section 3.2.5.1.1.2.1).

3.2.5.1.1.2.2 Energy Count Configuration

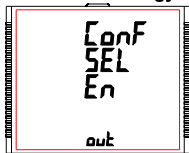

This screen is used to set the Limit Configuration for Energy Count.

Selecting 37/ 38/ 39/ 40/ 41 as Limit Output Parameter (see Section 3.2.5.1.1.2.1) allows the user select one of the following configurations:

En (To Energize the Relay)

d-En (To De-Energized the Relay)

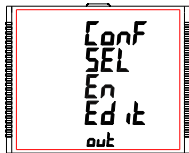

Pressing the "▲" key accepts the present selection and advances to the "Energy Trip Point" screen (see section 3.2.5.1.1.2.3) and pressing the "▼" key accepts the present selection and advances to the "Limit Output Parameters" screen (see section 3.2.5.1.1.2.1).

Pressing the "■" key advances to Energy Count Configuration edit mode and "▲" and "▼" keys scrolls through the modes available.

Pressing the "■" key sets the displayed value and advances to "Energy Count Configuration" Screen (see Section 3.2.5.1.1.2.2).

NOTE: Default configuration is set to 'En'.

3.2.5.1.1.2.3 Energy Trip Point

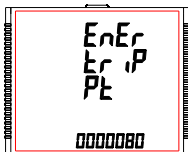

This screen is used to trip the relay using the energy count. The relay trips after the lapse of "ON Delay" time (see Section 3.2.5.1.1.2.4) from the moment the energy count reaches the value of Energy Trip Point set by the user in addition to its value at the moment the Energy Trip Point is set.

Pressing the "▲" key accepts the present value and advances to the "Energy Count ON Delay" screen (see Section 3.2.5.1.1.2.4) and pressing the "▼" key accepts the present value and advances to the "Energy Count Configuration" screen (see Section 3.2.5.1.1.2.2).

Pressing the "■" key advances to Energy Count Configuration edit mode.

Energy Count Configuration edit mode

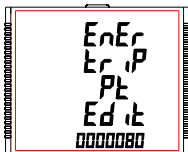

Press "■" key, prompt for the first digit.

Press the "▲" and "▼" keys to scroll the value between 0 and 9, whereas Press the "■" key to lock the present selection and advance to next digit.

Similarly, lock the value of all the remaining digits of the 7 digit count in a similar way until the last digit is reached.

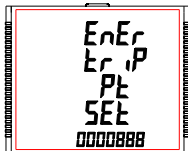

Pressing the "■" key for the last digit sets the value for Energy Trip Point.

For example, if the value set for Energy Trip Point is 888 and the value of the corresponding parameter at the moment this value is set is 1077, then the relay will trip after x sec of the moment the value of the parameter becomes 1965 (= 1077 + 888), where x is the ON Delay (see Section 3.2.5.1.1.2.4).

The value of Energy Trip Point can range from 10 to 9999999.

Default value is set to '10'.

⚠ Caution: Once the relay has tripped, then to reactivate the Energy Tripping function, the user has to either reset the energy or re-enter the energy count.

3.2.5.1.1.2.4 Energy Count ON Delay

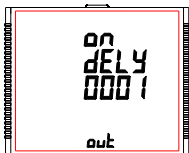

This screen allows the user to set ON Delay time in **seconds** for Relay Limit Assigned Parameter. Refer Section 3.2.5.1.1.2.3 for details.

Pressing "▲" key accepts the present value and advance to "Quit Limit Output" screen (see Section 3.2.5.1.1.2.10) and pressing "▼" key accepts the present value and advances to "Energy Trip Point" screen (see Section 3.2.5.1.1.2.3).

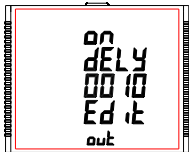

Press "■" key, prompt for the first digit.
Press the "▲" and "▼" keys to scroll the values of the first digit.
Press the "■" key to advance to next digit.

Similarly, enter second, third and fourth digits also.

After the fourth digit is entered, pressing "■" key sets the value and advances to "Energy Count ON Delay" screen (see Section 3.2.5.1.1.2.4).

The value for this parameter can range from 0001 to 9999 seconds.

Note: Default value is set to '1' second.

3.2.5.1.1.2.5 Parameter Configuration

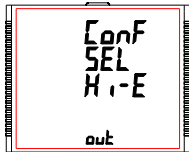

Selecting Limit Output Parameter (see Section 3.2.5.1.1.2.1) other than 37/ 38/ 39/ 40/ 41 allows the user select one of the following configurations:

- Hi - E (High Alarm & Energized Relay)
- Hi - d (High Alarm & De-Energized Relay)
- Lo - E (Low Alarm & Energized Relay)
- Lo - d (Low Alarm & De-Energized Relay)

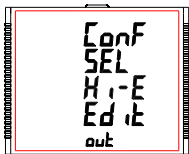

(For details refer to section 5.2)

Pressing the "▲" key accepts the present selection and advances to the "Trip Point" screen (see section 3.2.5.1.1.2.6) and pressing the "▼" key accepts the present selection and advances to the "Limit Output Parameters" screen (see section 3.2.5.1.1.2.1).

Pressing the "■" key advances to Parameter Configuration edit mode and "▲" and "▼" keys scrolls through the modes available.

Pressing the "■" key sets the selected config. and advances to "Limit Configuration" Screen (See section 3.2.5.1.1.2.2).

Note: Default configuration is set to 'Hi-E'.

3.2.5.1.1.2.6 Trip Point

This screen applies to the Trip point selection for parameters other than 37/38/39/40/41 selected in Section 3.2.5.1.1.2.1.

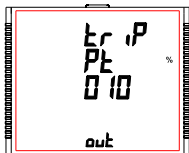

This screen allows the user to set Trip point for instruments. The allowable range is **10% to 120% for High Alarm, 10% to 100% for Low Alarm** (refer TABLE 3).

Pressing the "▲" key accepts the present value and advances to the "Hysteresis" screen (see section 3.2.5.1.1.2.7) and pressing the "▼" key accepts the present value and advances to the "Parameter Configuration" screen (see Section 3.2.5.1.1.2.5).

Press "■" to confirm and go to "Trip Point" screen (see Section 3.2.5.1.1.2.6).

Pressing "■" key prompts for first digit. Press the "▲" and "▼" keys to scroll the values of the first digit. Press the "■" key to advance to next digit. Similarly, enter second and third digits also.

Note: Default value is set to '10' %.

3.2.5.1.1.2.7 Hysteresis



This screen applies to the Hysteresis selection. This screen allows the user to set Hysteresis for relay output.

The allowable range is **0,5% to 50,0 %** of Trip point.

Pressing the "▲" key accepts the present value and advances to the "Energizing Delay" screen (see Section 3.2.5.1.1.2.8) and pressing the "▼" key accepts the present value and advances to the "Trip Point" screen (see Section 3.2.5.1.1.2.6).



Pressing "■" key prompts for first digit.

Press the "▲" and "▼" key to scroll the value of the first digit.

Press the "■" key to advance to next digit.

The second digit prompts. Press "▲" and "▼" keys to scroll through 0 and 9 and "■" key to set the digit and advance to the third digit. The third digit prompts. Press "▲" and "▼" keys to scroll through 0 and 9.

Press "■" to confirm the value and advance to "Hysteresis" screen (see Section 3.2.5.1.1.2.7). Refer Section 5.2 for further details.

Note: Default value is set to '0.5' %.

3.2.5.1.1.2.8 Energizing Delay

This screen allows the user to set Energizing Delay time in **seconds** for Relay Limit Assigned Parameters.

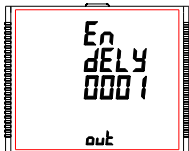

Pressing "▲" key accepts the present value and advances to "De-Energizing Delay" screen (see Section 3.2.5.1.1.2.9) and pressing "▼" key accepts the present value and advances to "Hysteresis" screen (see Section 3.2.5.1.1.2.7).

Pressing the "■" key advances to "Energizing Delay" Edit mode.

Pressing "■" key sets displayed value & advances to Assignment of "Energizing Delay" menu (See section 3.2.5.1.1.2.8).

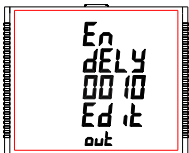

Pressing " " key prompts for first digit..

Press the "▲" and "▼" key to scroll the value of the first digit. Press the " " key to advance to second digit.

The second digit prompts. Press "▲" and "▼" keys to scroll through 0 and 9 and " " key to set the digit and advance to the third digit.

The third digit prompts. Press "▲" and "▼" keys to scroll through 0 and 9 and " " key to set the digit and advance to the fourth digit.

Press "▲" and "▼" keys to scroll through 0 and 9.
Press " " to confirm the value and advance to "Energizing Delay" screen (see Section 3.2.5.1.1.2.8).

The value of Energizing Delay can be set between **1** and **9999** seconds.

Note: Default value is set to '1' second.

3.2.5.1.1.2.9 De-Energizing Delay

This screen allows the user to set De-Energizing Delay time in **seconds** for Relay Limit Assigned Parameters.

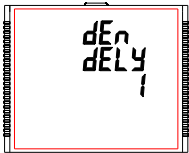

Pressing "▲" key accepts the present value takes to "Quit Limit Output" menu (See section 3.2.5.1.1.1.2.10).

Similarly, pressing "▼" key accepts the present value takes to "Energizing Delay" menu (See section 3.2.5.1.1.1.2.8).

Pressing the " " key advances to "De-Energizing Delay" Edit mode.

Pressing " " key sets displayed value and takes back to "De-Energizing Delay" screen (see Section 3.2.5.1.1.2.9).

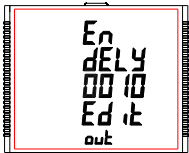

Pressing " " key prompts for first digit.

Press the "▲" and "▼" key to scroll the value of the first digit.

Press the " " key to advance to second digit.

The second digit prompts. Press "▲" and "▼" keys to scroll through 0 and 9 and " " key to set the digit and advance to the third digit.

The third digit prompts. Press "▲" and "▼" keys to scroll through 0 and 9 and " " key to set the digit and advance to the fourth digit.

Press "▲" and "▼" keys to scroll through 0 and 9.

Press " " key to confirm the value and advance to "De-Energizing Delay" screen (see Section 3.2.5.1.1.2.9).

The value of De-Energizing Delay can be set between **1** and **9999** seconds.

Note: Default value is set to '1' second.

3.2.5.1.1.2.10 Quit Limit Output

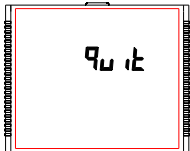

The screen allows user to exit the Relay output selection menu.

Pressing "▲" key advances to "Limit Output" menu (See section 3.2.5.1.1.2) and pressing "▼" key advances to "De-Energizing Delay" menu (see Section 3.2.5.1.1.2.9) if Limit Output Parameter (see Section 3.2.5.1.1.2.1) set is not 37/38/39/40/41, otherwise it advances to "Energy Count ON Delay" screen (see Section 3.2.5.1.1.2.4).

Pressing "■" key advances to "Relay Selection" menu (see Section 3.2.5.1).

3.2.5.1.1.3.1 Number of Cycles

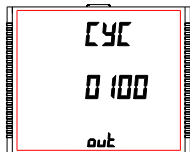

The value decides how many times the timer will repeat the switching after it has been started in the **timer based relay output option**.

Pressing "▲" key confirms the value and advances to the "Timer Configuration" menu (See section 3.2.5.1.1.3.2) and pressing "▼" key advances to "Timer" menu (See section 3.2.5.1.1.3).

The value for this **parameter can range from 0000 to 9999**. If the value is set as 0000, the timer will keep repeating the cycles until 9999 cycles are complete or the timer is stopped by the user. Refer Section 5.3 for more details.

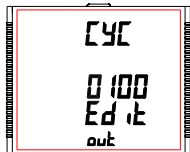

Press "■" key, prompt for the first digit.

Press the "▲" and "▼" keys to scroll the values of the first digit.

Press the "■" key to advance to next digit.

Similarly, enter second, third and fourth digits also.

After the fourth digit has been entered, pressing "■" key sets the value and advances to "Number of Cycles" screen (see Section 3.2.5.1.1.3.1).

The default setting is '10' cycles.

3.2.5.1.1.3.2 Timer Configuration

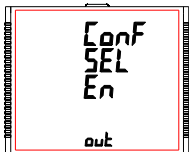

The option decides the relay configuration for timer output. Two options are available:

1. **En** : Energize on start
2. **d-En** : De-energize on start.

Pressing "▲" key confirms the selection and advances to the "On Delay" menu (See section 3.2.5.1.1.3.3) and pressing "▼" key advances to the "Number of Cycles" menu (See section 3.2.5.1.1.3.1).

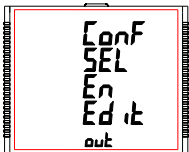

Press "■" key to enter the edit mode and press "▲" and "▼" keys to navigate between the options.

Pressing "■" key sets the selected config. and advances to the Timer Configuration menu (see Section 3.2.5.1.1.3.2).

The default setting is 'En'.

3.2.5.1.1.3.3 On Delay



The value decides the time in seconds taken by the relay in timer configuration before tripping after it is started.

Pressing "▲" key confirms the value and advances to the "Off Delay" menu (See section 3.2.5.1.1.3.4) and pressing "▼" key advances to the "Timer Configuration" menu (See section 3.2.5.1.1.2).

Press "■" key, prompt for the first digit.

Press the "▲" and "▼" keys to scroll the values of the first digit.

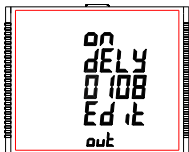

Press the "▬" key to advance to next digit. Similarly, enter second, third and fourth digits also. After the fourth digit is entered, pressing "▬" key sets the value and advances to "On Delay" screen (see Section 3.2.5.1.1.3.3).

The value for this **parameter can range from 0001 to 9999** seconds. The default value is '10' seconds.

3.2.5.1.1.3.4 Off Delay



The value decides the time in seconds taken by the relay in timer configuration before coming out of the trip state after it has tripped.

Pressing "▲" key confirms the value and advances to the "Quit Timer Output" menu (See section 3.2.5.1.1.3.5) and pressing "▼" key advances to the "On Delay" menu (See section 3.2.5.1.1.3.3).

Press "▬" key, prompt for the first digit. Press the "▲" and "▼" keys to scroll the values of the first digit.

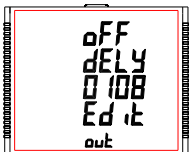

Press the "▬" key to advance to next digit.

Similarly, enter second, third and fourth digits also. After the fourth digit has been entered, pressing "▬" key sets the value and advances to Off Delay screen (see Section 3.2.5.1.1.3.4).

The value for this parameter can range from **0001 to 9999** seconds.

The default value is '10' seconds.

3.2.5.1.1.3.5 Quit Timer Output

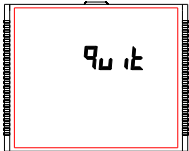

The screen allows user to exit the Timer output menu.

Pressing "▲" key advances to the "Timer Output" menu (see Section 3.2.5.1.1.3) and pressing "▼" key advances to "Off Delay" menu (see Section 3.2.5.1.1.3.4).

Pressing "■" key advances to "Relay Selection" menu (see Section 3.2.5.1).

3.2.5.1.1.4 RTC Relay

3.2.5.1.1.4.1 Weekdays Selection

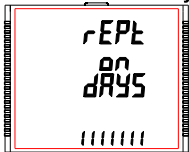

This screen allows user to select the days of the week on which the relay behaves as configured for RTC Relay settings.

Pressing "▲" key confirms the selection and advances to the "Relay Configuration" menu (See section 3.2.5.1.1.4.2) and pressing "▼" key advances to the "RTC Relay" menu (See section 3.2.5.1.1.4).

Pressing "■" key advances user to the "Edit Weekdays" mode where the user can edit the working weekdays selection.

Edit Weekdays

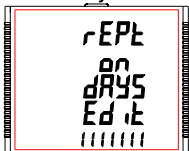

Press "■" key, prompt for the first digit.

The first digit at the lower row of the screen represents SUNDAY. Press the "▲" and "▼" keys to scroll the value between 0 and 1, where 0 : Relay is not activated for the weekday selected 1 : Relay is active for the weekday selected.

Press the "■" key to lock the present selection and advance to next digit representing MONDAY.



Lock the selection for **all** the remaining days, **till** selection for the **last** day, i.e., SATURDAY, is reached.

Once the selection for SATURDAY is set by pressing " **■** " key, the "Weekdays Selection" screen appears again (see Section 3.2.5.1.1.4.1) and sets the days for relay to be active/deactive.

The default setting is '1111111' i.e., active for all the days.

3.2.5.1.1.4.2 Relay Configuration

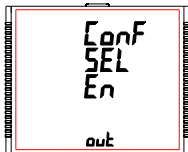

The option decides the relay configuration in timer mode. Two options are available:

1. **En** : Energize on start
2. **d-En** : De-energize on start.

Pressing " **▲** " key confirms the selection and advances to the "On Time" menu (See section 3.2.5.1.1.4.3) and pressing " **▼** " key confirms the selection and advances to "Weekdays Selection" menu (see Section 3.2.5.1.1.4.1).

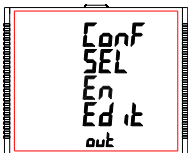

Press " **■** " key to enter the edit mode and press " **▲** " and " **▼** " keys to navigate between the options.

Pressing " **■** " key sets the selected option and advances to Relay Configuration menu (see Section 3.2.5.1.1.4.2).

The default setting is 'En', i.e., energized on start.

3.2.5.1.1.4.3 ON Time

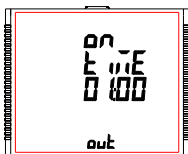

On Time is the time at which the relay becomes active.
The time is displayed in HH:MM format and its **range is 00:00 to 23:59**.

Pressing "▲" key confirms the value and advances to the "OFF Time" menu (See section 3.2.5.1.1.4.4) and pressing "▼" key advances to the "Relay Configuration" menu (See section 3.2.5.1.1.4.2).

Pressing "■" key advances to the Edit ON Time option.

Edit ON Time

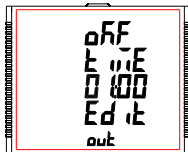

Press "■", prompt for 10's place of HH.
Press "■", prompt for 1's place of HH.
Press "■", prompt for 10's place of MM.
Press "■", prompt for 1's place of MM.

Keys "▲" and "▼" are used to change the corresponding values.

Pressing "■" key confirms the selection and advances to the "ON Time" menu (see Section 3.2.5.1.1.4.3).
The default setting is '06:00', i.e., 6 A.M.

3.2.5.1.1.4.4 OFF Time

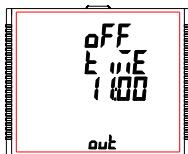

OFF Time is the time at which the relay deactivates.
The time is displayed in HH:MM format and its **range is 00:00 to 23:59**.

Pressing "▲" key confirms the value and advances to the "Quit RTC Output" menu (See section 3.2.5.1.1.4.5) and pressing "▼" key advances to the "ON Time" menu (See section 3.2.5.1.1.4.3).

Pressing "■" key advances to the "Edit OFF Time" option.

Edit OFF Time

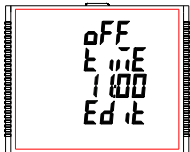

Press " ", prompt for 10's place of HH.
Press " ", prompt for 1's place of HH.
Press " ", prompt for 10's place of MM.
Press " ", prompt for 1's place of MM.

Keys "▲" and "▼" are used to change the corresponding values.

Pressing " " key confirms the selection and advances to the "OFF Time" menu (see Section 3.2.5.1.1.4.4).

The default setting is '18:00' i.e., 6 P.M.

3.2.4.1.1.4.5 Quit RTC Output

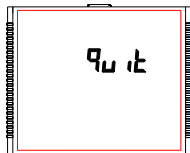

The screen allows user to exit the RTC output menu.

Pressing "▲" key advances to the "RTC Output" menu (see Section 3.2.5.1.1.4) and pressing "▼" key advances to the "OFF Time" menu (see Section 3.2.5.1.1.4.4).

Pressing " " key advances to the "Relay Selection" (see Section 3.2.5.1).

3.2.6 Datalog Option Selection

3.2.6.1 Event Based Datalog Setup



This screen is used to enter into event datalogging feature.

Pressing the "▲" key advances to the "Time Based Datalog" menu (see Section 3.2.6.2) and pressing the "▼" key takes to the "Quit Datalog Option" menu (see Section 3.2.6.4).

Pressing the " " key advances to the Event Based datalog selection and pressing the "▲" and "▼" key scrolls through the options available:

datalog : YES/no (see Section 3.2.6.1.1)

quit : to exit Event Datalog Selection (see Section 3.2.6.1.2)

3.2.6.1.1 Event Based Datalog Selection



This screen is used to start or stop event datalogging.

Pressing the " — " key allows the user to start or stop event based datalogging by selecting "YES" or "no", respectively using " ▲ " and " ▼ " keys.

Once the required option is selected, pressing the " — " key sets the selection and advances to the Event Based Datalog selection screen (see Section 3.2.6.1.1).

3.2.6.1.2 Quit Event Datalog

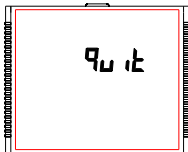

This screen is used to exit event based datalog selection.

Pressing the " — " key advances to the Event Based Datalog setup screen (see Section 3.2.6.1).

3.2.6.2 Time Based Datalog Setup



This screen is used to enter into time based datalog feature.

Pressing the " ▲ " key takes to the "Load Profile Datalog" menu (see section 3.2.6.3) and pressing the " ▼ " key takes to the "Event Based Datalog" menu (see section 3.2.6.1).

Pressing the " — " key advances to Time Based datalog selection and pressing " ▲ " and " ▼ " keys scrolls through various parameters related to time based datalogging (see Section 3.2.6.2.1 to Section 3.2.6.2.5).

3.2.6.2.1 Time Based Datalog Selection



This screen is used to start or stop time based datalogging.

Pressing the "▲" key confirms the selection and advances to "Time Interval Selection" screen (see Section 3.2.6.2.2) and pressing the "▼" key confirms the selection and advances to "Quit Time Based Logging" screen (see Section 3.2.6.2.5).

Pressing the "■" key allows the user to start or stop time based datalogging by selecting "YES" or "no", respectively using "▲" and "▼" keys.

Pressing the "■" key sets the selection and if the selection is "YES", then "Pls Wait" screen appears followed by "Time Based Datalog Selection" screen (see Section 3.2.6.2.1).

⚠ Caution: The settings for time based logging (see Section 3.2.6.2.2 - Section 3.2.6.2.4) are not editable if time based datalog selection is set to YES (see Section 3.2.6.2.1).

3.2.6.2.2 Time Interval Selection

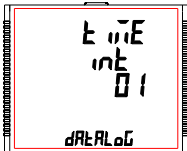

This screen is used to decide the time interval between two successive time datalog entries.

The allowable range is 01 - 60 minutes.

Pressing the "▲" key confirms the selection and advances to "Parameter Count" screen (see Section 3.2.6.2.3) and pressing the "▼" key confirms the selection and advances to "Time Based Datalog Selection" screen (see Section 3.2.6.2.1).

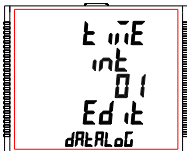

Press "■" to enter different time interval, it prompts for first digit. Press the "▲" and "▼" keys to scroll the value of the first digit. Press the "■" key to advance to next digit.

Similarly, enter the second digit of interval. After entering second digit, pressing "■" key sets the value and advances to the "Time Interval Selection" screen (see Section 3.2.6.2.2).

The default value is '1' second.

3.2.6.2.3 Parameter Count



This screen is used to decide the number of parameters that will be logged in time based datalogging. The allowable range is 01 - 30.

Pressing the "▲" key confirms the selection and advances to "Parameter Selection" screen (see Section 3.2.6.2.4) and pressing the "▼" key confirms the selection and advances to "Time Interval Selection" screen (see Section 3.2.6.2.2).

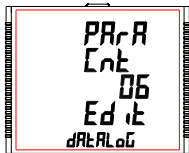

Press "—" to enter the parameter count, prompt for first digit.

Press the "▲" and "▼" keys to scroll the value of the first digit. Press the "—" key to advance to next digit.

Similarly, enter the second digit of interval. After entering second digit, pressing "—" key sets the value and advances to the "Parameter Count" screen (see Section 3.2.6.2.3). The default value is '1'.

3.2.6.2.4 Parameter Selection

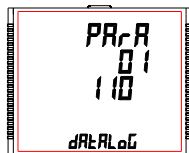

This screen is used to select the measurement parameters to be recorded. The allowable values are shown in Table 5.

For each of the parameter count set in Section 3.2.6.2.3, the corresponding parameter number (Refer Table 5) can be set by the user.

Pressing "▲" key confirms the selection and allows the user to proceed for setting the next parameter until the last parameter is set which is followed by the "Quit Time Based Datalog" screen (see Section 3.2.6.2.5).

Where as pressing the "▼" key confirms the selection and takes to the previous parameter set until the first parameter is reached which is followed by the "Parameter Count" screen (see Section 3.2.6.2.3).



Press " " to enter the parameter selection.

Press the " ▲ " and " ▼ " keys to scroll the value of the measurement parameter number in decreasing and increasing order, respectively. Pressing " " key sets the value and take user to the "Parameter Selection" screen (see Section 3.2.6.2.4) for the parameter set.

The default value is '000', i.e. no parameter to be logged.

3.2.6.2.5 Quit Time Based Datalog

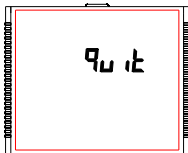

This screen is used to exit time based datalog selection.

Pressing the " " key advances to the "Time Based Datalog Setup" screen (see Section 3.2.6.2).

3.2.6.3 Load Profile Datalog Setup



This screen is used to enter into Load Profile datalog feature.

Pressing the " ▲ " key takes to the "Quit Datalog Option" menu (see Section 3.2.6.4) and pressing the " ▼ " key advances to "Time Based Datalog Setup" (see Section 3.2.6.2).

Pressing the " " key advances to the Load Profile datalog selection and pressing the "▲" and "▼" key scrolls through the options available:
datalog : YES/no (see Section 3.2.6.3.1)
quit : to exit Load Profile Datalog selection (see Section 3.2.6.3.2)

3.2.6.3.1 Load Profile Datalog Selection



This screen is used to start or stop Load Profile datalogging.

Pressing the " — " key allows the user to start or stop Load Profile datalogging by selecting "YES" or "no", respectively using " ▲ " and " ▼ " keys.

Pressing the " — " key sets the selection and if the selection is "YES", then "Pls Wait" screen appears followed by "Load Profile Datalog Selection" screen (see Section 3.2.6.3.1). If the selection is "no", then "Pls Wait" screen does not appear.

⚠ Caution: If any setting is done by user which resets energy or demand parameter it will reset load profile data.

3.2.6.3.2 Quit Load Profile Datalog Selection

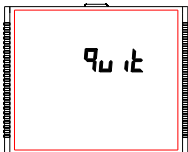

This screen is used to exit Load Profile datalog selection.

Pressing the " — " key advances to the "Load Profile Datalog Setup" screen (see Section 3.2.6.3).

3.2.6.4 Quit Datalog Option



The screen allows user to exit the Datalog Option menu.

Pressing " ▲ " key advances to the "Event Based Datalog" menu (see Section 3.2.6.1) and pressing " ▼ " key advances to the "Load Profile Datalog Setup" menu (see Section 3.2.6.3).

Pressing " — " key advances to the "Datalog Option Selection Menu"(see Section 3.2.6).

3.2.7 Display Parameters

3.2.7.1 Feature Selection Menu



This menu allows the user to scroll through different Display Configurable features:

bCLt : backlit on/off

Scrn : user screen on/off

Cont : Contrast level



quit : to exit Display Parameters screen



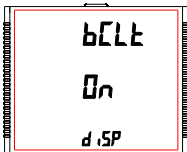

Pressing the "  " key advances to the listed features (see Section 3.2.7.1.1 to Section 3.2.7.1.3).

3.2.7.1.1 Backlit







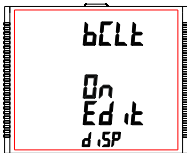

This screen allows the user to switch the backlit on or off.

Pressing the "  " and "  " keys advances to "User Assignable Screens" (see Section 3.2.7.1.2) and "Quit Display Parameters" menu (see Section 3.2.7.1.4), respectively.

Pressing the "  " key shows the present status as on/OFF and pressing "  " key allows editing it whereas "  " and "  " keys advance to the "Backlit" menu (see Section 3.2.7.1.1).



In Edit Mode, pressing "  " and "  " keys allows the user to scroll between On/OFF and pressing "  " key confirms the selection.

Pressing "  " key again advances to editing mode whereas pressing "  " or "  " keys advances to "Backlit" menu (see Section 3.2.7.1.1).

Note: When backlit is switched 'Off', on pressing any key backlit will turn 'On' for 1 min.

Default value is set to 'On'.

3.2.7.1.2 User Assignable Screens



This screen allows the user to turn enable or disable the User Screen feature.

Using this feature, the user can select upto 10 measurement screens of his choice and scroll through only those selected screens.

Pressing the " = " key allows the user to advance to the "Screen Number Selection" menu (see Section 3.2.7.1.2.1) whereas pressing the " ▲ " and " ▼ " keys advances to "Backlit" menu (see Section 3.2.7.1.3) and "Contrast" menu (see Section 3.2.7.1.1), respectively.

3.2.7.1.2.1 Screen Number Selection

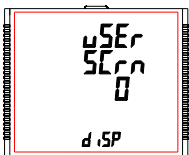

Pressing the " ▲ " key sets the present value for the number of screens to be shown and advance towards the "User Screens Selection" menu (see Section 3.2.7.1.2.2) whereas pressing the " ▼ " key sets the present value and advance to "Quit Userscreens" menu (see Section 3.2.7.1.2.3).

Pressing " = " key allow the user to set a different value for the number of user assignable screens using " ▲ " and " ▼ " keys.

The user can set the number of screens from 1 to 10.

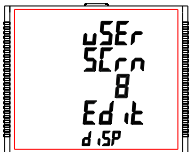

Pressing " = " key sets the selected value and advances to "Screen Number Selection" screen (see Section 3.2.7.1.2.1).

- Note:**
1. The value 0 should be chosen if the user wants all the screens to be shown.
 2. If User Screen feature is ON and System type is changed, then the Userscreen is disabled.

The default setting is '0', i.e., all screens are shown.

3.2.7.1.2.2 User Screens Selection

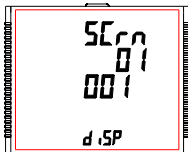

Pressing the "▲" key confirms the selection and allows the user to proceed for setting the next userscreen until the last userscreen is set which is followed by the "Quit UserScreens" menu (see Section 3.2.7.1.2.3).

Whereas pressing the "▼" key confirms the selection and take to the previous userscreen set until the first userscreen is reached which is followed by the "Screen Number Selection" screen (see Section 3.2.7.1.2.1).

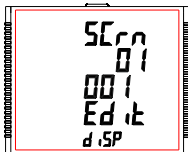

Pressing the "■" key advances the User Screen Edit mode and pressing "▲" and "▼" keys scroll the value as per TABLE 1/TABLE 2 "Measurement Screens".

Pressing "■" key sets the displayed value & advance to User Screen Selection (see Section 3.2.7.1.2.2) for the corresponding screen number.

3.2.7.1.2.3 Quit Userscreens

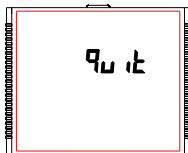

This screen is used to exit User defined Screen selection.

Pressing the "■" key advances to the "User Assignable Screens" menu (see Section 3.2.7.1.2).

3.2.7.1.3 Contrast



This screen allows the user to set the contrast for the display.

Pressing the "▲" and "▼" keys advances to "Quit Display" menu (see Section 3.2.7.1.4) and "User Assignable Screens" menu (see Section 3.2.7.1.2), respectively.

Pressing the "■" key shows the present contrast value and pressing "■" key again will allow editing it whereas "▲" and "▼" keys advances to the "Contrast" menu (see Section 3.2.7.1.3).

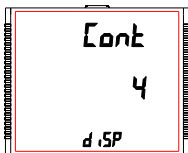

In Edit Mode, pressing "▲" and "▼" keys allows the user to scroll between **contrast levels ranging from 1 to 4** and pressing "■" key confirms the selection.

Pressing "■" key advances to editing mode whereas pressing "▲" or "▼" keys advances to the "Contrast" menu (see Section 3.2.7.1.3). Default value is set to '3'.

3.2.7.1.4 Quit Display Parameters

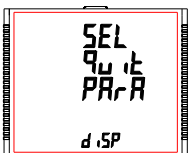

This screen allows user to Exit from User Assignable Feature selection setup.

Pressing the "▲" key advances to "Backlit" screen. (see Section 3.2.7.1.1). Whereas pressing the "▼" key advances to "Contrast" screen. (see Section 3.2.7.1.3).

Pressing the "■" key advances to "Display Parameters" (see Section 3.2.7).

3.2.8 RTC Setting Screen

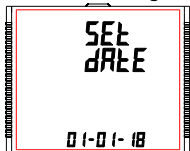

This screen allows the user to set date and time for the device RTC.

Pressing " " advances to Date Settings (see Section 3.2.8.1) and pressing "▲" and "▼" keys advances to Time Settings (see Section 3.2.8.2) and "Quit RTC" screen (see Section 3.2.8.3), respectively.

3.2.8.1 Date Settings

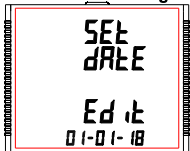

This screen allows the user to set the date for device RTC.

The date is displayed in DD-MM-YY format in the settings and its **range is 01-01-00 to 31-12-99** (for the 21st century, i.e., YY = 00 represents 2000 and YY = 99 represents 2099).

Press " ", prompt for DD.

Press " ", prompt for MM.

Press " ", prompt for YY.

Keys "▲" and "▼" are used to change the values of DD, MM and YY. After YY is set, pressing " " advances to "Pls Wait" screen followed by "Date Settings" screen (see Section 3.2.8.1).

▲ Caution : If date setting is changed then load profile log data will reset

3.2.8.2 Time Settings

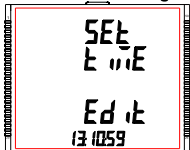

This screen allows the user to set the time for device RTC.

The date is displayed in HH:MM:SS format in the settings and its **range is 00:00:00 to 23:59:59**.

Press " ", prompt for 10's place of HH.

Press " ", prompt for 1's place of HH.

Press " ", prompt for 10's place of MM.

Press " ", prompt for 1's place of MM.

Press " ", prompt for 1's place of SS

Press " ", prompt for 1's place of SS

Keys "▲" and "▼" are used to change the corresponding values.

After 1's place of SS is set, pressing " " advances to "Time Settings" screen (see Section 3.2.8.2).

3.2.8.3 Quit RTC

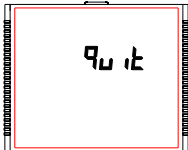

This screen allows user to Exit from RTC settings.

Pressing the "▲" key advances to "Date Settings" screen. (see Section 3.2.8.1). Whereas pressing the "▼" key advances to "Time Settings" screen (see Section 3.2.8.2).

Pressing the "■" key advances to "RTC Setting screen" (see Section 3.2.8).

3.2.9 Factory Reset Screen

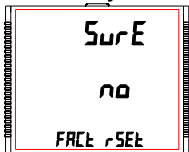

This screen allows the user to erase all data from the meter and set all setup parameters to their default values.

Pressing the "■" key advances to the "Sure" (confirmation) screen which displays a "no".

Pressing "▲" or "▼" key advances to Factory Reset Screen (see Section 3.2.9).

Whereas pressing "■" key advances to the Factory Reset selection screen.

Factory Reset selection screen

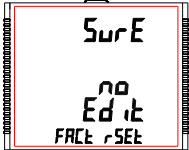

Pressing "▲" or "▼" key allows the user to select between "YES" or "no".

YES : Allow Factory Reset

no : Don't allow Factory Reset

Pressing "■" accepts the selection and if the selection is "YES", advances to "Pls Wait" screen followed by the "Sure" screen of "Factory Reset Screen" (see Section 3.2.9). If the selection is "no", then "Pls Wait" screen does not appear.

3.2.10 Quit



This screen allows the user to set the meter to exit the setup menu.

Pressing “ - ” key quits from the Setup menu and advance to measurement screen at which the setup screen was accessed.

4. Energy Auto-Ranging On Display :

4.1 Calculating Display energy (Auto-ranging):

In case of energy auto-ranging the energy shown on modbus will be in terms of Overflow count (OF) & main energy counter (M) based on energy resolution & energy digit reset count (EDRC). So energy on modbus will have unit set in energy resolution on modbus (ie. Wh or kWh or MWh) & overflow energy counter (OF) on modbus will increment when main energy counter (M) on modbus will cross the number of digits set in energy digit reset count (EDRC) register (ie 7 or 8 or 9).

Whereas energy shown on display will be Combined energy (ie. Calculated from overflow count (OF) on modbus & main energy Count (M) on modbus) autoranged based on the 9 digits available on display to show energy.

Hence the purpose of this document is to establish a relation between modbus energy counters & display energy.

$$\text{Total Energy} = \text{OF} \times 10^{\text{EDRC}} + \text{M}$$

Where:

OF => Overflow Count on modbus

Modbus registers for Overflow count (OF):

Wh import Overflow count => 30109 Or 40109

Wh export Overflow count => 30113 Or 40113

VARh Capacitive Overflow count => 30117 Or 40117

VARh Inductive Overflow count => 30121 Or 40121

Vah Overflow count => 30125 Or 40125

M => Main Energy Counter on modbus

Modbus registers for Main energy Count (M):

Wh import => 30111 Or 40111
Wh export => 30115 Or 40115
VARh Capacitive => 30119 Or 40119
VARh Inductive => 30123 Or 40123
Vah => 30127 Or 40127

EDRC => Energy digit reset count set by user from display or modbus
For display setting refer Section 3.2.1.12.
For modbus refer Register 46039

Example for Calculating Display Energy from modbus Energy Counters:

Energy resolution on modbus register 46005 is set to 2 (ie. It will measure energy in kWh).

Overflow count (OF) value on modbus register 30109 for watt Import is 25.

Energy main counter (M) value on modbus register 30111 for watt import is 2587413.189

Energy digit reset count (EDRC) set by user in modbus register 46039 is 8.
Then,

$$\begin{aligned}\text{Total Energy} &= 25 \times 10^8 + 2587413.189 \\ &= 2500000000 + 2587413.189 \\ &= 2502587413.189 \text{ kWh}\end{aligned}$$

Therefore Energy shown on display will be:
= 2502587.41 MWh

As maximum number of digits for displaying energy present on display is 9 and the value of Total Energy in above example exceeds 9 counts so Energy in kWh is converted to MWh for displaying as shown above.

Note: As maximum energy shown on the display is XXXXXXXXXX (9 Count) MWh so if count of above calculation for Total energy exceeds XXXXXXXXXX (9 Count) MWh then the display will show "—OF—" with unit MWh that indicates display energy has overflow. This condition will only get reset if the Total Energy Count gets reset.

Overflow count (OF) on modbus will reset to 0 if it exceeds 99999999 in case of Wh resolution, 99999 in case of kWh resolution & 99 in case of Mwh resolution.

4.2 Entering Energy start count:

(Applicable for meter with modbus or Ethernet)

Energy start count is the feature that allows user to set count from which the meter should start incrementing energy. The start count can be set for main energy start counter & Overflow energy start Counter separately from modbus or Ethernet. Setting of energy start count is dependent on Energy resolution & Energy digit reset count (EDRC).

Energy resolution on modbus can be set by user from display (Refer page 29 of user manual) or from modbus (refer modbus register 46005).

Value for Energy resolution can be set to Wh,kWh or MWh.

Minimum resolution of energy that can be set in energy start count register is, the Energy resolution set by user.

For Eg.: Energy start count can be set to minimum 1Wh if the value on modbus register 46005 is set to Wh Or Energy start count can be set to minimum 1MWh if the value on modbus register 46005 is set to MWh.

Maximum value that can be set in the main energy start count register is $(10^{(EDRC)}-1)$.

Where:

EDRC => Energy digit reset count set by user from display or modbus

For display setting refer Section 3.2.1.12.

For modbus refer Register 46039

Example for calculating maximum limit of main energy start count :

If EDRC is 7 then Maximum value that can be set in the main energy start count (M) register is

$$\begin{aligned} &= (10^{(EDRC)}-1) \\ &= ((10^7)-1) \\ &= (10000000-1) \\ &= 9999999 \end{aligned}$$

Similarly if EDRC is 8 the maximum value is 99999999 & if EDRC is 9 maximum value is 999999999.

Maximum value that can be set in the Overflow energy start count register is 99999999 for Wh renergy resolution ,99999 for kWh energy resolution ,99 for MWh resolution.

Note: Energy start Count can only be entered in integer value.

5. Relay Output:

The Meter is provided with relay for pulse output, for limit switch, as a Timer as well as RTC Relay.

5.1 Pulse Output :

Pulse Output is the potential free, very fast acting relay contact which can be used to drive an external mechanical counter for energy measurement. The Pulse Output can be configured to any of the following parameter through setup parameter screen:

3) Capacitive Reactive Energy

1) Active Energy (Import)

2) Active Energy (Export)

4) Inductive Reactive Energy

5) Apparent Energy

TABLE 4 : Energy Pulse Rate Divisor

1.For Energy Output in Whr

Divisor	Pulse rate	
	Pulse	System Power*
1	1 per Whr	Up to 3600 W
	1 per kWhr	Up to 3600 kW
	1 per MWhr	Above 3600 kW up to 30000 kW
10	1 per 10Whr	Up to 3600 W
	1 per 10kWhr	Up to 3600 kW
	1 per 10MWhr	Above 3600 kW up to 30000 kW
100	1 per 100Whr	Up to 3600 W
	1 per 100kWhr	Up to 3600 kW
	1 per 100MWhr	Above 3600 kW up to 30000 kW
1000	1 per 1000Whr	Up to 3600 W
	1 per 1000kWhr	Up to 3600 kW
	1 per 1000MWhr	Above 3600 kW up to 30000 kW
Pulse Duration 60 ms, 100 ms or 200 ms		

2.For Energy Output in kWhr

Divisor	Pulse rate	
	Pulse	System Power*
1	1 per kWhr	Up to 3600 kW
	1 per MWhr	Above 3600 kW

3.For Energy Output in MWhr

Divisor	Pulse rate	
	Pulse	System Power*
1	1 per MWhr	Up to 3600 kW

Above options are also applicable for Apparent and Reactive Energy.

*Note:

- 1) System power = $3 \times CT(\text{Primary}) \times PT(\text{Primary})$ L-N for 3 Phase 4 Wire
- 2) System power = $\text{Root}3 \times CT(\text{Primary}) \times PT(\text{Primary})$ L-L for 3 Phase 3 Wire
- 3) System power = $CT(\text{Primary}) \times PT(\text{Primary})$ L-N for 1 Phase 2 Wire

5.2 Limit Switch :

Limit switch can be used to monitor the measured parameter (Ref. **TABLE 3**) in relation with to a set limit. The limit switch can be configured in one of the four mode given below:-

- | | |
|-------------------------------|----------------------------------|
| 1) Hi alarm & Energized Relay | 2) Hi alarm & De-Energized Relay |
| 3) Lo alarm & Energized Relay | 4) Lo alarm & De-Energized Relay |

With User selectable Trip point, Hysteresis, Energizing Delay & De-Energizing delay.

Hi Alarm:

If Hi-Alarm Energized or Hi Alarm De-Energized option is selected then relay will get energized or De-energized, if selected parameter is greater than or equal to trip point.

Lo Alarm:

If Lo-Alarm Energized or Lo Alarm De-Energized option is selected then relay will get energized or De-energized, if selected parameter is less than or equal to trip point.

Note: For Lo-Alarm configuration, set the values of trip point & hysteresis such that % trip point + % hysteresis should be less than 100% Value.

Example for Phase angle:

If trip point is set 70% then maximum applicable hysteresis is 42.8%. i.e Trip point 70% (252°) + Hysteresis 42.8% (107.8°) = 359.8° If total value is greater than the 100% i.e. 360° then relay will not release.

Example for PF:

For Hi-Alarm Energized, if trip point is 70% & hysteresis is 30%, then trip value = $0.7 \times 90^\circ = 63^\circ$. Tripping PF = $\cos(63) = 0.4539$ & hysteresis = $0.3 \times 0.4539 = 0.136$.

Hence, the relay will energize above 0.4539 and de-energize below 0.3179.

Note: This function will work irrespective of +/- sign. It depends only on value.

Trip point:

Trip point can be set in the range as specified in **TABLE 3** of nominal value for Hi-Alarm & 10% to 100% of nominal value for Lo-Alarm.

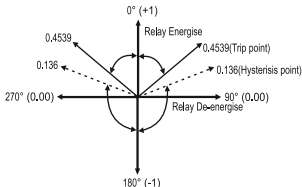

Hysteresis:

Hysteresis can be set in the range of 0.5% to 50 % of set trip point. If Hi-alarm Energized or Hi-alarm De-energized is selected then relay will get De-energized or Energized respectively, if set parameter value is less than Hysteresis. Similarly if Lo-alarm Energized or Lo-alarm De-Energized.

Note : In case of lo alarm if trip point is set greater than 80% then the maximum hysteresis can be set such that the total Trip point+ Hysteresis(% of trip point value) will not exceed 120% of range.

For example :If trip point is set at 90%, then maximum 33.3% hysteresis should be set such that, $[90 + 29.99 (33.3\% \text{ of } 90)] = 120$.

Energizing Delay:

The energizing delay can be set in the range from 1 to 9999 seconds.

De-Energizing Delay:

The De-energizing delay can be set in the range from 1 to 9999 seconds.

Examples of different configurations

Parameter No. 4 (Current1)

Trip Point = 50%

Hysteresis = 50% of trip point

Energising Delay: 2 sec

De-energising Delay: 2 sec

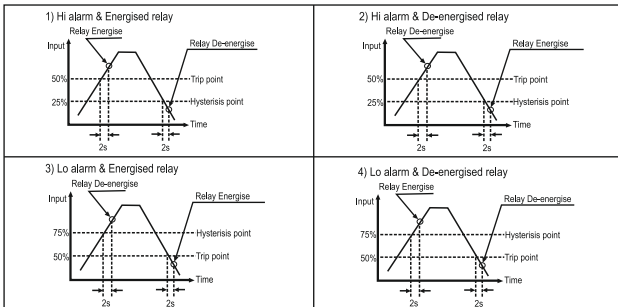

TABLE 3 : Parameters for Limit output

Parameter No.	Parameter	3P 4W	3P 3W	1P 2W	Trip Point Set Range	100% Value
0	None	✓	✓	✓	-	-
1	Volts 1	✓	✓	✓	10 - 120 %	Vnom (L-N)
2	Volts 2	✓	✓	✗	10 - 120 %	Vnom (L-N)
3	Volts 3	✓	✓	✗	10 - 120 %	Vnom (L-N)
4	IL1	✓	✓	✓	10 - 120 %	Inom
5	IL2	✓	✓	✗	10 - 120 %	Inom
6	IL3	✓	✓	✗	10 - 120 %	Inom
7	W1	✓	✗	✓	10 - 120 %	Nom ⁽³⁾
8	W2	✓	✗	✗	10 - 120 %	Nom ⁽³⁾
9	W3	✓	✗	✗	10 - 120 %	Nom ⁽³⁾
10	Va1	✓	✗	✓	10 - 120 %	Nom ⁽³⁾
11	Va2	✓	✗	✗	10 - 120 %	Nom ⁽³⁾
12	Va3	✓	✗	✗	10 - 120 %	Nom ⁽³⁾
13	Var1	✓	✗	✓	10 - 120 %	Nom ⁽³⁾
14	Var2	✓	✗	✗	10 - 120 %	Nom ⁽³⁾
15	VAr3	✓	✗	✗	10 - 120 %	Nom ⁽³⁾
16	PF1 # *	✓	✗	✓	10 - 90 %	90°
17	PF2 # *	✓	✗	✗	10 - 90 %	90°
18	PF3 # *	✓	✗	✗	10 - 90 %	90°
19	PA1 # *	✓	✗	✓	10 - 90 %	360°
20	PA2 # *	✓	✗	✗	10 - 90 %	360°
21	PA3 # *	✓	✗	✗	10 - 90 %	360°
22	Volts Ave.	✓	✓	✗	10 - 120 %	Vnom ⁽²⁾
24	Current Ave.	✓	✓	✗	10 - 120 %	Inom
27	Watts sum	✓	✓	✗	10 - 120 %	Nom ⁽³⁾
29	VA sum	✓	✓	✗	10 - 120 %	Nom ⁽³⁾
31	VAr sum	✓	✓	✗	10 - 120 %	Nom ⁽³⁾
32	PF Ave. #	✓	✓	✗	10 - 90 %	90°
34	PA Ave. #	✓	✓	✗	10 - 90 %	360°
36	Freq. #	✓	✓	✓	10 - 90 %	66 Hz ⁽¹⁾
37	Wh Import	✓	✓	✓	10 - 9999999	Nom ⁽³⁾

TABLE 3 : Continued...

Parameter No.	Parameter	3P 4W	3P 3W	1P 2W	Trip Point Set Range	100% Value
38	Wh Export	✓	✓	✓	10 - 9999999	Nom ⁽³⁾
39	VAr Capacitive	✓	✓	✓	10 - 9999999	Nom ⁽³⁾
40	VAr Inductive	✓	✓	✓	10 - 9999999	Nom ⁽³⁾
41	VA	✓	✓	✓	10 - 9999999	Nom ⁽³⁾
43	Watt Demand Imp.*	✓	✓	✓	10 - 120 %	Nom ⁽³⁾
44	Watt Max Demand Imp.*	✓	✓	✓	10 - 120 %	Nom ⁽³⁾
45	Watt Demand Exp.*	✓	✓	✓	10 - 120 %	Nom ⁽³⁾
46	Watt Demand Max Exp.*	✓	✓	✓	10 - 120 %	Nom ⁽³⁾
47	VAr Demand Cap.*	✓	✓	✓	10 - 120 %	Nom ⁽³⁾
48	VAr Max Demand Cap.*	✓	✓	✓	10 - 120 %	Nom ⁽³⁾
49	VAr Demand Ind.*	✓	✓	✓	10 - 120 %	Nom ⁽³⁾
50	VAr Demand Max Ind.*	✓	✓	✓	10 - 120 %	Nom ⁽³⁾
51	VA Demand*	✓	✓	✓	10 - 120 %	Nom ⁽³⁾
52	VA Max Demand*	✓	✓	✓	10 - 120 %	Nom ⁽³⁾
53	Current Demand*	✓	✓	✓	10 - 120 %	Inom
54	Current Max Demand*	✓	✓	✓	10 - 120 %	Inom
101	VL1-L2	✓	✗	✗	10 - 120 %	Vnom (L-L)
102	VL2-L3	✓	✗	✗	10 - 120 %	Vnom (L-L)
103	VL3-L1	✓	✗	✗	10 - 120 %	Vnom (L-L)
113	I Neutral	✓	✗	✗	10 - 120 %	Inom
114	Relay Manual OFF	✓	✓	✓	1	-
115	Relay Manual ON	✓	✓	✓	1	-

Note : Parameters 1,2,3 are L-N Voltage for 3P 4W & L-L Voltage for 3P 3W.

***Note : Parameters marked are not applicable for the Basic version of ND25.**

#Note : Refer #Note of Section 5.2 for details.

- (1) For Frequency 0% corresponds to 45 Hz and 100% corresponds to 66 Hz.
- (2) For 3P 4W and 1P2W the nominal value is VLN and that for 3P 3W is VLL.
- (3) Nominal Value for power is calculated from Nominal Voltage and current values.
- (4) Nominal Value is to be considered with set CT/ PT Primary values.
- (5) For single phase L1 Phase values are to be considered as System values.

5.3 Timer Output

Timer output can be used to operate the Relay in a cyclic manner. The user can define the ON period and OFF period and also the number of times this cycle is to be repeated. The number of Cycles (N) can be indefinite or 1 to 9999. The counting is shown on a measurement screen as explained before.

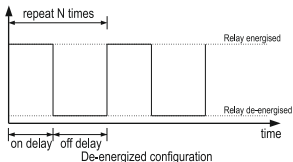
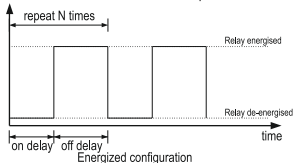

TABLE 5 : Datalogging Parameters List

Para. No.	Parameter	3P 4W	3P 3W	1P 2W
0	V1	✓	✓	✓
1	V2	✓	✓	✗
2	V3	✓	✓	✗
3	I1	✓	✓	✓
4	I2	✓	✓	✗
5	I3	✓	✓	✗
6	W1	✓	✗	✓
7	W2	✓	✗	✗
8	W3	✓	✗	✗
9	VA1	✓	✗	✓
10	VA2	✓	✗	✗
11	VA3	✓	✗	✗
12	VAR1	✓	✗	✓
13	VAR2	✓	✗	✗
14	VAR3	✓	✗	✗
15	PF1	✓	✗	✓
16	PF2	✓	✗	✗

TABLE 5: Continued...

Para. No.	Parameter	3P 4W	3P 3W	1P 2W
17	PF3	✓	✗	✗
18	Angle1	✓	✗	✓
19	Angle2	✓	✗	✗
20	Angle3	✓	✗	✗
21	Volt Avg	✓	✓	✗
22	Volt Sum	✓	✓	✗
23	Current Avg	✓	✓	✗
24	Current Sum	✓	✓	✗
25	Watt Avg	✓	✓	✗
26	Watt Sum	✓	✓	✗
27	VA Avg	✓	✓	✗
28	VA Sum	✓	✓	✗
29	VAR Avg	✓	✓	✗
30	VAR Sum	✓	✓	✗
31	PF Avg	✓	✓	✗
32	PF Sum	✓	✗	✗
33	Phase Angle Avg	✓	✓	✗
34	Phase Angle Sum	✓	✓	✗
35	Freq	✓	✓	✓
36	Wh import	✓	✓	✓
37	Wh export	✓	✓	✓
38	VARh Capacitive	✓	✓	✓
39	VARh Inductive	✓	✓	✓
40	VAh	✓	✓	✓
42	kw imp demand	✓	✓	✓
43	max kW imp demand	✓	✓	✓
44	kW exp demand	✓	✓	✓
45	max kW exp demand	✓	✓	✓
46	kVAr Cap. demand	✓	✓	✓

TABLE 5: Continued...

Para. No.	Parameter	3P 4W	3P 3W	1P 2W
47	max kVAr Cap. demand	✓	✓	✓
48	kVAr Ind. demand	✓	✓	✓
49	max kVAr Ind. demand	✓	✓	✓
50	KVA demand	✓	✓	✓
51	max KVA demand	✓	✓	✓
52	current demand	✓	✓	✓
53	max current demand	✓	✓	✓
54	Wh Import Overflow Count	✓	✓	✓
56	Wh Export Overflow Count	✓	✓	✓
58	VARh Capacitive OF Count	✓	✓	✓
60	VARh Inductive OF Count	✓	✓	✓
62	Vah Overflow Count	✓	✓	✓
66	system voltage max	✓	✓	✓
67	system voltage min	✓	✓	✓
68	RPM	✓	✓	✓
70	system current max	✓	✓	✓
71	system current min	✓	✓	✓
100	V12	✓	✗	✗
101	V23	✓	✗	✗
102	V31	✓	✗	✗
103	V THD-L1	✓	✓	✓
104	V THD-L2	✓	✓	✗
105	V THD-L3	✓	✓	✗
106	I THD-L1	✓	✓	✓
107	I THD-L2	✓	✓	✗
108	I THD-L3	✓	✓	✗
109	System V-THD	✓	✓	✓
110	System I-THD	✓	✓	✓
112	Neutral Current	✓	✗	✗

TABLE 5: Continued...

Para. No.	Parameter			
		3P 4W	3P 3W	1P 2W
113	Run hour	✓	✓	✓
114	On Hour	✓	✓	✓
115	No. of interrupts	✓	✓	✓
166	Phase indicate	✓	✓	✗

6. Phasor Diagram :

Quadrant 1: 0° to 90°

Quadrant 2: 90° to 180°

Quadrant 3: 180° to 270°

Quadrant 4: 270° to 360°

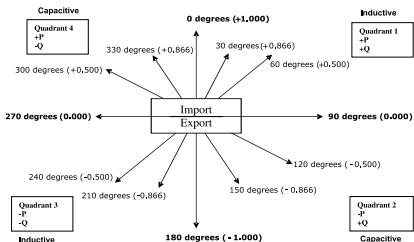

Connections	Quadrant	Sign of Active Power (P)	Sign of Reactive Power (Q)	Sign of Power Factor (PF)	Inductive / Capacitive
Import	1	+ P	+ Q	+	L
Import	4	+ P	- Q	+	C
Export	2	- P	+ Q	-	C
Export	3	- P	- Q	-	L

Inductive means Current lags Voltage

Capacitive means Current leads Voltage

When Multifunction Meter displays Active power (P) with " + " (positive sign), the connection is "**Import**".

When Multifunction Meter displays Active power (P) with " - " (negative sign), the connection is "**Export**".

7. Installation

Mounting of the Meter is featured with easy "Clip-in" mounting. Push the meter in panel slot (size 92 x92 mm), it will click fit into panel with the four integral retention clips on two sides of meter. If required, additional support is provided with swivel screws as shown in figure.

The front of the enclosure conforms to IP54. Additional protection to the panel may be obtained by the use of an Optional panel gasket. The terminals at the rear of the product should be protected from liquids.

The Meter should be mounted in a reasonably stable ambient temperature and where the operating temperature is within the range 0 to 50°C. Vibration should be kept to a minimum and the product should not be mounted where it will be subjected to excessive direct sunlight.

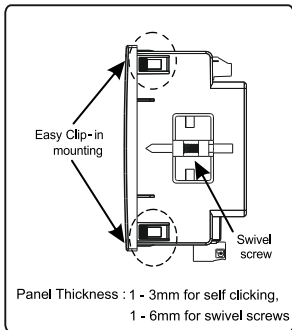

Caution

1. In the interest of safety and functionality this product must be installed by a qualified engineer, abiding by any local regulations.
2. Voltages dangerous to human life are present at some of the terminal connections of this unit. Ensure that all supplies are de-energised before attempting any connection or disconnection.
3. These products do not have internal fuses therefore external fuses must be used to ensure safety under fault conditions.

7.1 EMC Installation Requirements

This product has been designed to meet the certification of the EU directives when installed to a good code of practice for EMC in industrial environments, e.g.

1. Screened output and low signal input leads or have provision for fitting RF suppression components, such as ferrite absorbers, line filters etc., in the event that RF fields cause problems.

Note : It is good practice to install sensitive electronic instruments that are performing critical functions, in EMC enclosures that protect against electrical interference which could cause a disturbance in function.

2. Avoid routing leads alongside cables and products that are, or could be, a source of interference.

3. To protect the product against permanent damage, surge transients must be limited to 2kV pk. It is good EMC practice to suppress differential surges to 2kV at the source. The unit has been designed to automatically recover in the event of a high level of transients. In extreme circumstances it may be necessary to temporarily disconnect the auxiliary supply for a period of greater than 5 seconds to restore correct operation.

The Current inputs of these products are designed for connection in to systems via Current Transformers only, where one side is grounded.

4. ESD precautions must be taken at all times when handling this product.

7.2 Case Dimensions and Panel Cut-Out

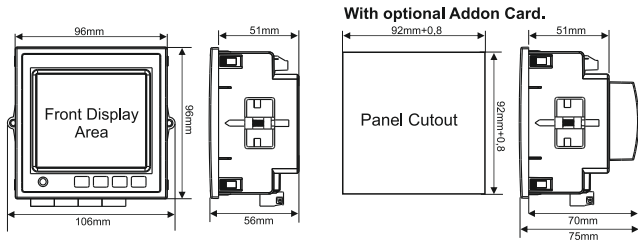

7.3 Wiring

Input connections are made directly to screw-type terminals with indirect wire pressure. Numbering is clearly marked on the connector. Choice of cable should meet local regulations. Terminal for both Current and Voltage inputs will accept upto 4mm²(12AWG) solid or 2.5 mm² stranded cable.

Note: It is recommended to use **wire with lug** for **connection with meter**.

7.4 Auxiliary Supply

Meter should ideally be powered from a dedicated supply, however powered from the signal source, provided the source remains within it may be the limits of the Chosen auxiliary voltage range.

7.5 Fusing

It is recommended that all voltage lines are fitted with 1 Amp HRC fuse.

7.6 Earth/Ground Connections

For safety reasons, CT secondary connections should be grounded in accordance with local regulations.

8. Connection Diagrams

3-PHASE 3-WIRE UNBALANCED LOAD
DIGITAL METERING SYSTEM (WITH EXTERNAL AUX.)

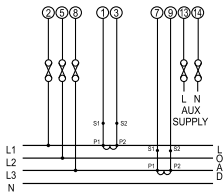

3-PHASE 4-WIRE UNBALANCED LOAD
DIGITAL METERING SYSTEM (WITH EXTERNAL AUX.)

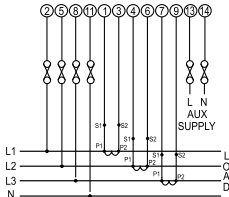

SINGLE PHASE 2-WIRE
DIGITAL METERING SYSTEM (WITH EXTERNAL AUX.)

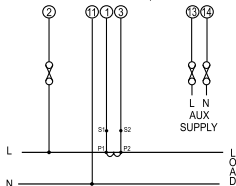

9. Pluggable Module

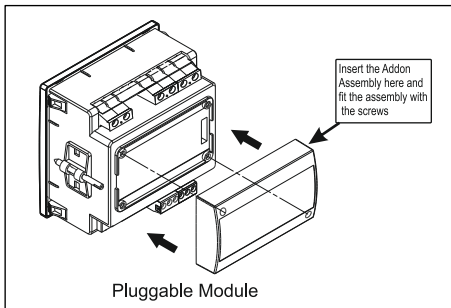

Auxiliary Supply

External Higher Aux.	100V to 550V AC-DC
External Higher Aux. Nominal Value	230V AC/DC 50/60 Hz for AC Aux
Aux Frequency Range	45 to 65 Hz
VA Burden With Addon card	< 6 VA approx. (at nominal)
VA Burden With Ethernet card	< 8 VA approx. (at nominal)

Operating Measuring Ranges

Voltage	20 ... 120 % of nominal Value
Current	1....120% of nominal value

Starting Current

as per IEC 62053-22 (0.5s/0.2s)

Frequency	45 to 66 Hz
Power Factor	0.5 Lag ... 1 ... 0.8 Lead
Total Harmonic Distortion	50% upto 15th harmonic 10% upto 31st harmonic

Reference conditions for Accuracy

Reference temperature (as per IEC 62053-21)	$23^{\circ}\text{C} \pm 2^{\circ}\text{C}$
--	--

Accuracy

Voltage	$\pm 0.5\%$ of nominal value
Current	$\pm 0.5\%$ of nominal value
Frequency	$\pm 0.2\%$ of mid frequency
Active power	$\pm 0.5\%$ of nominal value
Reactive power	$\pm 1.0\%$ of nominal value

10. Specification

System

3 Phase 3 Wire / 4 Wire or Single Phase programmable on site

Inputs

Nominal Input Voltage (AC RMS)	100VLL to 600VLL programmable on site. (57.7VLN to 346.4VLN)
System PT Primary Values	100VLL to 1200 kVLL, programmable on site
System PT Secondary Values	100VLL to 600VLL programmable on site. (57.7VLN to 346.4VLN)
Max continuous input voltage	120% of Nominal Value
Nominal input voltage burden	<0.3 VA approx. per Phase (at nominal 240V)
Nominal Input Current	1A/5A
max continuous input current	120% of Nominal value
Nominal input current burden	<0.3 VA approx. per phase
System CT primary values	Std. Values 1 to 9999A (1 or 5 Amp secondary)
System CT secondary values	1A / 5A, programmable on site
Overload Indication	"-OL-" >121% of Nominal value (for voltage and current)
Overload withstand	
Voltage input	2 x Rated Value (1s application at 10s intervals) repeated 10 times
Current input	2 x nominal Value (1s application at 5min intervals) repeated 5 times

Apparent Power	$\pm 0.5\%$ of nominal value
Power Factor / Phase Angle	$\pm 3^\circ$
Active energy	as per IEC 62053-22 (0.5s) as per IEC 62053-22 (0.2s) (optional)
Reactive energy	Class 2 as per IEC 62053-23
Apparent energy	class 1
THD (Voltage / Current)	$\pm 3.0\%$

Accuracy (for optional 0.2s)

Voltage	$\pm 0.2\%$ of nominal value
Current	$\pm 0.2\%$ of nominal value
Frequency	$\pm 0.2\%$ of mid frequency
Active power	$\pm 0.2\%$ of nominal value
Apparent Power	$\pm 0.2\%$ of nominal value

Display

LCD Display with backlit	
Response time to step input	Approx. 1 sec.

Controls

User Interface	3 push buttons
----------------	----------------

Standards

EMC Immunity	IEC 61326 - 1 : 2012
Immunity	IEC 61000-4-3, 10V/m - Level 3 industrial Low level
Safety	IEC 61010-1-2010, permanently connected use
IP for water & dust	IEC 60529

Pollution degree	2
Installation Category	III

Isolation

Protective Class	2
High Voltage Test	
Input+Aux vs Surface	4 kV RMS, 50Hz, 1 min
Input vs Remaining Circuit	3.3 kV RMS, 50Hz, 1 min

Environmental conditions

Operating temperature	-10 to +60 °C
Storage temperature	-20 to +70 °C
Relative humidity	0 .. 95 % RH (Non condensing)
Warm up time	3 minute (minimum)
Shock (As per IEC 60068-2-27)	Half Sine wave, Peak acceleration 30gn (300 m/s ²), duration 18 ms
Vibration	10..150..10 Hz, 0.15mm amplitude
Number of Sweep cycles	10 per axis

Enclosure

Enclosure front	IP 54
Enclosure back (Terminals)	IP 20

Dimensions

Bezel Size	96mm x 96mm DIN 43718
Panel cut out	92mm+0.8 X 92mm+0.8
Overall Depth	75 mm
Panel thickness	1 - 3mm for self clicking 1 - 6mm for swivel screws
Weight	320 grams Approx.

Pulse output Option

Relay	1NO
Switching Voltage & Current	240 VAC , 5 A.
Default Pulse rate Divisor	1 per Wh (up to 3600W), 1 per kWh (up to 3600kW), 1 per MWh (above 3600 kW up to 30000 kW)
Pulse rate Divisors	Programmable on site
10	1 per 10Wh (up to 3600W), 1 per 10kWh (up to 3600kW), 1 per 10MWh (above 3600 kW up to 30000 kW)
100	1 per 100Wh (up to 3600W), 1 per 100kWh (up to 3600 kW), 1 per 100MWh (above 3600 kW up to 30000 kW)
1000	1 per 1000Wh (up to 3600W), 1 per 1000kWh (up to 3600kW), 1 per 1000MWh (above 3600 kW up to 30000 kW)
Pulse Duration	60ms , 100ms or 200ms

Note :

1. Refer TABLE 4 for details.

2. Above conditions are also applicable for Reactive & Apparent Energy.

ModBus (RS 485) Option :

Protocol	ModBus (RS 485)
Baud Rate	4.8k, 9.6k, 19.2k, 38.4k, 57.6kbps
Parity	Odd or Even, with 1 stop bit, Or None with 1 or 2 stop bits

Ethernet

Ethernet access on Modbus TCP/IP Protocol

Impulse Output :

Impulse LED For Energy testing

Impulse Constant

Depending on nominal system nominal power, the number of impulses are created to measure the energy. The number of impulses for particular nominal power is set which indicates 1kWh energy. Energy can be Watt, VA or Var. Following table shows impulses corresponding to nominal system energy.

System nominal power	Impulse constant
<=400	16000
<=800	8000
<=1600	4000
<=3200	2000
>3200	1000

11. Connection for Optional Pulse Output / RS 485 (rear view of Multifunction Meter):

1. RS 485 Output with Relay1 & Relay2

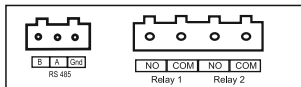

12. Ordering codes

Model	Key features
END25RSA	RS485 interface + 2 Pulses outputs, accuracy class 0.5s
END25ETHA	Ethernet + data logging, accuracy class 0.2s



ETI Elektroelement d.o.o.
1411 Izlake
Slovenia

Tel. : +386 03 56 57 570
e-mail: eti@eti.si

3.2.5. Вибір параметра вихідних контактів



Цей екран дозволить користувачеві встановити параметри релейних вихідних контактів. Натискання кнопки «■» дозволяє користувачеві вибрати і налаштувати параметри вихідних контактів (Розділ 3.2.5.1)**.

Натискання кнопки «▲» призведе до переходу на екран «Вибір параметра журналу даних» (Розділ 3.2.6)**, а натискання кнопки «▼» - до екрану «Вибір параметра скидання» (Розділ 3.2.4)**.

3.2.6. Вибір параметра журналу даних



Цей екран дозволить користувачеві вибрати такі параметри журналу даних, як «За подією», «За часом» і «Профіль навантаження».

Натискання кнопки «■» дозволяє користувачеві вибрати і налаштувати параметри журналу даних (Розділ 3.2.6.1)**.

Натискання кнопки «▲» призведе до переходу на екран «Параметри екрану» (Розділ 3.2.7)**, а натискання «▼» - до екрану «Вибір параметра вихідних контактів» (Розділ 3.2.5)**.

3.2.7. Параметри екрану



Цей екран дозволить користувачеві отримати доступ до різних функцій, таких як «Підсвічування», «Екрани користувача», «Контрастність» і «Додаткові параметри».

Натискання кнопки «■» дозволяє користувачеві вибрати і налаштувати параметри екрану (Розділ 3.2.7.1)**.

Натискання кнопки «▲» призведе до переходу на екран «Налаштування годинника реального часу» (Розділ 3.2.8)**, а натискання кнопки «▼» - до екрану «Вибір параметра журналу даних» (Розділ 3.2.6)**.

3.2.8. Налаштування годинника реального часу



Цей екран дозволить користувачеві отримати доступ до таких функцій, як «Встановити дату» та «Встановити час».

Натискання кнопки «■» дозволяє користувачеві вибрати дату і час (Розділ 3.2.8.1)**.

Натискання кнопки «▲» призведе до переходу на екран «Скидання до заводських налаштувань» (Розділ 3.2.9)**, а натискання кнопки «▼» - до екрану «Параметри екрану» (Розділ 3.2.7)**.

3.2.9. Скидання до заводських налаштувань



Цей екран дозволяє користувачеві скинути аналізатор до заводських налаштувань (Розділ 3.2.9.1)**.

Натискання кнопки «▲» призведе до переходу на екран «Вихід з меню» (Розділ 3.2.10)**, а натискання кнопки «▼» - до екрану «Налаштування годинника реального часу» (Розділ 3.2.8)**.

3.2.10. Вихід з меню



Цей екран дозволить користувачеві вийти з меню налаштувань (Розділ 3.2.10.1)**

Натискання кнопки «■» дозволяє користувачеві вийти з меню налаштувань і повернутись до екрану вимірювань.

Натискання кнопки «▲» призведе до переходу на екран «Вибір системного параметра» (Розділ 3.2.1)**, а натискання кнопки «▼» - до екрану «Скидання до заводських налаштувань» (Розділ 3.2.9)**.

** - див. повну версію інструкції користувача.

4. МОНТАЖ

Прилад монтується за допомогою утримуючих затискачів. Вставте аналізатор в монтажний отвір розміром 92 x 92 мм та зафіксуйте його за допомогою чотирьох затискачів, що розміщені з двох боків приладу. При необхідності можна використовувати два додаткові гвинтові тримачі, як показано на рисунку.

Передня частина корпусу має ступінь захисту IP54. Додатковий захист панелі можна отримати, використовуючи додаткову прокладку для отвору на панелі. Клеми на задній частині приладу повинні бути захищені від контакту з рідинами.

Аналізатор повинен працювати за відносно стабільної температури навколишнього середовища в діапазоні від -10° до 55°C. Вібращі повинні бути зведені до мінімуму і прилад не слід встановлювати в місцях з прямими сонячними променями.

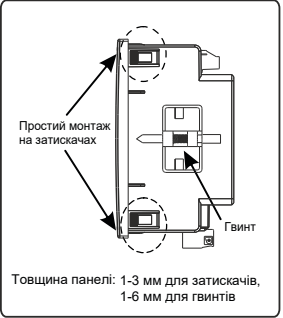

Увага!
1. В інтересах безпеки і функціональності цей прилад повинен бути встановлений кваліфікованим персоналом з дотриманням всіх місцевих норм техніки безпеки.
2. На клеммах даного приладу присутня небезпечна для життя напруга. Перед спробою підключення або відключення переконайтеся, що всі джерела живлення знеструмлені.
3. Прилад не має внутрішніх запобіжників. Для захисту приладу від пошкоджень, викликаних надмірним струмом, слід використовувати зовнішні запобіжники.

4.1. Вимоги EMC

Цей прилад був розроблений відповідно з сертифікацією директив ЄС щодо електромагнітної сумісності для приладів, що працюють у промисловому середовищі:
1. Екрановані вихідні і вхідні кабелі з низьким рівнем сигналу або передбачені засоби для встановлення компонентів зменшення радіочастот, таких як феритові сердечники, мережеві фільтри і т. д., у випадку виникнення проблем з радіочастотними полями.
Примітка: рекомендується встановлювати чутливі електронні прилади, які виконують критично важливі функції, в корпусах з електромагнітною сумісністю, які мають захист від електромагнітних перешкод, що можуть викликати порушення роботи.

2. Уникайте прокладання вимірювальних кабелів поруч з кабелями і виробами, які є або можуть бути джерелами перешкод.

3. Щоби захистити прилад від незворотного пошкодження, імпульсні пікові перенапруги повинні бути обмежені до 2 кВ. Гарною практикою EMC є зменшення стрибків напруги до 2 кВ в джерелі. Прилад був розроблений з автоматичним відновлення в разі високого рівня перехідних процесів. Однак у разі надзвичайно високих перенапруг може знадобитися тимчасове відключення джерела живлення на період більше 5 секунд для відновлення належного функціонування.

Трансформатори струму, що використовуються з аналізатором, повинні мати заземлення вторинної обмотки.

4. При використанні цього приладу необхідно завжди дотримуватися запобіжних заходів захисту від електростатичного розряду.

4.2. Розміри корпусу і виріз на панелі

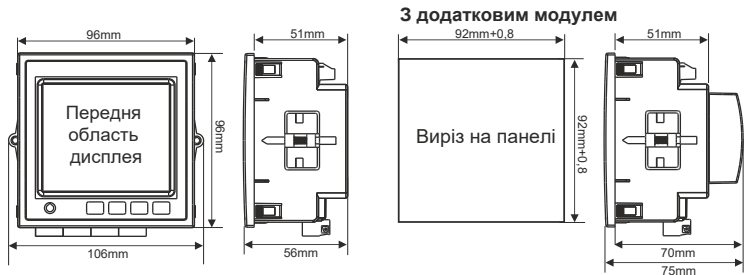

4.3. Підключення провідників

З'єднання вхідних контактів виконуються безпосередньо на гвинтових клемах з непрямым тиском на провід. Нумерація чітко позначена на клемі. Вибір кабелю повинен відповідати місцевим нормам. Для вхідних клем струму і напруги дозволено використовувати одножильний кабель перерізом до 4 мм² (12AWG) або багатожильний кабель перерізом до 2,5 мм².

Примітка: рекомендується використовувати кабель з наконечником.

4.4. Живлення приладу

Прилад повинен живитися від окремого джерела енергії, однак можна забезпечити живлення від вимірювальної мережі, за умови, що напруга перебуває в діапазоні, допустимому для застосування в якості джерела живлення.

4.5. Запобіжники

Рекомендується, щоб усі лінії напруги були захищені запобіжниками з високою вимикальною здатністю з номіналом в 1 ампер.

4.6. Заземлення

Для забезпечення безпеки вторинні обмотки трансформаторів струму повинні бути заземлені відповідно до вимог монтажу.

5. СХЕМИ ПІДКЛЮЧЕННЯ

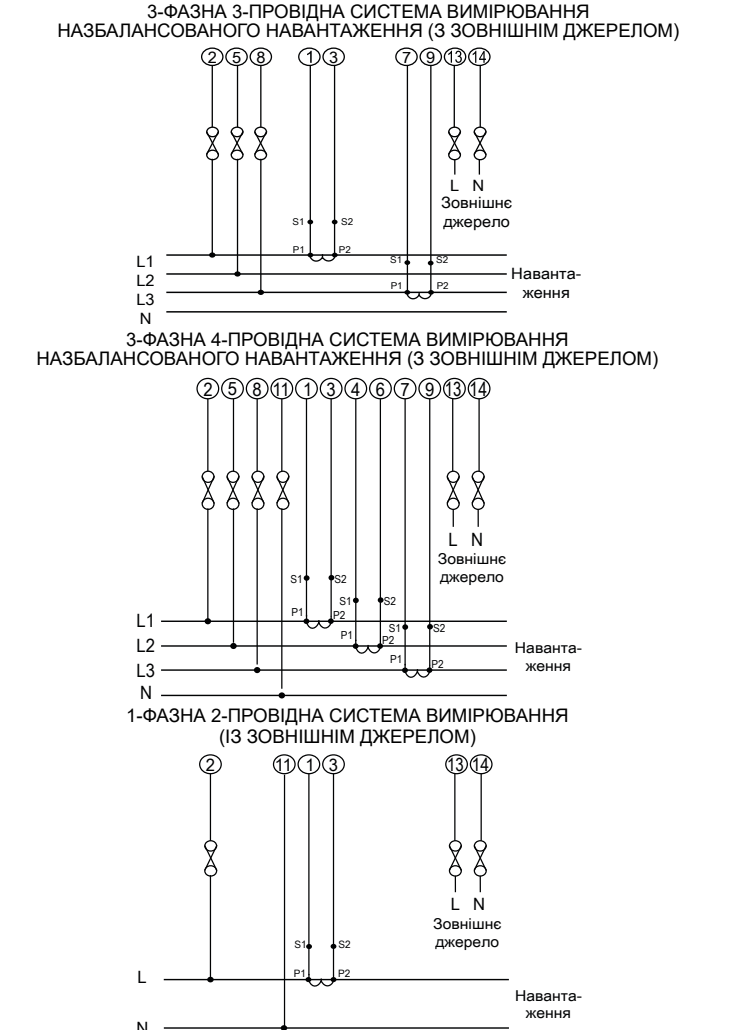

6. ДОДАТКОВИЙ МОДУЛЬ

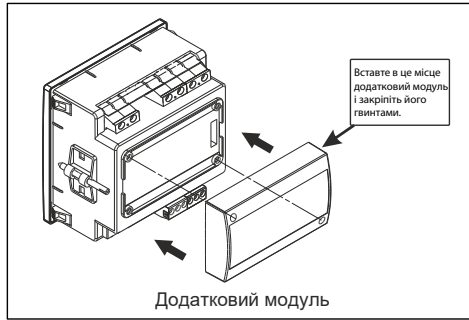

7. ТЕХНІЧНІ ХАРАКТЕРИСТИКИ

Мережа	3-фазна 3- або 4-провідна, 1-фазна програмується безпосередньо на об'єкті
Вимірювання	
Номинальна вхідна напруга (AC, середньоквадратична)	Лінійна напруга 100V - 600 V L-L Фазна напруга 57,7V - 346,4 V L-N програмується безпосередньо на об'єкті
Напруга первинної обмотки ТН	Від 100V L-L до 1200 kV L-L програмується безпосередньо на об'єкті
Напруга вторинної обмотки ТН	Від 100V L-L до 600 V L-L програмується безпосередньо на об'єкті
Максимальна тривала вхідна напруга	120% від номінального значення
Номинальне вхідне навантаження по напрузі	<0,3 ВА на фазу (при номінальній U - 240 V)
Номинальний вхідний струм	1A/5A AC
Максимальний тривалий вхідний струм	120% від номінального значення
Номинальне вхідне навантаження по струму	<0,3 А на фазу
Струм первинної обмотки ТС	Від 1А до 9999А програмується безпосередньо на об'єкті
Струм вторинної обмотки ТС	1А/5А програмується безпосередньо на об'єкті
Індикація перевантаження	"_OL_" >121% від номінального значення (для напруги та струму)
Витримуване перевантаження	
Вхід по напрузі	2 x номінального значення (1-секундний повтор 10 разів з 10-секундним інтервалом)
Вхід по струму	2 x номінального значення (1-секундний повтор 5 разів з 5-секундним інтервалом)
Зовнішнє джерело живлення	
Діапазон напруги джерела живлення	100V - 550V AC/DC
Номинальна напруга джерела живлення	230V AC/DC 50 Hz
Частота джерела живлення	45 - 65 Hz
Навантаження по напрузі з додатковим модулем	<6 VA (за номіналом)
Навантаження по напрузі з модулем Ethernet	<8 VA (за номіналом)
Робочі діапазони вимірювань	
Напруга	20 ... 120 % від номінального значення
Струм	1 ... 120 % від номінального значення
Пусковий струм	згідно IEC 62053-22 (0,5 c / 0,2 c)
Частота	45 - 66 Hz
Коефіцієнт потужності	0,5 індуктивний ... 1 ... 0,8 ємнісний
Загальна гармонійне спотворення	50% до 15-ї гармоніки 10% до 31-ї гармоніки
Точність вимірювання забезпечується при	
Температура (згідно IEC 62053-21)	23°C ± 2°C
Точність вимірювання	
Напруга	±0,5 % від номінального значення
Струм	±0,5 % від номінального значення
Частота	±0,2 % від середнього значення
Активна потужність	±0,5 % від номінального значення
Реактивна потужність	±1,0 % від номінального значення
Повна потужність	±0,5 % від номінального значення
Коефіцієнт потужності / Кут зсуву фаз	±3°
Активна енергія	згідно IEC 62053-22 (0,5 c) згідно IEC 62053-22 (0,2 c) (опціонально)
Реактивна енергія	Клас 2 згідно IEC 62053-23
Повна енергія	Клас 1
THD (Напруга / Струм)	±3,0 %
Точність вимірювання (для опціональних 0,2 c)	
Напруга	±0,2 % від номінального значення
Струм	±0,2 % від номінального значення
Частота	±0,2 % від середнього значення
Активна потужність	±0,2 % від номінального значення
Повна потужність	±0,2 % від номінального значення
Екран	
РК-дисплей з підсвічуванням	
Час відгуку на введення	Приблизно 1 секунда
Управління	
Інтерфейс користувача	3 кнопки
Відповідність стандартам	
EMC	IEC 61326 - 1 : 2012 IEC 61000-4-3. 10V/m min – Рівень 3 Промисловий низький рівень
Стийкість	IEC 61010-1-2010, використовується постійне підключення
Безпека	IEC 61010-1-2010, використовується постійне підключення
Ступінь захисту IP	IEC 60529

Ступінь забруднення	2
Категорія перенапруги	III
Ізоляція	
Клас захисту	2
Випробування високою напругою	
Вхідні клеми+клеми живлення до поверхні	4 kV середнє значення, 50 Hz, 1 хв
Вхідні клеми до інших клем	3,3 kV середнє значення, 50 Hz, 1 хв
Параметри навколишнього середовища	
Робочий діапазон температур	Від -10 до +60°C
Температура зберігання	Від -20 до +70°C
Відносна вологість	0 ... 90% (без утворення конденсату)
Час нагріву приладу	Мінімум 3 хвилини
Ударний імпульс (згідно IEC 60068-2-27)	Напівхвиля синусоїди, пікове прискорення 30 gn (300 м/с²), тривалість - 18 мс 10... 150.... 10 Hz, амплітуда 0,15 мм
Вібрація	
Кількість циклів розгортки	10 на вісь
Параметри корпусу	
Передня частина	IP54
Задня частина (клеми)	IP20
Розміри	
Розмір передньої частини	96 мм x 96 мм DIN 43718
Виріз в панелі	92 мм+0,8 x 92 мм+0,8
Загальна глибина	75 мм
Товщина панелі	1 - 3 мм для затискачів 1 - 6 мм для гвинтів
Маса	320 грам
Параметри імпульсних вихідних контактів	
Тип контакту	1 NO
Потужність комутації	5 А, 240 V AC
Дільник частоти імпульсів за замовчуванням	1 на Втгод (до 3600 Вт)
	1 на кВтгод (до 3600кВт) 1 на МВтгод (від 3600 кВт до 30000 кВт)
Дільник частоти імпульсів 10	1 на 10 Втгод (до 3600 Вт) 1 на 10 кВтгод (до 3600кВт) 1 на 10 МВтгод (від 3600 кВт до 30000 кВт)
100	1 на 100 Втгод (до 3600 Вт) 1 на 100 кВтгод (до 3600кВт) 1 на 100 МВтгод (від 3600 кВт до 30000 кВт)
1000	1 на 1000 Втгод (до 3600 Вт) 1 на 1000 кВтгод (до 3600кВт) 1 на 1000 МВтгод (від 3600 кВт до 30000 кВт)
Тривалість імпульсу	60 мс, 100 мс або 200 мс

Примітка:
1. Більш докладну інформацію див. в таблиці 4 **.
2. Вищевказані умови також відносяться для реактивної і повної енергії.

Параметри ModBus (RS 485)	
Протокол	ModBus (RS485)
Швидкість передачі	4.8к, 9.6к, 19.2к, 38.4к, 57.6kbps
Парність	Непарний або парний з 1 стоповим бітом або "None" з 1 або 2 стоповими бітами
Ethernet	Доступ до Ethernet по протоколу Modbus TCP/IP
Імпульсний вихід	
Імпульсний світлодіод	Для тестування

8. ПІДКЛЮЧЕННЯ ДОДАТКОВОГО ІМПУЛЬСНОГО ВИХОДУ / RS485 (вид аналізатора ззаду)

Вихідні контакти та контакти RS485

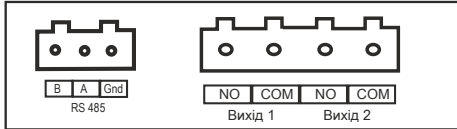

Модель	Особливість
END25RSA	Інтерфейс RS485 + 2 імпульсних групи контактів, клас точності 0,5s
END25ETHA	Ethernet + реєстрація даних, клас точності 0,2s

Повна версія і інструкція користувача різними мовами доступні на сайті www.etigroup.eu і по QR-коду



ETI Elektroelement d.o.o.
1411 Izlake
Slovenia

Tel. : +386 03 56 57 570
e-mail: eti@eti.si



POWER NETWORK METER END25

USER'S MANUAL

1. INTRODUCTION

The Multifunction Instrument is a panel mounted 96 x 96mm DIN Quadratic Digital Panel Meter, which measures important electrical parameters in 3 ph 4 wire / 3 wire / 1ph Network and replaces the multiple analog panel meters. It measures electrical parameters like AC voltage, Current, Frequency, Power, Energy (Active / Reactive / Apparent), phase angle, power factor, individual harmonics & many more. The instrument integrates accurate measurement technology (All Voltages & current measurements are True RMS upto 31st Harmonic) with LCD display with backlight.

It can be configured & Programmed at site for the following : PT Primary, PT Secondary, CT Primary, CT Secondary 3 Phase 3W, 3 Phase 4W, 1 Phase 2W system.

The front panel has three push buttons using which the user can scroll through different screens & configure the product. The front panel also has Impulse red led, flashing at rate proportional to measured power.

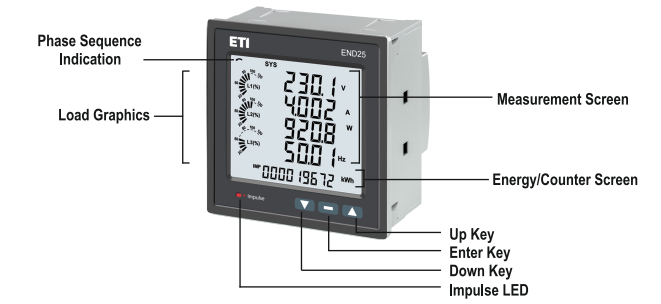

2. MEASUREMENT AND ENERGY/COUNTER SCREENS

In normal operation, the user is presented with two simultaneous screens:

1. One of the **Measurement screens** out of the screens 1 to 36 of Table .
2. One of the **Energy/Counter screens** out of the screens 37 to 62 of Table 1.

These screens may be scrolled through one at a time in incremental order only by pressing the "Enter key" to roll over again in the same order. Few important screens are explained in Section 2.7 to 2.9**.

Load Graphics
Load Graphics indicates the input current as the percentage of the CT Primary value. This indication is available for all measurement screens. For example, consider CT Primary to be set at 5A, then the input current of 2.5 A indicates 50% as shown below.

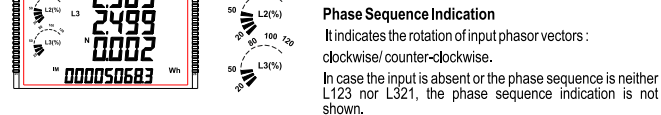

Phase Sequence Indication
It indicates the rotation of input phasor vectors : clockwise/ counter-clockwise.
In case the input is absent or the phase sequence is neither L123 nor L321, the phase sequence indication is not shown.



UP KEY
ENTER KEY
DOWN KEY

TABLE 1 : Measurement & Energy/Counter Screens for Advanced version of END25

Screen No.	Parameters	On Display			On Modbus		
		3P 4W	3P 3W	1P 2W	3P 4W	3P 3W	1P 2W
1	System Voltage/ Current/ Power/ Frequency	✓	✓	✓	✓	✓	✓
2	L-N Voltage	✓	✓	✓	✓	✓	✓
3	L-L Voltage	✓	✓	✓	✓	✓	✓
4	Current /Neutral Current	✓	✓	✓	✓	✓	✓
5	Phase Voltage THD	✓	✓	✓	✓	✓	✓
6	Phase Current THD	✓	✓	✓	✓	✓	✓
7	L1 phase VA/Var/W/PF	✓	✓	✓	✓	✓	✓
8	L2 phase VA/Var/W/PF	✓	✓	✓	✓	✓	✓
9	L3 phase VA/Var/W/PF	✓	✓	✓	✓	✓	✓
10	Phase Angle	✓	✓	✓	✓	✓	✓
11	VA/A demand	✓	✓	✓	✓	✓	✓
12	Capacitive, Inductive VAR demand	✓	✓	✓	✓	✓	✓
13	W IMP demand	✓	✓	✓	✓	✓	✓
14	W EXP demand	✓	✓	✓	✓	✓	✓
15	Max VA/A demand	✓	✓	✓	✓	✓	✓
16	Max Capacitive, Inductive VAR demand	✓	✓	✓	✓	✓	✓
17	Max W IMP demand	✓	✓	✓	✓	✓	✓
18	Max W EXP demand	✓	✓	✓	✓	✓	✓
19	Old Max VA/A demand	✓	✓	✓	✓	✓	✓
20	Old Max Capacitive, Inductive VAR demand	✓	✓	✓	✓	✓	✓
21	Old Max W IMP demand	✓	✓	✓	✓	✓	✓
22	Old Max W EXP demand	✓	✓	✓	✓	✓	✓
23	Sys RPM/Frequency	✓	✓	✓	✓	✓	✓
24	Sys Active/Reactive/Apparent power	✓	✓	✓	✓	✓	✓
25	Sys Apparent, Reactive (Power), Phase angle, PF	✓	✓	✓	✓	✓	✓
26	Min Sys Voltage / Current	✓	✓	✓	✓	✓	✓
27	Max Sys Voltage / Current	✓	✓	✓	✓	✓	✓
28	Sys %THD Voltage /Current	✓	✓	✓	✓	✓	✓
29	Current Reversal	✓	✓	✓	✓	✓	✓
30	Phase rotation error	✓	✓	✓	✓	✓	✓
31	Phase absent indication	✓	✓	✓	✓	✓	✓
32	RTC	✓	✓	✓	✓	✓	✓
33	Individual harmonics V	✓	✓	✓	✓	✓	✓
34	Individual harmonics A	✓	✓	✓	✓	✓	✓
35	Timer1 No. of Cycles, ON, OFF delay	✓	✓	✓	✓	✓	✓
36	Timer2 No. of Cycles, ON, OFF delay	✓	✓	✓	✓	✓	✓
37	Active Energy Import(Overflow)	✓	✓	✓	✓	✓	✓
38	Active Energy Import	✓	✓	✓	✓	✓	✓
39	Active Energy Export(Overflow)	✓	✓	✓	✓	✓	✓
40	Active Energy Export	✓	✓	✓	✓	✓	✓
41	Reactive Capacitive energy (Overflow)	✓	✓	✓	✓	✓	✓
42	Reactive Capacitive energy	✓	✓	✓	✓	✓	✓
43	Reactive Inductive energy (Overflow)	✓	✓	✓	✓	✓	✓
44	Reactive Inductive energy	✓	✓	✓	✓	✓	✓
45	Apparent energy(Overflow)	✓	✓	✓	✓	✓	✓
46	Apparent energy	✓	✓	✓	✓	✓	✓
47	Run hour	✓	✓	✓	✓	✓	✓
48	On hour	✓	✓	✓	✓	✓	✓
49	No. of interrupts	✓	✓	✓	✓	✓	✓
50	Old Active energy Import(Overflow)	✓	✓	✓	✓	✓	✓
51	Old Active energy Import	✓	✓	✓	✓	✓	✓
52	Old Active energy Export(Overflow)	✓	✓	✓	✓	✓	✓
53	Old Active energy Export	✓	✓	✓	✓	✓	✓
54	Old Reactive Capacitive energy (Overflow)	✓	✓	✓	✓	✓	✓
55	Old Reactive Capacitive energy	✓	✓	✓	✓	✓	✓
56	Old Reactive Inductive energy (Overflow)	✓	✓	✓	✓	✓	✓
57	Old Reactive Inductive energy	✓	✓	✓	✓	✓	✓
58	Old Apparent energy(Overflow)	✓	✓	✓	✓	✓	✓
59	Old Apparent energy	✓	✓	✓	✓	✓	✓
60	Old Run hour	✓	✓	✓	✓	✓	✓
61	Old On hour	✓	✓	✓	✓	✓	✓
62	Old no. of interrupts	✓	✓	✓	✓	✓	✓

Note: (1) Only screens (with screen number) 1 to 32 are available for selectable Userscreens.
 (2) Energy on Display is Auto-Ranging For details refer Section 4.1.
 **Note: In 3P3W system, Neutral Current is not shown, only line currents are shown.
 ** - See full version of service manual.

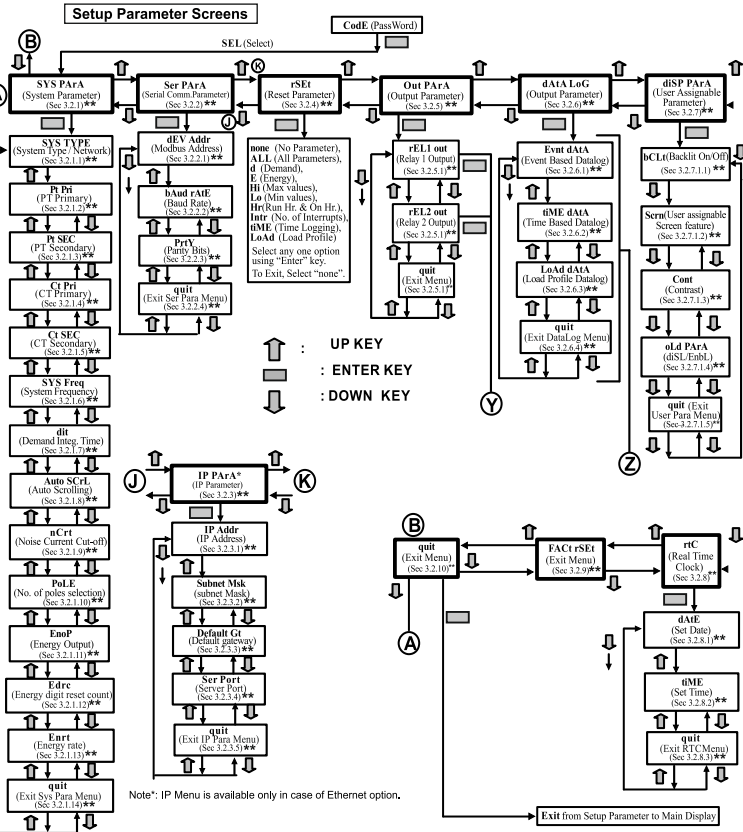

Note*: IP Menu is available only in case of Ethernet option.
 ** - See full version of service manual.

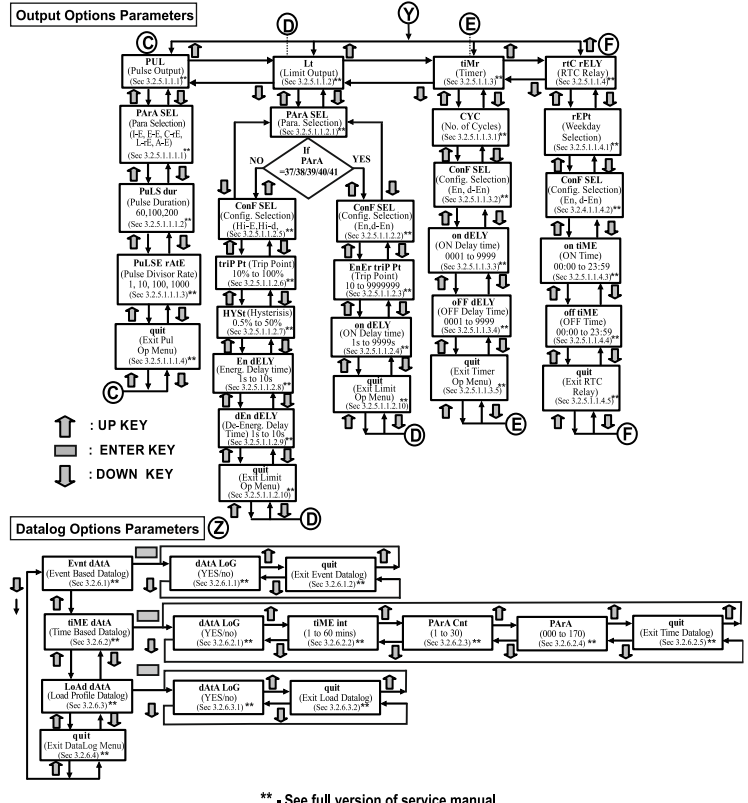

** - See full version of service manual.

3. PROGRAMMING

The following sections comprise step by step procedures for configuring the Multifunction Meter according to individual user requirements. To access the set-up screens press and hold "▲" UP" and "▼" DOWN" keys simultaneously for 5 seconds. This will take the User into the Password Protection Entry Stage (Section 3.1)**.

3.1. Password Protection

Password protection can be enabled to prevent unauthorised access to set-up screens, when default password protection is not enabled. Password protection is enabled by selecting a four digit number other than 0000, setting a password of 0000 disables the password protection.

Enter Password, prompt for first digit. Press the "▲" key to scroll the value of first digit from 0 through to 9, the value rolls back from 9 through to 0 and "▼" key to scroll the value of first digit from 9 through to 0, the value rolls back from 0 through to 9.

Press the "▬" key to advance to next digit.

In special case where the Password is "0000" pressing the "▬" key when prompted for the first digit advances to the password accepted screen and then pressing the "▬" key again makes the set-up screens accessible to the user.

But instead of pressing the "▬" key, if "▲" or "▼" key is pressed, the user is taken to the "New/change Password" entry stage.

Enter Password, first digit entered, prompt for second digit.

Press the "▲" key to scroll the value of first digit from 0 through to 9, the value rolls back from 9 through to 0 and "▼" key to scroll the value of first digit from 9 through to 0, the value rolls back from 0 through to 9.

Press the "▬" key to advance to next digit.

Enter Password, second digit entered, prompt for third digit.

Press the "▲" key to scroll the value of first digit from 0 through to 9, the value rolls back from 9 through to 0 and "▼" key to scroll the value of first digit from 9 through to 0, the value rolls back from 0 through to 9.

Press the "▬" key to advance to next digit.

Enter Password, third digit entered, prompt for fourth digit.

Press the "▲" key to scroll the value of first digit from 0 through to 9, the value rolls back from 9 through to 0 and "▼" key to scroll the value of first digit from 9 through to 0, the value rolls back from 0 through to 9.

Press the "▬" key to advance to verification of the password.

Enter Password, fourth digit entered, awaiting verification of the password.

Pressing "▲" or "▼" key advances to the "New / change Password" entry stage.

Pressing the "▬" key advances to the Menu selection (setup menu) screen (see Section 3.2).

The unit has not accepted the Password entered.

Pressing the "▲" or "▼" key advances to the Enter Password stage.

Pressing the "▬" key exits the Password menu & returns operation to the measurement reading mode.

Prompting for first digit.

Press the "▲" and "▼" keys to scroll the value of first digit from 0 through to 9 and from 9 through to 0, respectively with digit roll around feature.

Pressing the "▬" key advances the operation to the next digit and sets the first digit, in this case to '2'.

New/ Change Password, first digit entered, prompting for second digit.

Press the "▲" and "▼" keys to scroll the value of second digit from 0 through to 9 and from 9 through to 0, respectively with digit roll around feature.

Pressing the "▬" key advances the operation to the next digit and sets the second digit, in this case to '1'.

New/ Change Password, second digit entered, prompting for third digit.

Press the "▲" and "▼" keys to scroll the value of second digit from 0 through to 9 and from 9 through to 0, respectively with digit roll around feature.

Pressing the "▬" key to advance the operation to the next digit and sets the third digit, in this case to '5'.

New/ Change Password, third digit entered, prompting for fourth digit .

Press the "▲" and "▼" keys to scroll the value of second digit from 0 through to 9 and from 9 through to 0, respectively with digit roll around feature.

Pressing the "▬" key to advance the "New Password Confirmed" and sets the fourth digit, in this case to '3'.

New Password confirmed

Pressing the "▲" or "▼" key returns to the "New/Change Password" stage.

Pressing the "▬" key advances to the Menu selection screen (see Section 3.2).

3.2 Menu selection.

3.2.1 System Parameter Selection

This screen is used to select different system Parameters like "system type", "CT Ratio", "PT Ratio", etc. Pressing the "▬" key allows the user to set Different system parameters (see Section 3.2.1.1 to 3.2.1.12)**.

Pressing the "▲" key advances to the "Communication Parameter Selection" screen (see section 3.2.2) and pressing "▼" key advances to the "Quit Setup" Screen (see section 3.2.9).

3.2.2 Communication Parameter Selection

This screen is used to select the different communication parameters like "Address selection", "RS485 Parity selection", "RS485 baud rate", etc. Pressing the "▬" key allows the user to set different Communication parameters (see Section 3.2.2.1 to 3.2.2.3)**.

Pressing the "▲" key advances to the "Reset Parameter Selection" screen (if ethernet module is present then it will advance to IP parameter selection see section 3.2.3) (see section 3.2.4) and pressing "▼" key advances to the "System Parameter Selection" screen (see Section 3.2.1).

3.2.3 IP Parameter Selection

This screen is used to select the different communication parameters like "IP Address selection", "Subnet mask selection", "default gateway selection", "server port selection" etc. Pressing the "▬" key allows the user to set different Ethernet parameters (see Section 3.2.3.1 to 3.2.3.5)**.

Pressing the "▲" key advances to the "Reset Parameter Selection" screen (see section 3.2.4) and pressing "▼" key advances to the "Communication Parameter Selection" screen (see Section 3.2.2).

3.2.4 Reset Parameter Selection

This screen is used to reset different parameters.

Pressing the "▬" key allows the user to reset different system parameters (see Section 3.2.4.1)**.

Pressing the "▲" key advances to the "Output Option Selection" screen (see Section 3.2.5) and pressing "▼" key advances to "Communication Parameter Selection" screen(ethernet module is present then it advances to IP parameter selection else it goes to serial communication parameter selection) (see Section 3.2.2).

** - See full version of service manual.

3.2.5 Output Option Selection



This screen will allow the user to select Output Options like "Relay Output".

Pressing the "←" key allows the user to select and configure the output options (see Section 3.2.5.1)**.

Pressing "▲" key advances to the "Datalog Option Selection" screen (see section 3.2.6) and pressing "▼" key advances to "Reset Parameter Selection" screen (see Section 3.2.4).

3.2.6 Datalog Option Selection

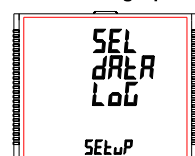

This screen will allow the user to select Datalog Options like "Event Based", "Time Based" and "Load Profile".

Pressing the "←" key allows the user to select and configure the datalog options (see section 3.2.6.1)**.

Pressing the "▲" key advances to "Display Parameters" screen (see section 3.2.7) and pressing "▼" key advances to "Output Option Selection" screen (see Section 3.2.5).

3.2.7 Display Parameters

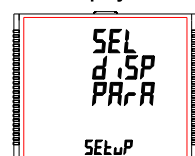

This screen will allow the user to access different features like "Backlit", "Screens", "Contrast" and "Old Parameters".

Pressing the "←" key allows the user to select and configure the features (see Section 3.2.7.1)**.

Pressing the "▲" key advances to "RTC Setting" screen (see Section 3.2.8) and pressing "▼" key advances to "Datalog Option Selection" screen (see Section 3.2.6).

3.2.8 RTC Setting

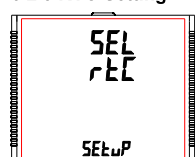

This screen will allow the user to access features like "Set Date" and "Set Time".

Pressing the "←" key allows the user to select date and time (see Section 3.2.8.1)**.

Pressing the "▲" key advances to "Factory Reset" screen (see Section 3.2.9) and pressing "▼" key advances to "Display Parameters" screen (see Section 3.2.7).

3.2.9 Factory Reset

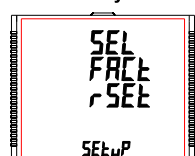

This screen allows the user to set the meter to its Factory Default settings (see Section 3.2.9.1)**.

Pressing the "▲" key advances to "Quit Setup" screen (see Section 3.2.10) and pressing "▼" key advances to "RTC Setting" screen (see Section 3.2.8).

3.2.10 Quit Setup

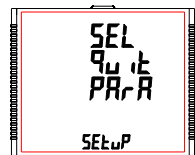

This screen will allow the user to quit the setup menu (see Section 3.2.10.1)**.

Pressing the "←" key allows the user to Quit from setup menu & return to measurement screen.

Pressing the "▲" key advances to "System Parameter Selection" screen (see Section 3.2.1) and pressing "▼" key advances to "Factory Reset" screen (see Section 3.2.9).

** - See full version of service manual.

4. Installation

Mounting of the Meter is featured with easy "Clip-in" mounting. Push the meter in panel slot (size 92 x 92 mm), it will click fit into panel with the four integral retention clips on two sides of meter. If required, additional support is provided with swivel screws as shown in figure.

The front of the enclosure conforms to IP54. Additional protection to the panel may be obtained by the use of an Optional panel gasket. The terminals at the rear of the product should be protected from liquids.

The Meter should be mounted in a reasonably stable ambient temperature and where the operating temperature is within the range 0 to 50°C. Vibration should be kept to a minimum and the product should not be mounted where it will be subjected to excessive direct sunlight.

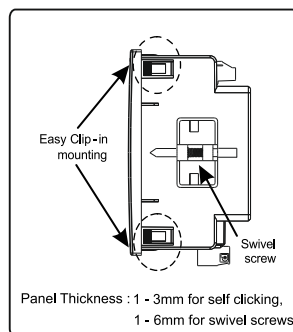

Caution

- In the interest of safety and functionality this product must be installed by a qualified engineer, abiding by any local regulations.
- Voltages dangerous to human life are present at some of the terminal connections of this unit. Ensure that all supplies are de-energised before attempting any connection or disconnection.
- These products do not have internal fuses therefore external fuses must be used to ensure safety

4.1 EMC Installation Requirements

This product has been designed to meet the certification of the EU directives when installed to a good code of practice for EMC in industrial environments, e.g.

- Screened output and low signal input leads or have provision for fitting RF suppression components, such as ferrite absorbers, line filters etc., in the event that RF fields cause problems.

Note : It is good practice to install sensitive electronic instruments that are performing critical functions, in EMC enclosures that protect against electrical interference which could cause a disturbance in function.

- Avoid routing leads alongside cables and products that are, or could be, a source of interference.
- To protect the product against permanent damage, surge transients must be limited to 2kV pk. It is good EMC practice to suppress differential surges to 2kV at the source. The unit has been designed to automatically recover in the event of a high level of transients. In extreme circumstances it may be necessary to temporarily disconnect the auxiliary supply for a period of greater than 5 seconds to restore correct operation.

The Current inputs of these products are designed for connection in to systems via Current Transformers only, where one side is grounded.

- ESD precautions must be taken at all times when handling this product.

4.2 Case Dimensions and Panel Cut-Out

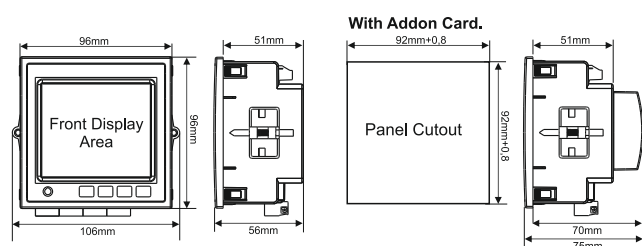

4.3 Wiring

Input connections are made directly to screw-type terminals with indirect wire pressure. Numbering is clearly marked on the connector. Choice of cable should meet local regulations. Terminal for both Current and Voltage inputs will accept upto 4mm² (12AWG) solid or 2.5 mm² stranded cable.

Note : It is recommended to use wire with lug for connection with meter.

4.4 Auxiliary Supply

Meter should ideally be powered from a dedicated supply, however powered from the signal source, provided the source remains within it may be the limits of the Chosen auxiliary voltage range.

4.5 Fusing

It is recommended that all voltage lines are fitted with 1 Amp HRC fuse.

4.6 Earth/Ground Connections

For safety reasons, CT secondary connections should be grounded in accordance with local regulations.

5. Connection Diagrams

3-PHASE 3-WIRE UNBALANCED LOAD DIGITAL METERING SYSTEM (WITH EXTERNAL AUX.)

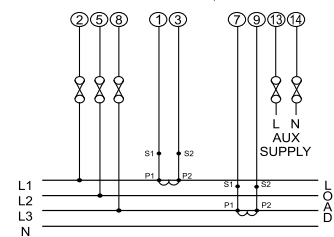

3-PHASE 4-WIRE UNBALANCED LOAD DIGITAL METERING SYSTEM (WITH EXTERNAL AUX.)

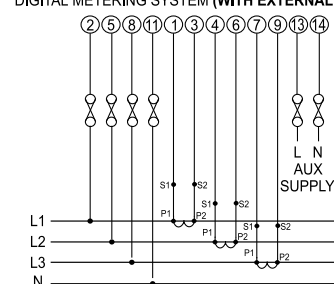

SINGLE PHASE 2-WIRE DIGITAL METERING SYSTEM (WITH EXTERNAL AUX.)

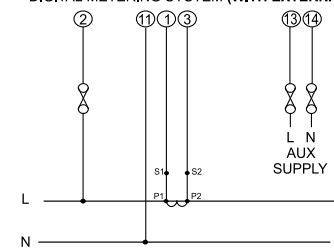

6. Pluggable Module

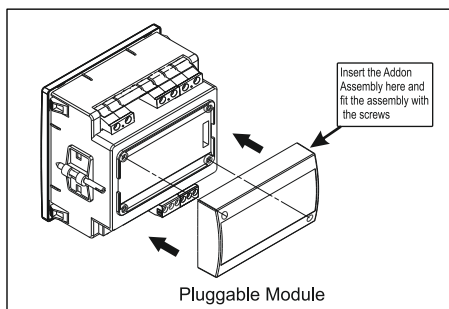

7. Specification

System

3 Phase 3 Wire / 4 Wire or Single Phase programmable on site

Inputs

Nominal Input Voltage (AC RMS)

System PT Primary Values 100VLL to 600VLL programmable on site. (57.7VLN to 346.4VLN)

System PT Secondary Values 100VLL to 600VLL programmable on site. (57.7VLN to 346.4VLN)

Max continuous input voltage 120% of Nominal Value

Nominal input voltage burden <0.3 VA approx. per Phase (at nominal 240V)

Nominal Input Current

max continuous input current 1A/5A

120% of Nominal value

Nominal input current burden <0.3 VA approx. per phase

System CT primary values Std. Values 1 to 9999A (1 or 5 Amp secondary)

System CT secondary values

1A / 5A, programmable on site

"-OL-" >121% of Nominal value (for voltage and current)

Overload Indication

Overload withstand

Voltage input 2 x Rated Value (1s application at 10s intervals) repeated 10 times

Current input 2 x nominal Value (1s application at 5min intervals) repeated 5 times

Auxiliary Supply

External Higher Aux. 100V to 550V AC-DC

External Higher Aux. Nominal Value 230V AC/DC 50/60 Hz for AC Aux

Aux Frequency Range 45 to 65 Hz

VA Burden With Addon card < 6 VA approx. (at nominal)

VA Burden With Ethernet card < 8 VA approx. (at nominal)

Operating Measuring Ranges

Voltage 20 ... 120 % of nominal Value

Current 1...120% of nominal value

Starting Current

as per IEC 62053-22 (0.5s/0.2s)

Frequency 45 to 66 Hz

Power Factor 0.5 Lag ... 1 ... 0.8 Lead

Total Harmonic Distortion 50% upto 15th harmonic

10% upto 31st harmonic

Reference conditions for Accuracy

Reference temperature 23°C ± 2°C

(as per IEC 62053-21)

Accuracy

Voltage ± 0.5% of nominal value

Current ± 0.5% of nominal value

Frequency ± 0.2 % of mid frequency

Active power ± 0.5% of nominal value

Reactive power ± 1.0% of nominal value

Apparent Power ± 0.5% of nominal value

Power Factor / Phase Angle ± 3°

Active energy as per IEC 62053-22 (0.5s)

as per IEC 62053-22 (0.2s) (optional)

Reactive energy Class 2 as per IEC 62053-23

Apparent energy class 1

THD (Voltage / Current) ± 3.0 %

Accuracy (for optional 0.2s)

Voltage ± 0.2% of nominal value

Current ± 0.2% of nominal value

Frequency ± 0.2 % of mid frequency

Active power ± 0.2% of nominal value

Apparent Power ± 0.2% of nominal value

Display

LCD Display with backlit

Response time to step input Approx. 1 sec.

Controls

User Interface 3 push buttons

Standards

EMC Immunity IEC 61326 - 1 : 2012

Immunity IEC 61000-4-3, 10V/m - Level 3 industrial Low level

Safety IEC 61010-1-2010, permanently connected use

IP for water & dust IEC 60529

Pollution degree 2

Installation Category III

Isolation

Protective Class 2

High Voltage Test

Input+Aux vs Surface 4 kV RMS, 50Hz, 1 min

Input vs Remaining Circuit 3.3 kV RMS, 50Hz, 1 min

Environmental conditions

Operating temperature -10 to +60 °C

Storage temperature -20 to +70 °C

Relative humidity 0 .. 95 % RH (Non condensing)

Warm up time 3 minute (minimum)

Shock (As per IEC 60068-2-27) Half Sine wave, Peak acceleration 30gn (300 m/s²), duration 18 ms

Vibration 10...150..10 Hz, 0.15mm amplitude

Number of Sweep cycles 10 per axis

Enclosure

Enclosure front IP 54

Enclosure back (Terminals) IP 20

Dimensions

Bezel Size 96mm x 96mm DIN 43718

Panel cut out 92mm+0.8 X 92mm+0.8

Overall Depth 75 mm

Panel thickness 1 - 3mm for self clicking

1 - 6mm for swivel screws

Weight 320 grams Approx.

Pulse output Option

Relay 1NO

Switching Voltage & Current 240 VAC , 5 A.

Default Pulse rate Divisor

1 per Wh (up to 3600W),

1 per kWh (up to 3600kW),

1 per MWh (above 3600 kW up to 30000 kW)

Pulse rate Divisors

Programable on site

10 1 per 10Wh (up to 3600W),

1 per 10kWh (up to 3600kW),

1 per 10MWh (above 3600 kW up to 30000 kW)

100 1 per 100Wh (up to 3600W),

1 per 100kWh (up to 3600 kW),

1 per 100MWh (above 3600 kW up to 30000 kW)

1000 1 per 1000Wh (up to 3600W),

1 per 1000kWh (up to 3600kW),

1 per 1000MWh (above 3600 kW up to 30000 kW)

Pulse Duration

60ms , 100ms or 200ms

Note :

- Refer TABLE 4 for details **
- Above conditions are also applicable for Reactive & Apparent Energy.

ModBus (RS 485) Option :

Protocol ModBus (RS 485)

Baud Rate 4.8k, 9.6k, 19.2k, 38.4k, 57.6kbps

Parity Odd or Even, with 1 stop bit, Or None with 1 or 2 stop bits

Ethernet Ethernet access on Modbus TCP/IP Protocol

Ethernet

Ethernet access on Modbus TCP/IP Protocol

Impulse Output :

Impulse LED For Energy testing

8. Connection for Optional Pulse Output / RS 485 (rear view of Multifunction Meter):

1. RS 485 Output with Relay1 & Relay2

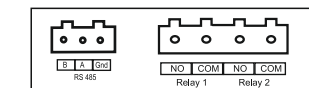

Model	Key features
END25RSA	RS485 interface + 2 Pulses outputs, accuracy class 0.5s
END25ETHA	Ethernet + data logging, accuracy class 0.2s

Full version of user's manual available here:

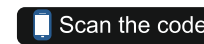

ETI Elektroelement d.o.o.
1411 Izlake
Slovenia

Tel. : +386 03 56 57 570
e-mail: eti@eti.si