

ETIMETER

Network Analyzers

- Network Analyzers **232**
- Modular Energy Counters **243**
- Metering Current transformers **251**

ETIMETER

Network Analyzers

Network Analyzer END20LRS

END20LRS is distinguished by a high measurement accuracy, legible backlight LCD display and an attractive price in relation to offered measuring functions. It is the ideal tool to control and monitor energy quality parameters and energy consumption in all industry branches, public utilities or in public service buildings.

Application - The END20L-RS mains analyser is designed to monitor electrical parameters and quality in three-phase or single-phase low and high voltage networks. The analyser provides accurate measurements of all types of electricity and has a wide range of options for setting the parameters displayed on the screen. The analyser can be connected both directly and via current and voltage transformers. Modbus protocol and pulse output for electricity meters are used for data transfer.

Features and measurements



- // power network parameters in 4- wire balanced and unbalanced systems,
- // Measurement of current and voltage THD distortion coefficients;
- // indications considering values of programmed ratios,
- // backlight LCD 3,5" screen,
- // digital transmission to the master system through the RS-485 interface (MODBUS RTU).
- // protection grade from the frontal side: IP65
- // high accuracy class,
- // 1x relay output for alarm and 1x pulse output
- // programmable output relay;
- // W-WH-VA-VAR-VARH power measurement;
- // function for measuring the maximum consumption of each phase;
- // password protection

Technical data

	END20LRS
Power supply voltage	85 - 253V AC / 90 - 300V DC
Measurement voltage phase, AC	2,8 - 276V AC
Measuring voltage linear, AC	5 - 480V AC
Measured current	0,002 - 6000 A
Nominal Frequency	47 - 63 Hz
Maximum power input	6 VA
Maximum current input consumption	0,05 VA
Maximum voltage input consumption	0,05 VA
Relay output	potential-free 1 NO (0,5A, 250V AC)
Counter pulse output	NPN (18-27V, 10-27mA), 1000 - 20000 imp/kW
Communication protocol	RS-485 (Modbus RTU)
Communication speed	4.8 / 9.6 / 19.2 / 38.4 kB
Operating temperature	-25 ... +55 °C
Overvoltage Category	300 V, III
Pollution degree	II
Protection degree	IP65 - front panel; IP20 - from the connection side
Dimensions H x W x D	96 x 96 x 77 mm
Installation opening H x W	92,5 x 92,5 mm
Standards	EN 61010-1, 61326-1, 61000-6-4



Network Analyzer END20LRS

Type	Description	Code		
END20LRS	Analyzer with RS485 port	004656950	500	1

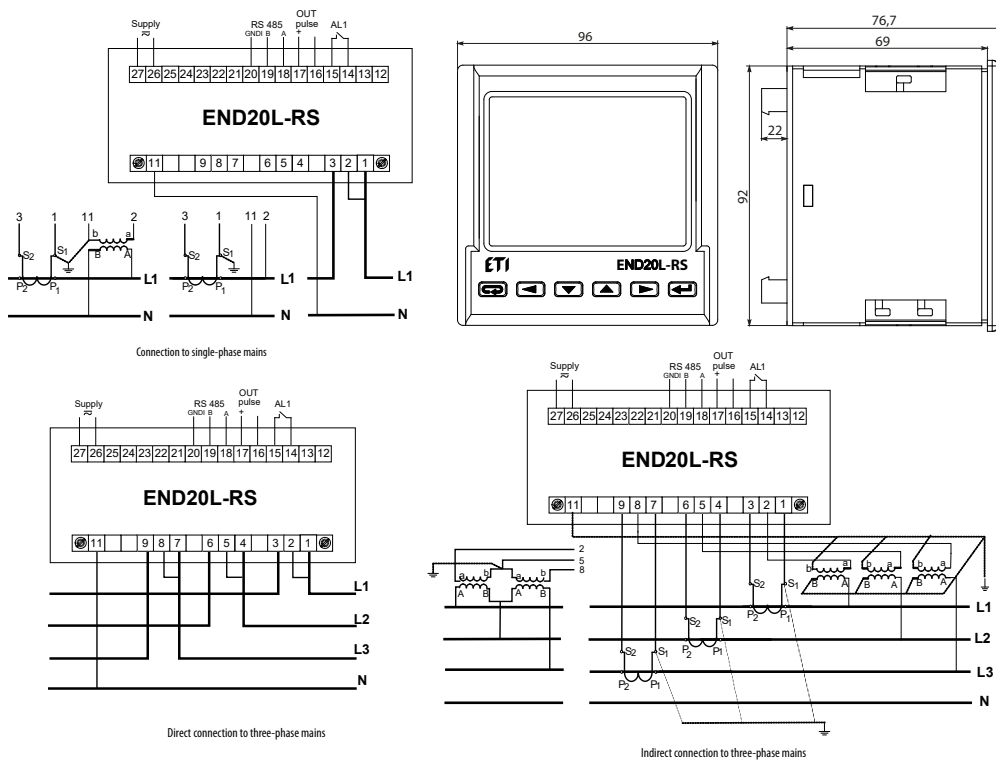

Network Analyzer END25RSA and END25ETHA

END25RSA and END25ETHA meters measure important electrical parameters in 3 phase 4 wire, 3 phase 3 wire and 1 phase 2 wire network. It measures electrical parameters like active / reactive / apparent energy, power and all basic parameter. The instrument has two optional outputs. It can be configured as pulse output for energy measurement, limit output, timer function and RTC relay.

END25RSA is basic instrument with RS485 interface (MODBUS RTU) and 2 programmable outputs (Potential free, very fast acting relay contacts). Configurable as pulse output which can be used to drive an external counter for energy measurement. Configurable as limit (alarm) switch).

END25ETHA is more advanced instrument, with ETHERNET interface (MODBUS TCP/IP), real time clock and data logging (8MB memory).

All devices can be configured and monitored via PC with free econ software.

Features

- // Measurement of 85 parameters, THD and harmonics up to 31st for voltage & current
- // Fully configurable LCD screen - possibility of programming 28 independent screens
- // Two optional outputs (END25RSA only). It can be configured as pulse output for energy measurement, limit output and timer function
- // RTC - real time clock (END25ETHA only)
- // Measurement archive – in-built 8MB Flash (END25ETHA only)
- // Data logging for:
 - // event logging (END25ETHA only)
 - // time based logging (END25ETHA only)
 - // load Profile logging (END25ETHA only)
- // LCD display with Back-light
- // Remote access of measured parameter via RS-485 (Modbus RTU) or through Ethernet interface (Modbus TCP/IP)
- // external dimension: 96 x 96mm

Technical data

	END25RSA	END25ETHA
Power supply voltage	V DC	100 - 550V AC/DC
Measurement voltage phase, AC		57,7 - 346,4V AC
Measuring voltage linear, AC		100 - 600V AC
Measuring current (primary winding)		1/5 A
Measuring current (secondary winding)		1 - 9999 A
Nominal Frequency	VA	45 - 65 Hz
Voltage measuring range		20 - 120 % of Un
Current measuring range	VA	1 - 120 % of In
Maximum current/voltage input consumption	V AC	<0,3 VA
Relay output	potential free, 2 NO (5A, 240V AC)	-
Communication protocol	RS-485 (Modbus RTU)	Ethernet (Modbus TCP/IP)
Communication speed	4.8 / 9.6 / 19.2 / 38.4 / 57,6 kB	-
Operating temperature	Hz	-10 ... +60 °C
Overvoltage Category	%	III
Pollution degree	°C	II
Protection degree		IP54 - front panel; IP20 - from the connection side
Dimensions H x W x D	IP	96 x 96 x 75 mm
Installation opening H x W	mm2	92 x 92 mm
Standards	EN 61010-1-2010, 61326-1, 61000-4-3, 60529, 62053	



Network Analyzer END25

Type	Description	Code		
END25RSA	Analyzer with RS485 port and 2x relay outputs	004656954	400	1
END25ETH	Analyzer with ETHERNET port, RTC and 8MB memory (data logging).	004656955	400	1

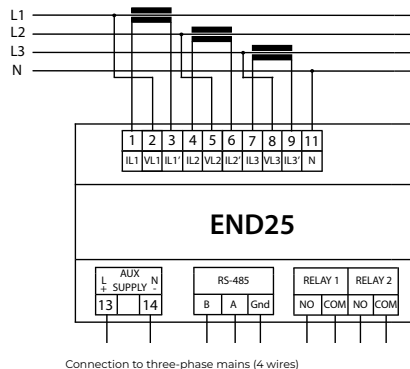
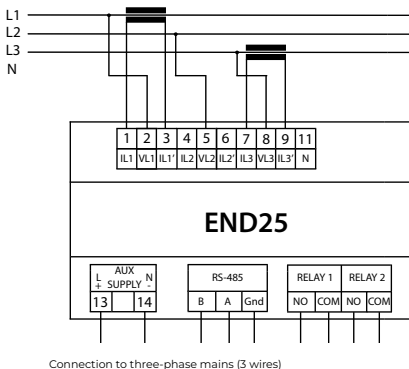
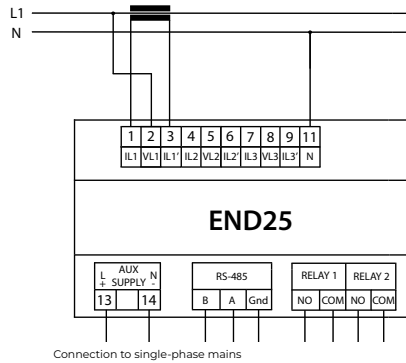
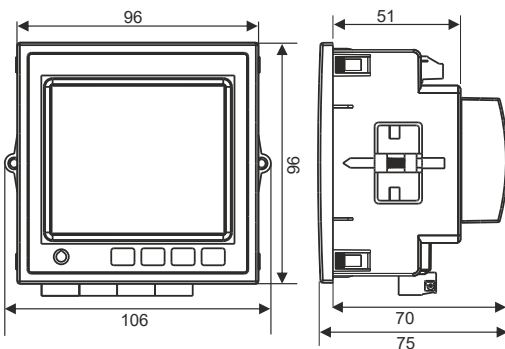

Note: The END25-ETH analyser has no relay outputs and instead of RS-485 terminals there is an RJ-45 connector for Ethernet protocol connection. The measurement and supply terminals are unchanged.

Measured Parameters

Import Active Energy	Power Factor L1	Max Inductive Var Demand	Current L2	Phase Reversal Indication
Export Active Energy	Power Factor L2	Max Capacitive Var Demand	Current L3	Current Reversal Indication
Inductive Reactive Energy	Power Factor L3	Run Hour	System Current THD	Phase Absent Indication
Capacitive Reactive Energy	System Phase Angle	Number of Interruptions	Current L1 THD	Old Import Active Energy
Apparent Energy	Phase Angle L1	System Voltage	Current L2 THD	Advanced version
System Active Power (kW)	Phase Angle L2	Voltage L1	Current L3 THD	Old Export Active Energy
Active Power L1 (kW)	Phase Angle L3	Voltage L2	Individual Harmonics of VL1 (Up to 31st Harmonics)	Old Inductive Reactive Energy
Active Power L2 (kW)	KVA Demand	Voltage L3	Individual Harmonics of VL2 (Up to 31st Harmonics)	Old Capacitive Reactive Energy
Active Power L3 (kW)	Current Demand	Voltage L12	Individual Harmonics VL3 (Up to 31st Harmonics)	Old Apparent Energy
System Re-active Power (kVAr)	Import kW Demand	Voltage L23	Individual Harmonics IL1 (Up to 31st Harmonics)	Old Run Hour
Re-active Power L1 (kVAr)	Export kW Demand	Voltage L31	Individual Harmonics IL2 (Up to 31st Harmonics)	Old On Hour
Re-active Power L2 (kVAr)	Inductive Var Demand	System Voltage THD	Individual Harmonics IL3 (Up to 31st Harmonic)	Old Number of Interruptions
Re-active Power L3 (kVAr)	Capacitive Var Demand	Voltage L1 THD	Individual Harmonics IL3 (Up to 31st Harmonics)	Old Max Current Demand
System Apparent Power (KVA)	Max Current Demand	Voltage L2 THD	Neutral Current	Old Max VA Demand
Apparent Power L1 (KVA)	Max KVA Demand	Voltage L3 THD	Frequency	Old Max Import W Demand?
Apparent Power L2 (KVA)	Max Import kW Demand	Parameters	RPM	Old Max Export W Demand
Apparent Power L3 (KVA)	Max Export kW Demand	System Current		Old Max Inductive VAr Demand
System Power Factor	On Hour	Current L1		Old Max Capacitive VAr Demand

Note: 1. Energy on display is autoranging & unit for Energy parameters on modbus are dependent on CTPT ratio or unit selected by user.

2. Parameters are available only on modbus.

Network Analyzer ENA3, ENA3D

Application

Three phase network analyzer is intended for measuring electrical parameters of various loads in industry such as voltage, current, power factor ($\cos \varphi$), power (W, VAR, VA), single and total harmonic distortion V-I, work hours, ambient temperature. Available in two versions, ENA3 for door mounting and ENA3D for DIN-rail mounting. Display integrated in device shows parameters for each phase separately. 3 independent programmable contact free output relays can be set up for different alarms. Programing is possible directly on device or with connecting to PC by using communication adapter SCUSB485 and free monitoring software not included in package, available on web.

Advantages

- /// 3 independent programmable alarm relay outputs (NO)
- /// Programmable alarm relay (Under/Overvoltage - Overcurrent - Frequency - Low power factor $\cos \varphi$ - Total harmonic distortion)
- /// 144x144 panel mounting or 9 modules DIN
- /// Self-extinguished material UL94 V0

Measurements

- /// Power factor $\cos \varphi$ inductive & capacitive (four quadrants)
- /// Three phase voltage & current
- /// Power: W - WH - VA - VAR - VARH
- /// Single and total harmonic distortion (THDs) V/I
- /// Working hours
- /// Ambient temperature

Communication

- /// serial interface: TTL, RJ11 connector
- /// protocol: Proprietary / MODBUS RTU

Technical data

		ENA3	ENA3D
Supply voltage AC $\pm 10\%$	V ~	3x400 + N, 230 L/N	
Nominal Frequency	Hz	50 - 60 (45 - 65)	
Power consumption (max. AC)	VA	4	
Rated Current (CT)	A	5/1...50000	
Immunity Time For Microbreakings	ms	< 50ms	
Display Type	-	3 Display - 4 Digit - 7 Segment	
Measuring Type	-	True RMS	
$\cos \varphi$ (L/L)	-	0.00 ... 1.00 $\pm 1\%$	
Voltage (N/Lx)	VA ~	100 ... 280 $\pm 1\%$	
Voltage (L/L)	VA ~	180 ... 490 $\pm 1\%$	
Current (CT)	A	0.05 ... 5.5 $\pm 0.5\%$	
Active Power (Lx)	W	Class 1	
Reactive Power (Lx)	VAR	Class 1	
Apparent Power (Lx)	VA	Class 1	
THD of Volt or Current	%	0 ... 255	
Work Hours	h	0 to 9999 (with multiplier)	
Ambient Temperature	$^{\circ}\text{C}$	00C...+60 $^{\circ}\text{C}$ (/ $^{\circ}\text{F}$)	
Working temperature	$^{\circ}\text{C}$	-20 ... +60	
Storage temperature	$^{\circ}\text{C}$	-30 ... +70	
Electrical Insulation	kV	4	
Overvoltage Category	-	II	
Protection degree	IP	41 Front Cover - 20 Terminal Block	
Pollution degree	-	2	
Relative Humidity w/o cond.	%	95	
Altitude up to	m	2000	
Weight	g	680	550
Dimensions	mm	149 x 149 x 60	157 x 89 x 60
Standards	-	2006/95/EC - Low Voltage, 2004/108/EC - EMC	





ENA3



ENA3D

Network Analyzer

Type	Description	Code	 g	
ENA3	3-phase network analyzer for panel mounting	004656578	760	1/30
ENA3D	3-phase network analyzer for DIN-rail mounting	004656579	630	1/40

Communication adapter SCUSB485 is not included and must be ordered separately under reference code: 004656577



Dimensions

144x144 (mm)

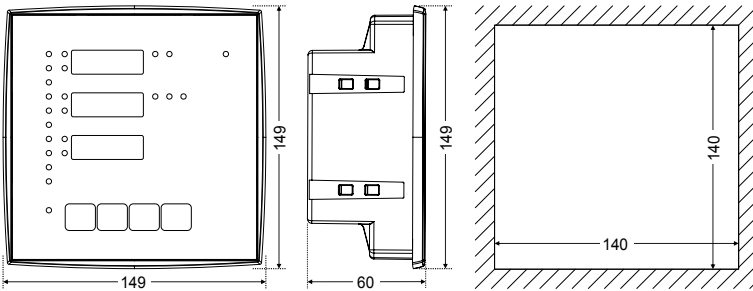

9 MOD (mm)

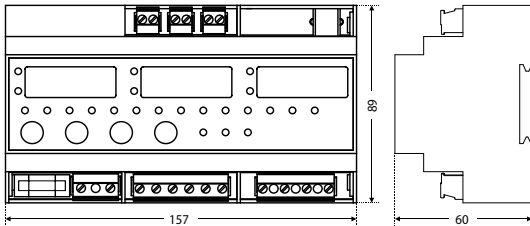

Wiring Diagrams

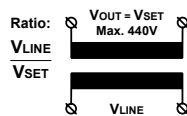
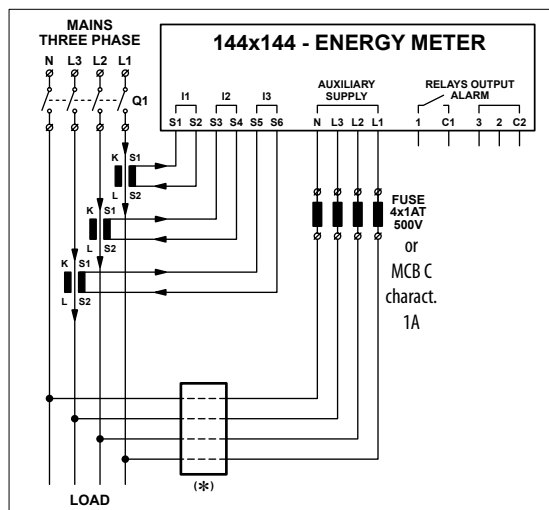
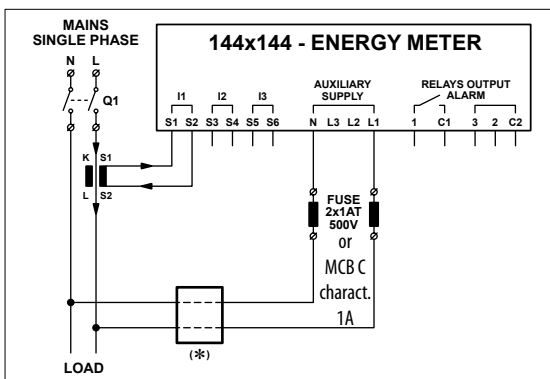

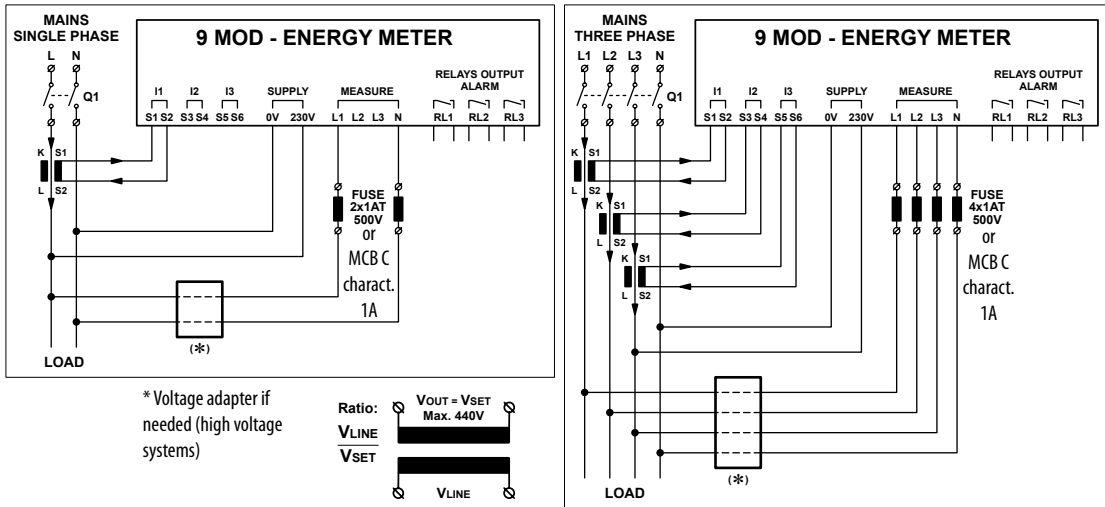

ETIMETER

Adapter TTL<>USB<>RS485

Features

- // Self-extinguished material UL94 v0)
- // USB and RS-485 serial interface with cables
- // Surge protection on RS-485 line
- // Connect remote serial device to a PC
- // Power and data flow indicator for troubleshooting
- // The RS-485 standard supports half-duplex (2 wire)
- // Real time transfer ASCII protocol
- // Compact size - 2 module - 35mm
- // DIN rail mounting EN 50 022





Technical data

Supply voltage AC -15/+10 %	V ~	230
Nominal Frequency	Hz	50 - 60 (range 47 - 63)
Power consumption (max. AC)	VA	0,5
Serial Interface	-	1 USB + 1 RS-485
Protocol Type	-	Owner - Modbus RTU - ASCII
Baud Rate	kbit/s	≤ 115,2
Max device connection (TTL/RS-485)	V ~	1...99
Working temperature	°C	-10 /+50
Storage temperature	°C	-30 /+70
Electrical Insulation (USB_TTL/RS485)	kV	1
Electrical Insulation (N_L/RS485)	kV	3
Overvoltage Category	-	II
Protection degree	IP	20
Pollution degree	-	2
Relative Humidity w/o cond.	RH %	95
Altitude up to	m	200
Weight	g	95
Dimensions	mm	90 x 36 x 63,4
Standards	-	2006/95/EC, 2004/108/EC

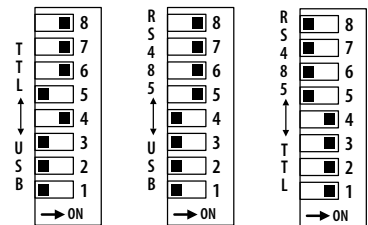
DIP-switch configuration



Adapter TTL<>USB<>RS485

Type	Description	Code		
SCUSB485	Adapter TTL<>USB<>RS485	004656577	390	1/30

Interface converter TTL > USB <> RS485 can be used with ENA3, ENA3D or PFC 8 DB, PFC 12 DB.
Software (monitoring and programming via PC) and drivers available (free) for Windows on ETI webpage



Dimensions

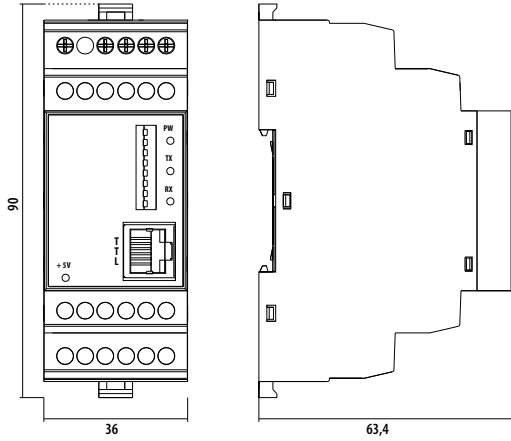

Wiring Diagrams

A - USB <--> RS485

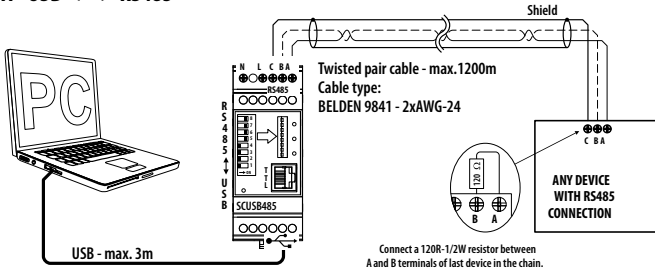

B - USB <--> TTL

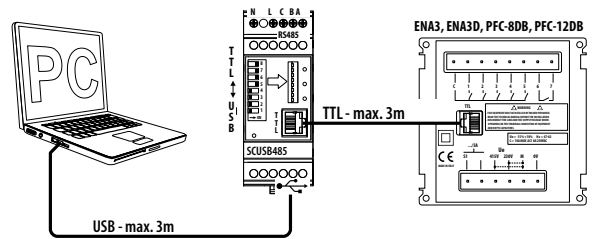

C - USB <--> 485 - 485 <--> TTL

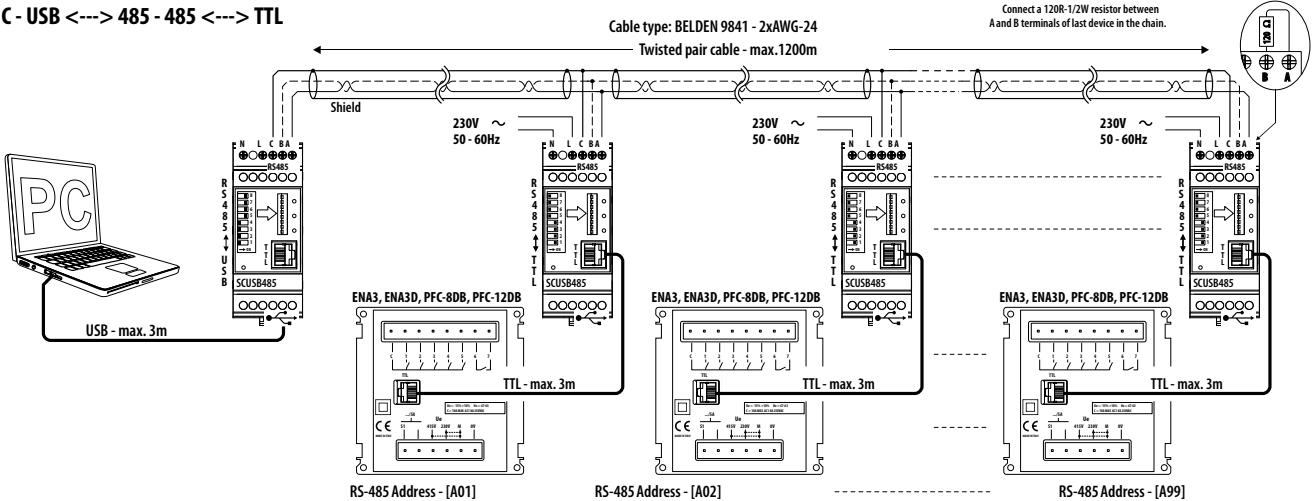

Download Software and Driver on Website: www.etigroup.eu/support

Network Analyzer ENA33LCD

Description

The power line analyser for accurate monitoring of main electrical parameters in three-phase or single-phase networks. The instrument measures continuous voltage and current according to the norm EN 61000-4-30. Thanks to precise measurement and a high sampling rate, it is also ideal for particular measuring points in electrical energy monitoring systems. Integrated communication interface RS485 with Modbus RTU protocol allows using it as a measuring point in SCADA systems.

Advantages

- // TN, TT, IT (virtual N) 3 phase networks
- // 3 voltage and 3 current inputs
- // calculated current of neutral wire
- // continual sampling frequency 6,4 kHz
- // THD U and THD I measurement
- // odd harmonics of U and I till 19th order (L1, L2, L3)
- // power factor (L1) and $\cos\phi$ (L1, L2, L3)
- // P+/-, Q+/-, S (L1, L2, L3, Σ)
- // E active +/- , E reactive L +/- , E reactive C +/-
- // measurement according the standard EN 61000-4-30
- // measuring phase-phase voltage from 0 ... 520 VAC
- // memory for maximums / minimums of avg values
- // memory for recording of last 20 supply voltage interruptions
- // real-time clock with supercap backup
- // communication interface RS485 with Modbus RTU protocol



Technical data

		ENA33LCD
Supply voltage	VAC	85 ... 265
System frequency	Hz	50 / 60
Current measuring range	A	0.01 ... 8 A (max permanent current 10 A)
Voltage measuring range L - N	VAC	0 ... 600
Power consumption	VA	1,5
Sampling frequency 50/60Hz	kHz	25,6 / 30,72
Number of inputs / outputs	-	/
Primary voltage measuring transformer ratio		1 ... 750000
Primary current measuring transformer ratio		1 ... 10000
Maximum number of registered auxiliary supply power cuts		20
Communication port	-	RS485 insulated
Communication protocol	-	Modbus RTU
Communication speed	kBd	9.6 / 19.2 / 38.4 / 57.6 / 115
Overvoltage Category	V	300, III
Pollution degree	-	II
Protection degree	IP	IP20 rear panel / IP54 front panel
Dimensions H x W x D	mm	90 x 90 x 67
Panel cut-out dimensions	mm	92 x 92
Site depth	mm	90
Standards		EN 61010-1, EN 62586-1, EN 61000-6-2, EN 61000-6-3

Measured parameters

Parameter	L1	L2	L3	L1-L2	L2-L3	L3-L1	Σ L1-L3	Max	Min	AVG	Measuring range	Displayed range	Accuracy
Phase voltage, L – N	✓	✓	✓					✓	✓	✓	10 ... 600 V	0 ... 1 MV	±0.2 %
Line voltage, L – L				✓	✓	✓		✓	✓	✓	18 ... 1000 V	0 ... 1 MV	±0.2 %
Frequency	✓							✓	✓	✓	40 ... 70 Hz	40 ... 70 Hz	10 mHz
Current	✓	✓	✓				✓	✓	✓	✓	0.01 ... 6 A	0 ... 1 MA	±0.2 %
cosφ	✓	✓	✓					✓	✓	✓	0.01 L ... 0.01 C	0.01L ... 0.01C	±1 %
Power factor	✓	✓	✓					✓	✓	✓	0.01 L ... 0.01 C	0.01L ... 0.01C	±1 %
THDU L-N	✓	✓	✓					✓	✓	✓	0 ... 999 %	0 ... 999 %	±5 %
THDU L-L				✓	✓	✓		✓	✓	✓	0 ... 999 %	0 ... 999 %	±5 %
Under and over deviation L	✓	✓	✓					✓	✓	✓			
Under and over deviation L-L	✓	✓	✓					✓	✓	✓			
Voltage unbalance u2, u0								✓	✓	✓			
THDI	✓	✓	✓					✓	✓	✓	0 ... 999 %	0 ... 999 %	±5 %
TDD	✓	✓	✓					✓	✓	✓	0 ... 999 %	0 ... 999 %	±5 %
Voltage harm. (up to 40th)	✓	✓	✓								0 ... 999 %	0 ... 999 %	d. 1
Current harm. (up to 40th)	✓	✓	✓								0 ... 999 %	0 ... 999 %	d. 1
Voltage, current asymmetry								✓	✓	✓	0 ... 100 %	0 ... 100 %	0.3 %
K-factor	✓	✓	✓										
Current unbalance i2, i0								✓	✓	✓	0 ... 99.9 %	0 ... 99.9 %	d. 1
Active power	✓	✓	✓				✓	✓	✓	✓	0 ... 15.3 kW	0 ... 999 MW	±0.4 %
Reactive power	✓	✓	✓				✓	✓	✓	✓	0 ... 15.3 kvar	0 ... 999 MVar	±0.4 %
Apparent power	✓	✓	✓				✓	✓	✓	✓	0 ... 15.3 kVA	0 ... 999 MVA	±0.4 %
Distortion power	✓	✓	✓				✓	✓	✓	✓			±0.5 %
Active energy +/-	✓	✓	✓				✓				0 ... 999 GWh	0 ... 999 GVh	d. 0.5
Reactive ind. energy +/-	✓	✓	✓				✓				0 ... 999 Gvarh	0 ... 999 Gvarh	d. 2
Reactive cap. energy +/-	✓	✓	✓				✓				0 ... 999 Gvarh	0 ... 999 Gvarh	d. 2
Temperature											-40 ... +125°C		1°C

Universal Analyzer

Type	Description	Code		
ENA33LCD	Panel mounting 96x96	004656910	460	1

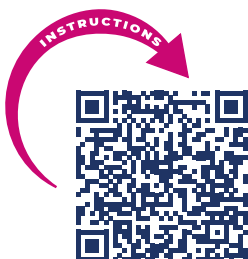

Dimensions

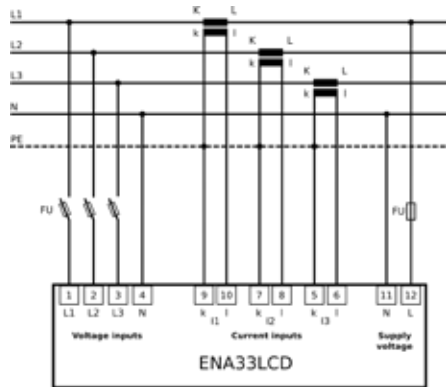
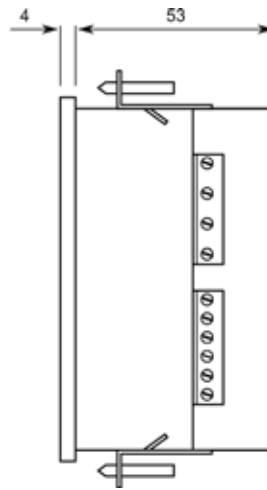
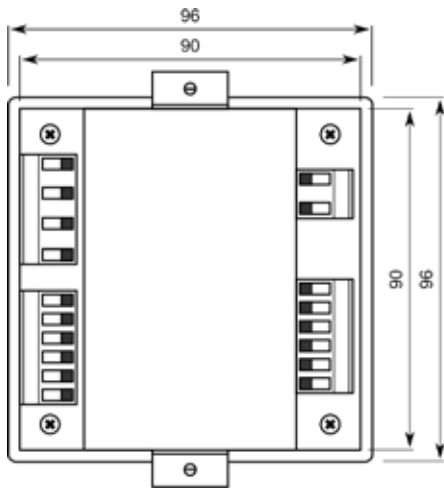

3-ph connection grid TN-C-S (TN-C)

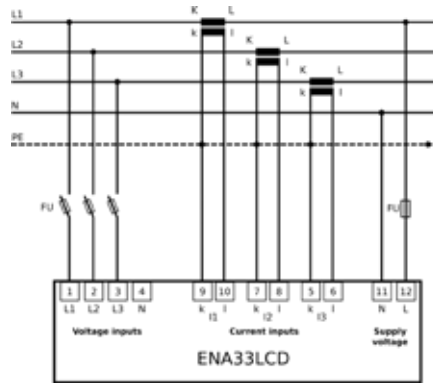

3-ph connection grid TN-C-S without N

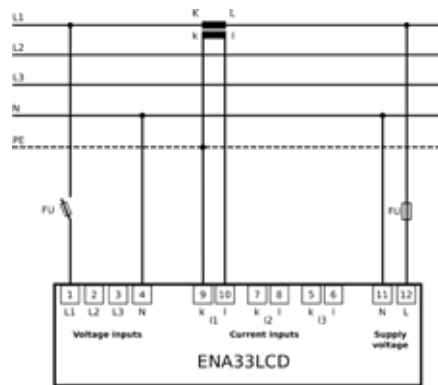

1-ph connection

ETIMETER

Modular Energy Counters

EVSE-ready 3-phase Modular Energy Meter 80A



- EVSE (Electric vehicle supply equipment) ready 3 phase modular Energy Meter 80A with RS485 port, pulse output:
- // compact three-phase direct connected DIN-rail mounting meter.
 - // class B for active energy and class 2 for reactive energy
 - // maximum current 80 A (I_{Lmax}).
 - // RS485 (modbus) communication
 - // tariff input.
 - // 70°C ambient operational temperature. (EVSE ready)
 - // MID certificate available

Meter is intended for energy measurements in three-phase electrical power network and can be used in residential, industrial and utility applications. Meter measures energy directly in 3-wire and 4-wire networks according to the principle of fast sampling of voltage and current signals. A built-in microprocessor calculates energy and other electrical quantities from the measured signals. It also controls LCD, LED, IR and RS485 communication. A capacitive touch button on the front of the energy meter enables access to switch between measurements and settings in the menu. Connecting terminals can be sealed up against non-authorized access with protection covers.

Features:

- // Three phase direct connected DIN-rail mounting meter.
- // Class 1 for active energy according to EN 62053-21 and class B according to EN 50470-3.
- // Class 2 for reactive energy according to IEC 62053-23.
- // Bidirectional energy measurement (import/export).
- // Maximum current 80 A (I_{Lmax}).
- // Display segment Matrix LCD.
- // LCD display with backlight.
- // Multifunctional front red LED.
- // Measurements of:
 - // power (active/reactive/apparent),
 - // energy (active/reactive/apparent, each phase and total),
- // voltage for each phase,
- // current for each phase,
- // phase to phase voltage
- // phase to phase angle,
- // frequency,
- // power factor (for each phase and total),
- // power angle (for each phase and total),
- // active tariff,
- // THD of voltage,
- // THD of current.
- // Modbus RS485 Serial communication
- // 2nd multifunction pulse output (valid only for IE38MS).
- // RS485 Serial communication (valid only for IE38MD).
- // NFC (option) enables an easy setting and downloading meter data.
- // M-bus Serial communication (valid only for IE38MM).
- // Tariff input (230 V AC)
- // Tariff management (up to 6 tariffs manageable via communication).
- // -25°C ... 70°C ambient operation temperature.
- // Sealable terminal cover.
- // DIN-rail mounting according to EN 60715.
- // 3 DIN modules width.

Modular Energy Counter 3MEM 80 with MID certificate

Type	Description	Code		
3MEM80-BEVRSP0-MID	3phase 80 A, SO(Pulse output), RS485, EVSE ready	004657210	248	1/96
3MEM80-BPO-MID	3phase 80 A, 2xSO(Pulse output), EVSE ready	004657211	248	1/96
3MEM80-BMB-MID	3phase 80 A, SO(Pulse output), M-bus, EVSE ready	004657212	248	1/96



General hardware features

	3MEM80-BPO-MID	3MEM80-BMB-MID	3MEM80-BEVRSP0-MID
MID approval	✓	✓	✓
Pulse output S01	✓	✓	✓
Pulse output S02	✓	✗	✗
Tariff input	✓	✓	✓
85°C display	✓	✓	✓
MODBUS comm. Protocol RS485	✗	✗	✓
M-bus serial comm.	✗	✓	✗



Technical Data

Rail mounting		DIN EN60715	Pulse output S0 ₁	
Main inputs			Pulse rate	500 imp/kWh
Contacts capacity - Flexible (Rigid)	1.5 mm ² ...25 (16) mm ²		Pulse duration	32 ms ± 2 ms
Connection screws	M5		Rated voltage DC (max)	27 V
Max torque	3.5 Nm (PH2)		Switched current (max)	27 mA
Length or removed isolation	10 mm		Standard	EN 62053-31 (A&B)
Auxiliary contacts			Pulse output S0₂ (option)	
Contact capacity	0.05 mm ² ...1.5 mm ²		Type	Programmable
Screws	M3		Rated voltage DC (max)	27 V
Max torque	0.6 Nm		Switched current (max)	27 mA
Length or removed isolation	8 mm		M-BUS Serial communication (option)	
Measuring input			Type	M-BUS
Type	three-phase (3W4, 3W3, 2W3) single-phase (1W)		Speed	300 bit/s to 9600 bit/s (default 2400 bit/s)
Reference (nominal) current (I _{ref})	5 A		Protocol	M-BUS
Maximum current (I _{max})	80 A		Primary address	0 – (default)
Minimum current (I _{min})	0.25 A		Tariff input	
Transitional current (I _{tr})	0.5 A		Rated voltage	230 V (-20 %...+15 %)
Starting current	20 mA		Input resistance	360 kΩ
Power consumption at I _{ref}	< 0.1 VA		RS485 Serial communication (option)	
Nominal voltage (U _n)	3x230 V/400 V (-20 %...+15 %)		Type	RS485
Power consumption per phase at U _n	< 8 VA		Speed	1200 bit/s to 115200 bit/s (default 115200 bit/s)
Nominal frequency (f _n)	50 Hz and 60 Hz		Frame	8, N, 2
Minimum measuring time	10 s		Protocol	MODBUS RTU
			Address	33 – (default)
Accuracy			Ambient conditions and Safety	
Active energy	class 1 EN 62053-21 class B EN 50470-3 ±1.5 % from I _{min} to I _{tr} ±1 % from I _{tr} to I _{max}		Temperature and climatic condition	EN 62052 11
	Reactive, Apparent energy	class 2 IEC 62053-23 ±2.5 % from I _{min} to I _{tr} ±2 % from I _{tr} to I _{max}	Dust/water protection	IP50
			Operating temp. range	-25°C... +70°C (non-condensing humidity)
Voltage	±1 % of measured value		Storage temp. range	-40 °C... +85°C
Current	±1 % of I _{ref} from I _{st} to I _{ref} ±1 % of measured value from I _{ref} to I _{max}		Enclosure material	self-extinguish complying UL94V
Active Power	±1 % of nominal power (U _n ⁿ *I _{ref}) from I _{st} to I _{ref} ±1 % of measured value from I _{ref} to I _{max}		Indoor meter	yes
Reactive, Apparent power	±2 % of nominal power from I _{st} to I _{ref} ±2 % of measured value from I _{ref} to I _{max}		Degree of pollution	2
Frequency	±0.5 % of measured value		Protection class	II
LCD			Installation category	300 V _{ms} cat.III
Display type	Matrix (128 x 64)		Standard	IEC 62052-31
Illumination	white (normal operation) / red (alarm indication)		Mechanical environment	M1
LED			Electromagnetic environment	E2
Colour	red		Humidity	non condensing
Pulse rate	1000 imp/kWh		Installation	DIN Rail 35 mm
LED on	no load indication		Dimensions (W x H x D)	52.5 mm x 91.7 mm x 68.2 mm
			Colour	RAL 7035
			EU Directives	EU Directive on Measuring Instruments 2014/32/EU. EU Directive on EMC 2014/30/EU. EU Directive on Low Voltage 2014/35/EU. EC Directive WEEE 2002/96/EC.

3-phase Modular Energy Meter 65A

3 phase modular Energy Meter 65A , various options of communication, measurement:

- // Compact three-phase direct connected DIN-rail mounting meter
- // 3 DIN modules width
- // Maximum current 65 A (Imax)
- // Class 1 for active energy and class 2 for reactive energy
- // Optional: RS485, M-bus comm., Tariff input, pulse output



The meter can be equipped with the following communications and features:

- // RS485 serial communication with the MODBUS protocol.
- // M-bus serial communication, which enables data transmission and thus connection of the measuring places into the network for the control and management with energy.
- // Tariff input. Tariff input provides measurement of two tariffs for selected energy registers.
- // A built-in pulse output (option). It is designed for sending data to the devices for checking and monitoring consumed energy.

Features:

- // Three phase direct connected DIN-rail mounting meter.
- // Class 1 for active energy according to EN 62053- 21, class B according to EN 50470-3.
- // Class 2 for reactive energy according to EN 62053-23.
- // Bidirectional energy measurement (import/export).
- // Maximum current 65 A (Imax).
- // Basic current 5 A (Ib).
- // Reference voltage 3x230 V/400 V (Un).
- // Voltage operating range (-20 % ... +15 %) Un.
- // Reference frequencies 50 Hz and 60 Hz.
- // Power consumption voltage circuit < 8 VA at Un per phase.
- // Power consumption current circuit < 0.8 VA at Ib per phase.
- // Temperature range climatic condition as indoor meter according EN 50470.
- // Display 7+1 digit (100 Wh resolution).
- // Multifunctional front red LED.
- // LED constant 1000 imp/kWh.
- // Measurements of:
 - // power (active/reactive/apparent)
 - // energy (active/reactive/apparent, each phase and total),
 - // voltage for each phase,
 - // current for each phase,
 - // phase to phase voltage
 - // phase to phase angle,
 - // frequency,
 - // power factor (for each phase and total),
- // power angle (for each phase and total),
- // active tariff (option),
- // THD of voltage,
- // THD of current.
- // Pulse output according to EN 62053-31 (option).
- // Tariff input (option).
- // RS485 Serial communication (option).
- // M-bus Serial communication (option).
- // DIN-rail mounting according to EN 60715.
- // Sealable terminal cover.

Modular Energy Counter 3MEM65

Type	Description	Code		
3MEM65-BPO-MID	3 phase, 65A, Pulse output	004657213	248	1/96
3MEM65-BT-MID	3 phase, 65A, Tariff input	004657214	248	1/96
3MEM65-BRS-MID	3 phase, 65A, RS485	004657215	248	1/96
3MEM65-BMB-MID	3 phase, 65A, M-bus	004657216	248	1/96

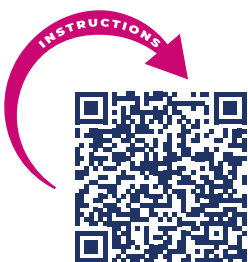

Technical Data

Rail mounting	DIN EN60715	Pulse output (option)	
Main inputs		Pulse rate	1000 imp/kWh
Contacts capacity - Rigid (flexible)	1.5 mm ² ...25 (16) mm ²	Pulse duration	32 ms ± 2 ms
Connection screws	M5	Rated voltage DC (max)	27 V
Max torque	3.5 Nm (PH2)	Switched current (max)	27 mA
Length or removed isolation	10 mm	Standard	EN 62053-31 (A&B)
Auxiliary contacts		M-BUS Serial communication (option)	
Contact capacity	1 mm ² ... 2.5 mm ²	Type	M-bus
Screws	M3	Speed	300 bit/s to 9600 bit/s (default 2400 bits/s)
Max torque	1.2 Nm	Protocol	M-bus
Length or removed isolation	8 mm	Address	0 – (default)
Measuring input		RS485 Serial communication (option)	
Type	three phase (4u)	Type	RS485
Reference (nominal) current (I _{ref})	5 A	Speed	1200 bit/s to 38400 bit/s (default 38400 bit/s)
Maximum current (I _{max})	65 A	Frame	8, N, 2
Minimum current (I _{min})	0.25 A	Protocol	MODBUS RTU
Transitional current (I _{tr})	0.5 A	Address	33 – (default)
Starting current	20 mA	Tariff input (option)	
Power consumption at I _{ref}	< 0.1 VA	Rated voltage	230 V (-20 % +15 %)
Nominal voltage (U _n)	3x230 V/400 V (-20 %...+15 %)	Input resistance	450 kΩ
Power consumption per phase at U _n	< 8 VA	Ambient conditions and Safety	
Nominal frequency (f _n)	50 Hz and 60 Hz	Temperature and climatic condition	EN 62052 11
Minimum measuring time	10 s	Dust/water protection	IP50
Accuracy		Operating temp. range	-25°C... +55°C (non-condensing humidity)
Active energy	class 1 EN 62053-21 class B EN 50470-3 ±1.5 % from I _{min} to I _{tr} ±1 % from I _{tr} to I _{max}	Storage temp. range	-40 °C... +70°C
		Enclosure material	self-extinguish complying UL94 V
Reactive, Apparent energy	class 2 EN 62053-23 ±2.5 % from I _{min} to I _{tr} ±2 % from I _{tr} to I _{max}	Indoor meter	yes
		Degree of pollution	2
Voltage	±1 % of measured value	Protection class	II
		Installation category	300 V _{ms} cat.III
Current	±1 % of I _{ref} from I _{st} to I _{ref} ±1 % of measured value from I _{ref} to I _{max}	Standard	IEC 62052-31
		Mechanical environment	M1
Active Power	±1 % of nominal power (U _n *I _{ref}) from I _{st} to I _{ref} ±1 % of measured value from I _{ref} to I _{max}	Electromagnetic environment	E2
		Humidity	non condensing
Reactive, Apparent power	±2 % of nominal power from I _{st} to I _{ref} ±2 % of measured value from I _{ref} to I _{max}	Installation	DIN Rail 35 mm
		Dimensions (W x H x D)	53.6 mm x 84 mm x 64 mm (69 mm)
Frequency	±0.5 % of measured value	Colour	RAL 7035
		EU Directives	EU Directive on Measuring Instruments 2014/32/EU. EU Directive on EMC 2014/30/EU. EU Directive on Low Voltage 2014/35/EU. EC Directive WEEE 2002/96/EC.
LCD			
Number of digits:	8 (7+1)		
Height of digits:	4.52 mm		
LED			
Colour	red		
Pulse rate	1000 imp/kWh		
LED on	no load indication		

EVSE-ready 3-phase Modular Energy Meter 40A

EVSE (Electric vehicle supply equipment) ready 3 phase modular Energy Meter 40A with RS485 port:



- // Compact three-phase direct connected DIN-rail mounting meter
- // 3 DIN modules width
- // According to requirements of PTB, VDE and OCMF
- // Class 1 for active energy and class 2 for reactive energy
- // Maximum current 40 A (I_{max})
- // 70°C ambient operation temperature (EVSE ready)
- // Possibility to connect only on one phase

The 3MEM40-EVRS energy meters are intended for energy measurements in the three-phase and one phase electrical charger stations due to allowed high temperature operation (up to 70°C). Measuring energy directly in 4-wire networks according to the principle of fast sampling of voltage and current signals. A built-in microprocessor calculates power, energy, current, voltage, power factor, power angle, frequency, harmonics of THD voltage and THD current harmonics.

Features:

- // 3 DIN modules width three phase direct connected DIN-rail mounting meter
- // Class 1 for active energy according to EN 62053-21
- // Reference frequency 50 Hz or 60 Hz
- // Maximum current 40 A (I_{max})
- // Basic current 5 A (I_b)
- // Reference voltage 3×230 V/400 V (U_n)
- // Voltage operating range (-20 % ... +15 %)U_n
- // Two row display 6+2 digit (10 Wh resolution) with backlight
- // Multifunctional front LED
- // RS485 Serial communication
- // Measurement of:
 - // power (active/reactive/apparent),
 - // energy (active/reactive/apparent) each phase and total),
 - // voltage (each phase),
 - // current (each phase),
 - // phase to phase voltage,
 - // phase to phase angle,
 - // frequency,
 - // power factor (for each phase and total),
 - // power angle (for each phase and total),
 - // THD of voltage,
- // THD of current.
- // Possibility to connect only on one phase (on L3).
- // Remote control of backlight LCD.
- // 70°C ambient operation temperature.
- // Sealable terminal cover.

Modular Energy Counter 3MEM40

Type	Description	Code		
3MEM40-EVRS	3 phase, 40A, RS485, EVSE	004657200	248	1/96



Technical Data

Rail mounting	DIN EN60715	RS485 Serial communication (option)	
Main inputs		Type	RS485
Contacts capacity - Rigid (flexible)	1.5 mm ² ...25 (16) mm ²	Speed	1200 bit/s to 115200 bit/s (default 115200 bit/s)
Connection screws	M5	Frame	8, N, 1
Max torque	3.5 Nm (PH2)	Protocol	MODBUS RTU
Length or removed isolation	10 mm	Address	33 – (default)
Auxiliary contacts		Ambient conditions and Safety	
Contact capacity	1 mm ² ... 2.5 mm ²	Temperature and climatic condition	EN 62052 11
Screws	M3	Dust/water protection	IP50
Max torque	1.2 Nm	Operating temp. range	-25°C... +70°C
Length or removed isolation	8 mm	Storage temp. range	-30 °C... +80°C
Measuring input		Enclosure material	self-extinguish complying UL94 V
Type	three phase (4u)	Indoor meter	yes
Reference (nominal) current (I _{ref})	5 A	Degree of pollution	2
Maximum current (I _{max})	40 A	Protection class	II
Minimum current (I _{min})	0.25 A	Installation category	300 V _{max} cat.III
Transitional current (I _{tr})	0.5 A	Standard	IEC 62052-31
Starting current	20 mA	Mechanical environment	M1
Power consumption at I _{ref}	< 0.1 VA	Electromagnetic environment	E2
Nominal voltage (U _n)	3x230 V/400 V (-20 %...+15 %)	Humidity	non condensing
Power consumption per phase at U _n	< 8 VA	Installation	DIN Rail 35 mm
Nominal frequency (f _n)	50 Hz and 60 Hz	Dimensions (W x H x D)	53.6 mm x 84 mm x 69.4 mm
Minimum measuring time	10 s	Colour	RAL 7035
Accuracy			
Active energy	class 1 EN 62053-21 class B EN 50470-3 ±1.5 % from I _{min} to I _{tr} ±1 % from I _{tr} to I _{max}		
Reactive, Apparent energy	class 2 EN 62053-23 ±2.5 % from I _{min} to I _{tr} ±2 % from I _{tr} to I _{max}		
Voltage	±1 % of measured value		
Current	±1 % of I _{ref} from I _{st} to I _{ref} ±1 % of measured value from I _{ref} to I _{max}		
Active Power	±1 % of nominal power (U _n *I _{ref}) from I _{st} to I _{ref} ±1 % of measured value from I _{ref} to I _{max}		
Reactive, Apparent power	±2 % of nominal power from I _{st} to I _{ref} ±2 % of measured value from I _{ref} to I _{max}		
Frequency	±0.5 % of measured value		
LCD			
Type	LCD		
Number of energy display rows	2		
Number of digits:	8 (6+2)		
Height of digits:	4.52 mm		
LED			
Colour	red		
Pulse rate	1000 imp/kWh		
LED on	no load indication		

Single Phase Modular Energy Meter 40A

Single phase modular Energy Meter, direct metering 40A:



- // Single-phase direct connected DIN-rail mounting meter
- // 1 DIN module width
- // Class 1 for active energy and class 2 for reactive energy
- // Maximum current 40 A (I_{max})
- // Communication: s0 (pulse output)

1MEM40-BPO energy meters for measurement in a single-phase electrical network. Can be used in residential, industrial and utility applications. Meters measure energy directly in 2-wire networks according to the principle of fast sampling of voltage and current signals.

Features:

- // Single-phase direct connected DIN-rail mounting meter.
- // Class 1 for active energy according to EN 62053-21
- // Class 2 for reactive energy according to IEC 62053-23.
- // Bidirectional energy measurement (imp./exp.).
- // Maximum current 40 A (I_{max}).
- // Basic current 5 A (I_b).
- // 230 V rated system voltage input (U_n).
- // Voltage operating range (-20 % ... +15 %) U_n.
- // Reference frequencies 50 Hz and 60 Hz.
- // Power consumption voltage circuit < 10 VA at U_n.
- // Power consumption current circuit < 0.1 VA at I_b.
- // Temperature range climatic condition as indoor meter according IEC 62052-11.
- // Custom LCD display with 7 digits (100 Wh resolution).
- // Multifunctional front red LED.
- // LED constant 1000 imp/kWh.
- // Backlight for better visibility.
- // Special functions added for easier integration into monitoring and control systems.
- // Measurements of:
 - // power (active/reactive/apparent),
 - // energy (active/reactive/apparent),
 - // voltage,
 - // current,
 - // frequency,
 - // power factor,
 - // power angle,
 - // active tariff (option),
 - // THD of voltage,
 - // THD of current.
- // Pulse output according to IEC 62053-31.
- // DIN-rail mounting according to EN 60715.
- // 55°C ambient operation temperature.
- // Sealable terminal cover.
- // 1 DIN module width.

Modular Energy Counter 1MEM40

Type	Description	Code		
1MEM40-BPO	Single phase, 40A, S0 (Pulse output)	004657205	84	1/100

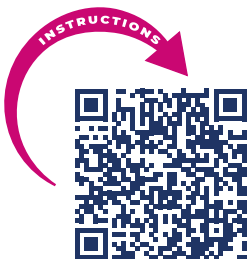

Technical Data

Rail mounting	DIN EN60715	Pulse output	
Main inputs		Pulse rate	1000 imp/kWh
Contacts capacity - Flexible (Rigid)	1.5 mm ² ... 10 mm ²	Pulse duration	32 ms ± 2 ms
Connection screws	M3.5	Rated voltage DC	27 V max
Max torque	0.8 Nm (PZ2)	Switched current	27 mA max
Length or removed isolation	10 mm	Standard	IEC 62053-31 (A&B)
Auxiliary contacts		Ambient conditions and Safety	
Contact capacity	0.05 mm ² ... 1 (2.5) mm ²	Temperature and climatic condition	EN 62052 11
Screws	M3	Dust/water protection	IP50
Max torque	0.6 Nm	Operating temp. range	-25°C... +55°C
Length or removed isolation	8 mm	Storage temp. range	-30 °C... +70°C
Measuring input		Enclosure material	self-extinguish complying UL94 V
Type	Single phase (1b)	Indoor meter	yes
Reference (nominal) current (I _{ref})	5 A	Degree of pollution	2
Maximum current (I _{max})	40 A	Protection class	II
Minimum current (I _{min})	0.25 A	Installation category	300 V _{max} cat.III
Transitional current (I _{tr})	0.5 A	Standard	IEC 62052-31
Starting current	20 mA	Mechanical environment	M1
Power consumption at I _{ref}	< 0.1 VA	Electromagnetic environment	E2
Nominal voltage (U _n)	3x230 V (-20 %...+15 %)	Humidity	non condensing
Power consumption per phase at U _n	< 10 VA	Installation	DIN Rail 35 mm
Nominal frequency (f _n)	50 Hz and 60 Hz	Dimensions (W x H x D)	17,5 mm x 90,7 mm x 68,2 mm
Minimum measuring time	10 s	Colour	RAL 7035
Accuracy			EU Directive on Measuring Instruments 2014/32/EU. EU Directive on EMC 2014/30/EU. EU Directive on Low Voltage 2014/35/EU. EC Directive WEEE 2002/96/EC. EU Directive RED 2014/53/EU
Active energy	class 1 EN 62053-21 class B EN 50470-3 ±1.5 % from I _{min} to I _{tr} ±1 % from I _{tr} to I _{max}	EU Directives	
Reactive, Apparent energy	class 2 EN 62053-23 ±2.5 % from I _{min} to I _{tr} ±2 % from I _{tr} to I _{max}		
Voltage	±1 % of measured value		
Current	±1 % of I _{ref} from I _{st} to I _{ref} ±1 % of measured value from I _{ref} to I _{max}		
Active Power	±1 % of nominal power (U _n *I _{ref}) from I _{st} to I _{ref} ±1 % of measured value from I _{ref} to I _{max}		
Reactive, Apparent power	±2 % of nominal power from I _{st} to I _{ref} ±2 % of measured value from I _{ref} to I _{max}		
Frequency	±0.1 % of measured value		
LCD			
Number of digits:	7		
Height of digits:	5.5 mm		
LED			
Colour	red		
Pulse rate	1000 imp/kWh		
LED on	no load indication		

ETIMETER

Metering Current Transformers

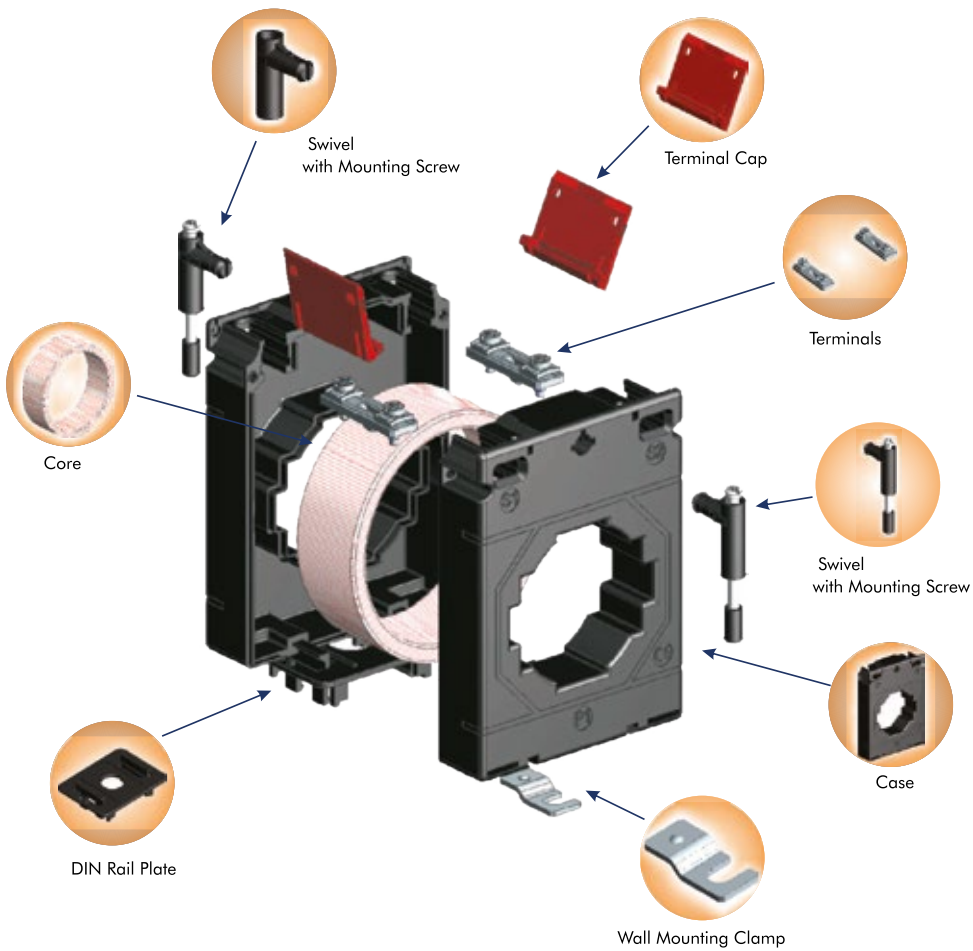

Applications

Balanced systems: network analyzers, automatic power factor correction systems (PFCs)



Features

Connection terminal with cover (IP20) for universal connection, no fork needed

Bus bar or din rail mounting, included complete mounting set

Standards: 61869-2

Metering Current transformers - Single Phase

Type	Code No.	Primary/ secondary	Power [VA]	Accuracy class	 g	
CTR-30 50/5 CL.1	004805500	50/5	1,25	1	365	1/63
CTR-30 100/5 CL.0,5	004805504	100/5	1,5	0,5	365	1/63
CTR-30 150/5 CL.0,5	004805507	150/5	3,75	0,5	365	1/63
CTR-30 200/5 CL.0,5	004805508	200/5	5	0,5	365	1/63
CTR-30 250/5 CL.0,5	004805509	250/5	5	0,5	365	1/63
CTR-30 300/5 CL.0,5	004805510	300/5	5	0,5	365	1/63
CTR-30 400/5 CL.0,5	004805511	400/5	7,5	0,5	365	1/63
CTR-30 500/5 CL.0,5	004805512	500/5	10	0,5	365	1/63
CTR-30 600/5 CL.0,5	004805513	600/5	15	0,5	365	1/63



Technical data

Applicable Standard	IEC 61869, IEC/EN 60044-1, BS 3938
Case	10% glass filled polycarbonate, flame retardant grades classified UL 94V-0
Insulation Class	E (120°C max.)
System voltage	720V max.
Test Voltage	
For Ring (Window) type CT	4kV 50 Hz / 1 min.
For Wound type er	3KV 50Hz / 1 min.
Operating frequency	50Hz or 60Hz Rated Primary rating:- 1A to 7500A
Rated secondary output	5A standard (1A on request)
Ambient temperature	-20°C ... +45°C
Storage temperature	-50°C ... +80°C
Thermal short circuit current (I _{th})	60 x I _n for Busbar type
Dynamic short circuit current (I _{dyn})	2.5 x I _n



Wall mounting



Busbar mounting

