



ASTI

Miniature circuit breakers and residual current devices

Miniature circuit breakers	2
Residual current circuit breakers	54
Residual current circuit breakers with integral overcurrent protection	81



f @ in v
/etigroup

ETI
SWITCH TO
A SAFE FUTURE

ASTI

Miniature Circuit Breakers ETIMAT - MCBs

Miniature circuit breakers ETIMAT 6

- /"ON/OFF" mark on the switch button



- /" Sealing possibility in ON or OFF position



- /" Option of mounting auxiliary devices (auxiliary switch, shunt trip)



- /" Trip-free mechanism ensures that MCB trips even if the toggle is held in ON position
- /" Separate indication of contacts' real state (independent of the toggle position) ensures additional user safety
- /" green flag: contacts open, red flag: contacts closed



- /" Every product is marked with EAN Code

- /" New method of mounting on the DIN rail and simple replacement



- /" Better protection of terminals against touching the parts under voltage



- /" All the MCBs also offer enough space for marking labels.



- /" Double connection possibility - all MCBs can be simultaneously connected to busbar and conductor, both from above and below

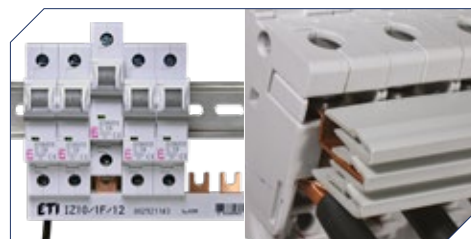

Electromagnetic release (protection against short-circuit currents)

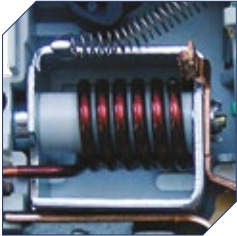

To ensure a high switching capacity, the "quick switching" function is implemented in the mechanism

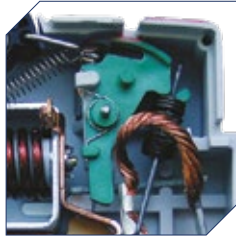

Silver plated power contacts (low transient resistance, increased electrical capacity)



Reduced number of welding points, all current-conducting parts are made of copper (low transient resistance)

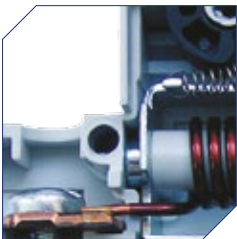

Combined reset mechanism (off time ~ 2.5ms)

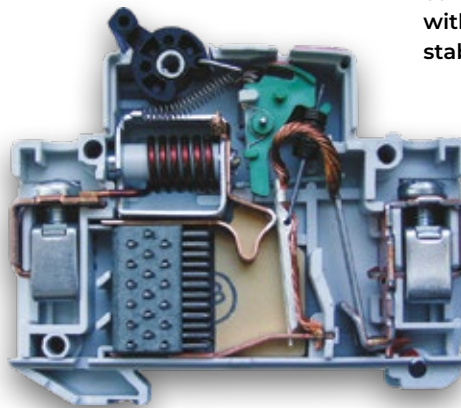

The setting of the thermal release is controlled by fixing the adjusting screw with the help of paint (maintaining the stability of the parameters)

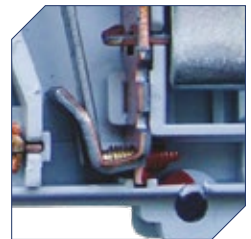

Arc chamber consists of 12 plates (quick and reliable arc extinguishing)

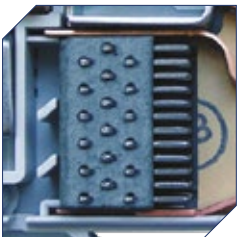

Ceramic insulation plate (reliable protection against thermal loads)

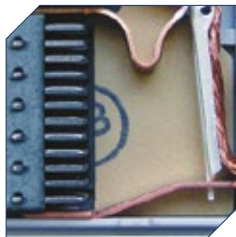

Thermal release (bimetallic plate - overload protection)

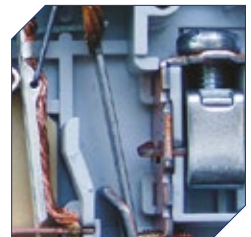

Miniature circuit breaker ETIMAT 6

Rated short-circuit capacity
6 kA

Rated current
0,5 - 63 A

Tripping characteristic
B, C, D

Technical data

Rated voltage	230/400 V AC, max. 60 V DC / pole
Rated current	B:1-63A, C:0.5-63A, D:0.5-63A
Rated frequency	50/60 Hz
Rated short-circuit capacity	6 kA
Back-up fuse	100A gG
Energy limiting class	3; B, C
Tripping characteristic	B, C, D
Terminals	1 – 25 mm ² , max. 3 Nm
Terminal screw	M5 (Pozidrive PZ2)
Build-in width	17,6 mm/pol
Mounting on the rail	EN 60715 (EN 50022)
Busbar Thickness	0,8-2mm
Mounting position	any
Sealing possibility	ON / OFF
Electrical endurance (ops)	8.000
Mechanical endurance (ops)	20.000
Overvoltage category	III
Resistance to vibrations acc. to IEC 60068-2-7	5g (10,60 & 500Hz)
Standards	IEC 60898, EN 60898, IEC 60947-2

Tripping characteristics

Characteristic	Test current	Tripping time	Result
B, C, D	1,13 I _n	t ≥ 3600 s	No tripping
B, C, D	1,45 I _n	t < 3600 s	Tripping
B, C, D	2,55 I _n	1s < t < 60 s	Tripping
B	3,00 I _n	t ≤ 0,1 s	No tripping
C	5,00 I _n	t ≤ 0,1 s	No tripping
D	10,00 I _n	t ≤ 0,1 s	No tripping
B	5,00 I _n	t < 0,1 s	Tripping
C	10,00 I _n	t < 0,1 s	Tripping
D	20,00 I _n	t < 0,1 s	Tripping

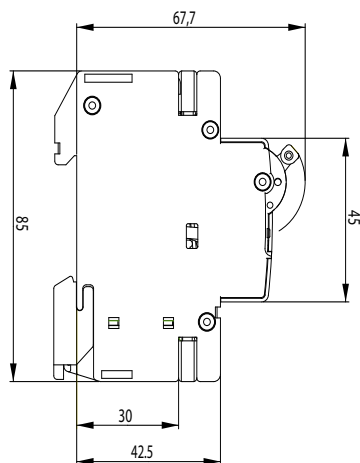
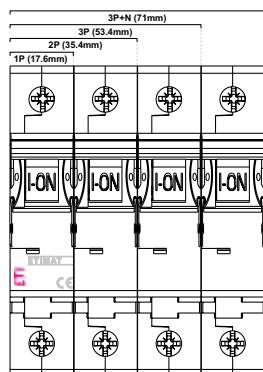
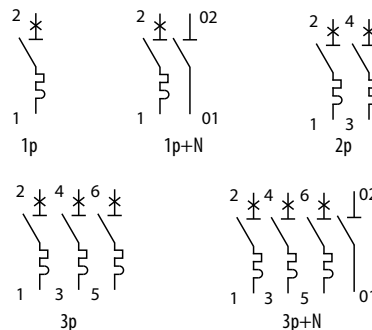

3-pole

I_n [A]	U_n [V]	Type B	Code No.	Type C	Code No.	Type D	Code No.	g	Box
0,5	400	/	/	ETIMAT 6 3p C 0,5	002145501	ETIMAT 6 3p D 0,5	002164501	354	4/36
1		ETIMAT 6 3p B 1	002115509	ETIMAT 6 3p C 1	002145504	ETIMAT 6 3p D 1	002164504	354	4/36
1,6		/	/	ETIMAT 6 3p C 1,6	002145507	ETIMAT 6 3p D 1,6	002164507	354	4/36
2		ETIMAT 6 3p B 2	002115510	ETIMAT 6 3p C 2	002145508	ETIMAT 6 3p D 2	002164508	354	4/36
3		/	/	ETIMAT 6 3p C 3	002145509	/	/	354	4/36
4		ETIMAT 6 3p B 4	002115511	ETIMAT 6 3p C 4	002145510	ETIMAT 6 3p D 4	002164510	354	4/36
6		ETIMAT 6 3p B 6	002115512	ETIMAT 6 3p C 6	002145512	ETIMAT 6 3p D 6	002164512	345	4/36
10		ETIMAT 6 3p B 10	002115514	ETIMAT 6 3p C 10	002145514	ETIMAT 6 3p D 10	002164514	345	4/36
13		ETIMAT 6 3p B 13	002115515	ETIMAT 6 3p C 13	002145515	ETIMAT 6 3p D 13	002164515	345	4/36
16		ETIMAT 6 3p B 16	002115516	ETIMAT 6 3p C 16	002145516	ETIMAT 6 3p D 16	002164516	345	4/36
20		ETIMAT 6 3p B 20	002115517	ETIMAT 6 3p C 20	002145517	ETIMAT 6 3p D 20	002164517	345	4/36
25		ETIMAT 6 3p B 25	002115518	ETIMAT 6 3p C 25	002145518	ETIMAT 6 3p D 25	002164518	345	4/36
32		ETIMAT 6 3p B 32	002115519	ETIMAT 6 3p C 32	002145519	ETIMAT 6 3p D 32	002164519	345	4/36
40		ETIMAT 6 3p B 40	002115520	ETIMAT 6 3p C 40	002145520	ETIMAT 6 3p D 40	002164520	345	4/36
50		ETIMAT 6 3p B 50	002115521	ETIMAT 6 3p C 50	002145521	ETIMAT 6 3p D 50	002164521	372	4/36
63		ETIMAT 6 3p B 63	002115522	ETIMAT 6 3p C 63	002145522	ETIMAT 6 3p D 63	002164522	372	4/36

**3-pole + N**

I_n [A]	U_n [V]	Type B	Code No.	Type C	Code No.	Type D	Code No.	g	Box
0,5	400	/	/	ETIMAT 6 3p+N C 0,5	002146501	ETIMAT 6 3p+N D 0,5	002165501	469	3/27
1		ETIMAT 6 3p+N B 1	002116509	ETIMAT 6 3p+N C 1	002146504	ETIMAT 6 3p+N D 1	002165504	469	3/27
1,6		/	/	ETIMAT 6 3p+N C 1,6	002146507	ETIMAT 6 3p+N D 1,6	002165507	469	3/27
2		ETIMAT 6 3p+N B 2	002116510	ETIMAT 6 3p+N C 2	002146508	ETIMAT 6 3p+N D 2	002165508	469	3/27
3		/	/	ETIMAT 6 3p+N C 3	002146509	/	/	469	3/27
4		ETIMAT 6 3p+N B 4	002116511	ETIMAT 6 3p+N C 4	002146510	ETIMAT 6 3p+N D 4	002165510	469	3/27
6		ETIMAT 6 3p+N B 6	002116512	ETIMAT 6 3p+N C 6	002146512	ETIMAT 6 3p+N D 6	002165512	459	3/27
10		ETIMAT 6 3p+N B 10	002116514	ETIMAT 6 3p+N C 10	002146514	ETIMAT 6 3p+N D 10	002165514	459	3/27
13		ETIMAT 6 3p+N B 13	002116515	ETIMAT 6 3p+N C 13	002146515	ETIMAT 6 3p+N D 13	002165515	459	3/27
16		ETIMAT 6 3p+N B 16	002116516	ETIMAT 6 3p+N C 16	002146516	ETIMAT 6 3p+N D 16	002165516	459	3/27
20		ETIMAT 6 3p+N B 20	002116517	ETIMAT 6 3p+N C 20	002146517	ETIMAT 6 3p+N D 20	002165517	459	3/27
25		ETIMAT 6 3p+N B 25	002116518	ETIMAT 6 3p+N C 25	002146518	ETIMAT 6 3p+N D 25	002165518	459	3/27
32		ETIMAT 6 3p+N B 32	002116519	ETIMAT 6 3p+N C 32	002146519	ETIMAT 6 3p+N D 32	002165519	459	3/27
40		ETIMAT 6 3p+N B 40	002116520	ETIMAT 6 3p+N C 40	002146520	ETIMAT 6 3p+N D 40	002165520	459	3/27
50		ETIMAT 6 3p+N B 50	002116521	ETIMAT 6 3p+N C 50	002146521	ETIMAT 6 3p+N D 50	002165521	493	3/27
63		ETIMAT 6 3p+N B 63	002116522	ETIMAT 6 3p+N C 63	002146522	ETIMAT 6 3p+N D 63	002165522	493	3/27



The circuit breakers type ETIMAT 6 / 3-pole + N are suitable for use as 4-pole circuit breakers

Effect of the ambient temperature on the tripping characteristic of ETIMAT 6

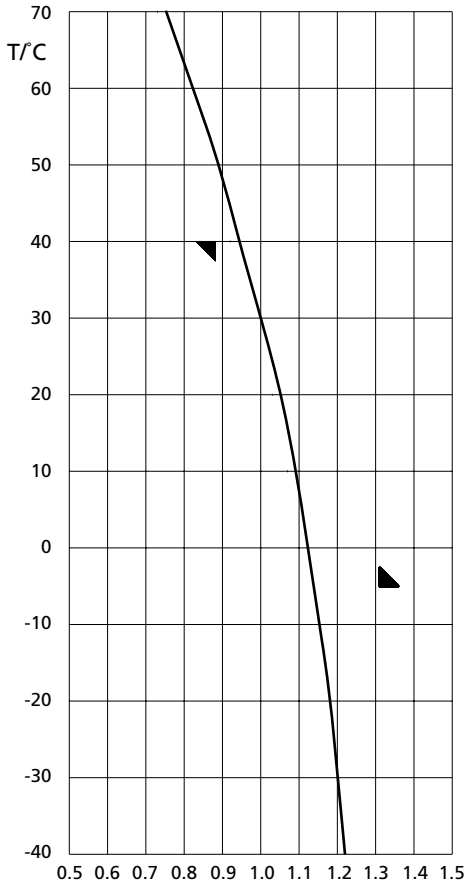

I_n [A]	Ambient temperature $T/^{\circ}\text{C}$											
	-40	-30	-20	-10	0	10	20	30	40	50	60	70
0,5	0,61	0,6	0,59	0,57	0,56	0,54	0,52	0,5	0,47	0,44	0,41	0,38
1	1,22	1,2	1,18	1,15	1,12	1,09	1,05	1	0,94	0,88	0,82	0,75
1,6	1,95	1,92	1,89	1,84	1,79	1,74	1,68	1,6	1,51	1,42	1,32	1,2
2	2,44	2,4	2,36	2,30	2,24	2,18	2,1	2	1,88	1,77	1,65	1,5
4	4,88	4,8	4,72	4,61	4,49	4,36	4,20	4	3,77	3,55	3,29	3
6	7,32	7,2	7,09	6,91	6,73	6,54	6,31	6	5,66	5,33	4,94	4,5
10	12,2	12	11,8	11,5	11,2	10,9	10,5	10	9,44	8,89	8,23	7,5
13	15,9	15,6	15,4	14,9	14,5	14,1	13,6	13	12,2	11,5	10,7	9,75
16	19,5	19,2	18,9	18,4	17,9	17,4	16,8	16	15,1	14,2	13,2	12
20	24,4	24	23,6	23	22,4	21,8	21	20	18,8	17,7	16,5	15
25	30,5	30	29,5	28,8	28	27,2	26,3	25	23,6	22,2	20,6	18,8
32	39	38,4	37,8	36,9	35,9	34,9	33,6	32	30,2	28,4	26,3	24
40	48,8	48	47,8	46,1	44,9	43,6	42	40	37,7	35,5	32,9	30
50	61	60	59,1	57,6	56,1	54,5	52,6	50	47,2	44,4	41,2	37,5
63	76,9	75,6	74,4	72,6	70,7	68,7	66,2	63	59,4	56	51,9	47,3

Correction factor is valid for current with times over 30 s

$$k = \frac{I(x^{\circ}\text{C})}{I(30^{\circ}\text{C})}$$

$I(x^{\circ}\text{C})$ - test current at x ambient temperature
 $I(30^{\circ}\text{C})$ - test current at 30°C ambient temperature

Resistance and power dissipation

characteristic	I_n [A]	R/pole [mΩ]	P/pole [w]
C, D	0,5	4500	1,12
	1	1800	1,80
	1,6	450	1,15
	2	280	1,08
	4	110	1,70
B, C, D	6	29	1,08
	10	13	1,30
	13	11,6	2,00
	16	9,0	2,30
	20	5,3	2,00
	25	4,1	2,50
	32	2,6	2,70
	40	1,96	3,20
	50	1,5	4,00
	63	1,15	4,80

Selectivity

ETIMAT	gG NV											
	20	25	32	35	40	50	63	80	100	125	160	
B 6	0,5	0,78	1,2	1,4	1,7	2,4	4,6	6,0	6,0	6,0	6,0	
B 10/13	0,45	0,65	1,1	1,3	1,6	2,2	4,0	6,0	6,0	6,0	6,0	
B 16		0,55	1,0	1,2	1,5	2,0	3,6	5,5	6,0	6,0	6,0	
B 20			0,85	1,2	1,5	1,8	3,1	4,6	6,0	6,0	6,0	
B 25				1,1	1,4	1,7	2,9	4,0	6,0	6,0	6,0	
B 32					1,3	1,6	2,5	3,4	5,5	6,0	6,0	
B 40						1,5	2,2	3,1	4,9	6,0	6,0	
B 50							2,1	2,9	4,0	6,0	6,0	
B 63								2,5	3,3	5,1	6,0	

ETIMAT	gG NV											
	20	25	32	35	40	50	63	80	100	125	160	
C,D 6	0,52	0,82	1,3	1,5	2,0	2,7	5,1	6,0	6,0	6,0	6,0	
C,D 10/13	0,47	0,70	1,1	1,4	1,8	2,3	4,0	6,0	6,0	6,0	6,0	
C,D 16		0,61	0,92	1,2	1,5	1,9	3,2	5,0	6,0	6,0	6,0	
C,D 20			0,90	1,1	1,4	1,7	2,9	4,2	6,0	6,0	6,0	
C,D 25				1,0	1,3	1,6	2,7	3,9	6,0	6,0	6,0	
C,D 32					1,2	1,5	2,3	3,4	5,2	6,0	6,0	
C,D 40						1,4	2,1	3,0	4,6	6,0	6,0	
C,D 50							2,0	2,7	3,8	6,0	6,0	
C,D 63								2,3	3,2	5,5	6,0	

Time current characteristics I/t at 50 and 60Hz, ETIMAT

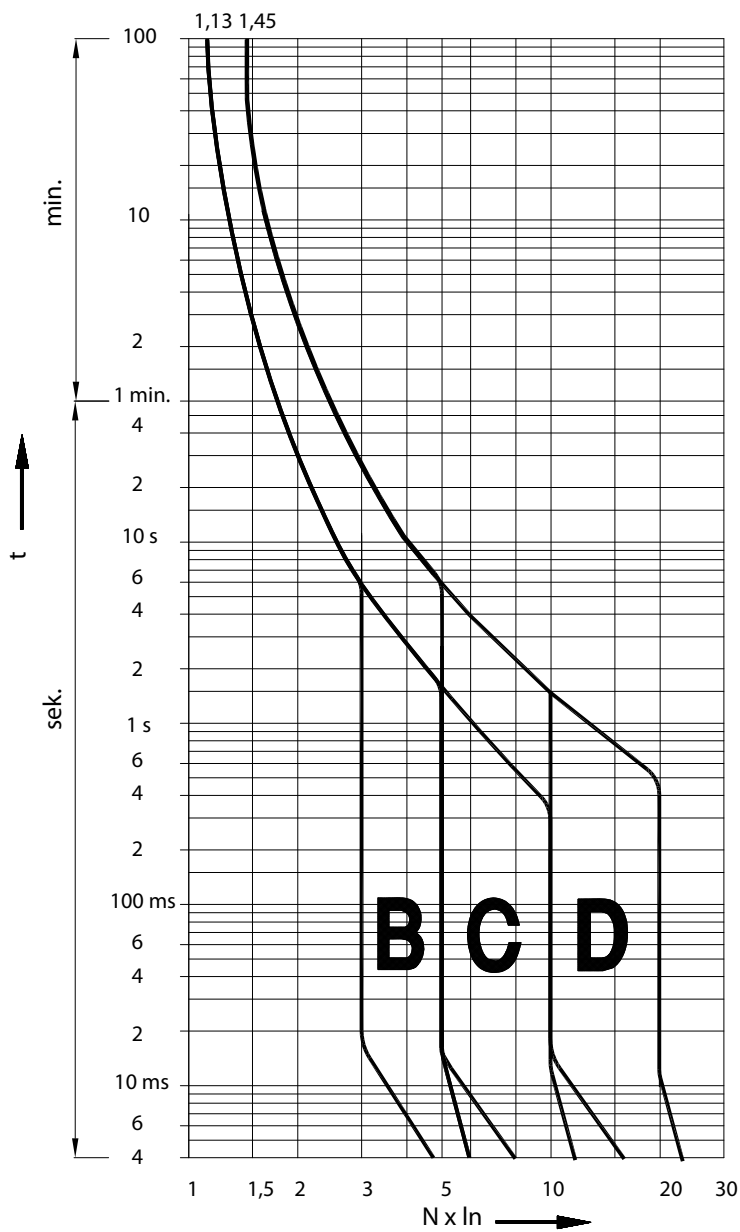

Conductor cross-section [mm ²]	Number of single conductors, rigid, single-wire CU conductor				
	1	2	3	4	5
1,5	✓	✓	✓	✓	✗
2,5	✓	✓	✓	✗	✗
4	✓	✓	✓	✗	✗
6	✓	✓	✗	✗	✗
10	✓	✓	✗	✗	✗
16	✓	✗	✗	✗	✗
25	✓	✗	✗	✗	✗

Remark: When you use more than 2 cables you have to be careful how those cables are inserted to ensure proper pressure on each cable

Conductor cross-section [mm ²]	Number of single conductors, flexible Cu conductors with cable ferrule					
	1	2	3	4	5	6
1,5	✓	✓	✓	✓	✓	✓
2,5	✓	✓	✓	✓	✓	✓
4	✓	✓	✓	✓	✓	✓
6	✓	✓	✓	✗	✗	✗
10	✓	✓	✗	✗	✗	✗
16	✓	✗	✗	✗	✗	✗
25	✓	✗	✗	✗	✗	✗

Combination of rigid single-wire and flexible multi-wire Cu conductors is not allowed

Melting energy characteristics I²t ETIMAT

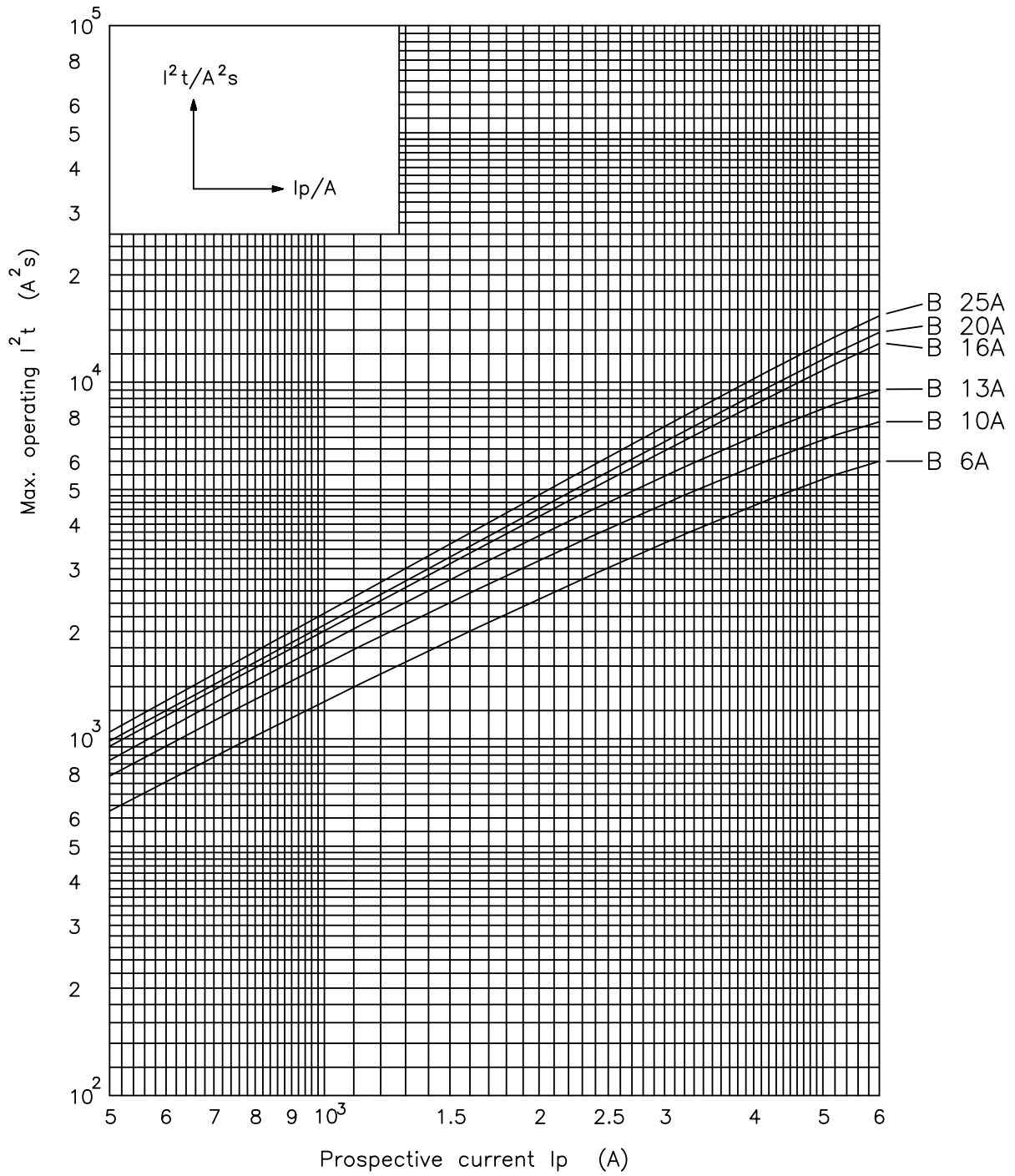

Melting energy characteristics I²t ETIMAT

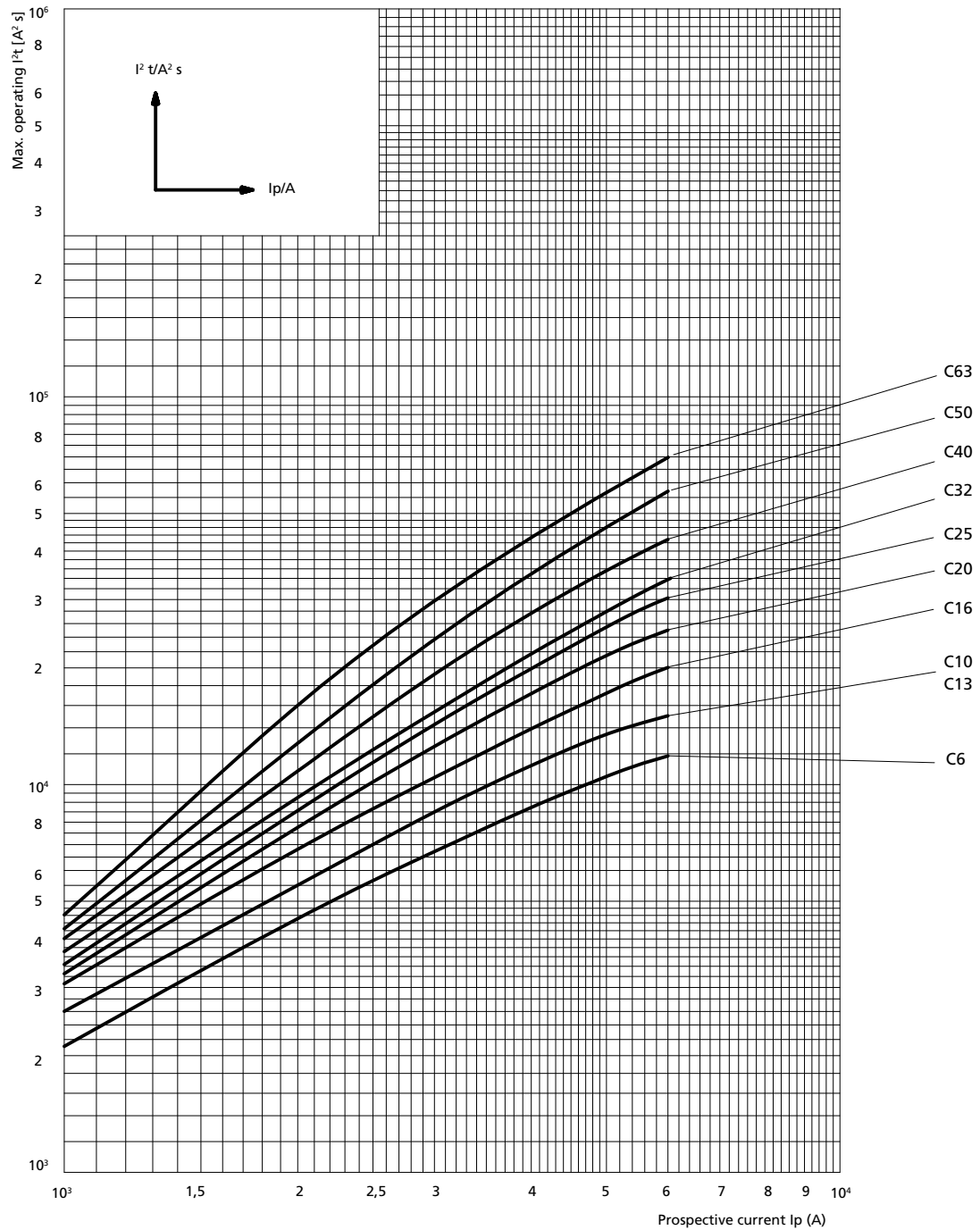

Miniature circuit breaker ETIMAT 1N

Rated short-circuit capacity
6 kA

Rated current
6 - 32 A

Tripping characteristic
B, C

Description

Miniature circuit breaker ETIMAT 1N is a device with protected line pole and switched neutral pole.

Advantages:

- // 1-pole+N in single housing
- // Sealing possibility
- // Indication of contacts' state
- // New method of mounting on the DIN rail and simple replacement

Technical data

Rated voltage U_n	230 V AC
Rated current I_n	6-32 A
Min. operating voltage	12V AC/DC
Max operating voltage	240V AC
Rated frequency f_n	50/60Hz
Rated short-circuit capacity	6.000 A
Back-up fuse	100 A gG
Tripping characteristics	B, C
Overvoltage category	III
Energy limiting class	3
Terminals	1-10mm ² , max. 1,5Nm
Terminal screw	M4 (Pozidrive PZ2)
Ambient temperature	-40°C ... +70°C
Storage temperature	-60°C ... +70°C
Build-in width	18mm
Mounting position	any
Supply possibility	top or bottom
Resistance to vibrations acc. to IEC 60068-2-7	5g (10,60 & 500Hz)
Standard	IEC 60898, EN 60898

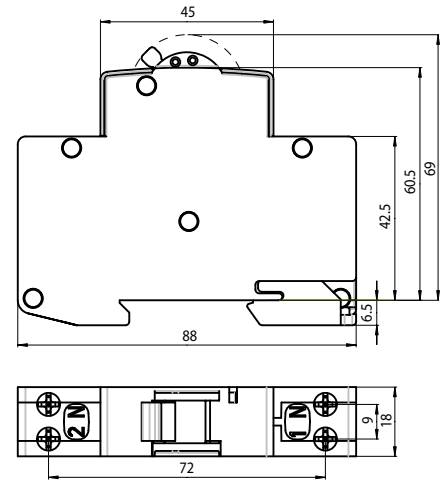

ETIMAT 1N

I_n [A]	Type B	Code No.	Type C	Code No.		
6	ETIMAT 1N B 6A	002191101	ETIMAT 1N C 6A	002191121	118	12/108
10	ETIMAT 1N B 10A	002191102	ETIMAT 1N C 10A	002191122	118	12/108
13	ETIMAT 1N B 13A	002191103	ETIMAT 1N C 13A	002191123	118	12/108
16	ETIMAT 1N B 16A	002191104	ETIMAT 1N C 16A	002191124	118	12/108
20	ETIMAT 1N B 20A	002191105	ETIMAT 1N C 20A	002191125	118	12/108
25	ETIMAT 1N B 25A	002191106	ETIMAT 1N C 25A	002191126	118	12/108
32	ETIMAT 1N B 32A	002191107	ETIMAT 1N C 32A	002191127	118	12/108



ASTI / Miniature Circuit Breakers

Conductor cross-section [mm ²]	Number of single conductors, rigid, single-wire CU conductor					
	1	2	3	4	5	6
1,5	✓	✓	✓	✓	✓	✓
2,5	✓	✓	✓	✓	✓	✗
4	✓	✓	✓	✗	✗	✗
6	✓	✓	✗	✗	✗	✗
10	✓	✗	✗	✗	✗	✗

Remark: When you use more than 2 cables you have to be careful how those cables are inserted to ensure proper pressure on each cable

Conductor cross-section [mm ²]	Number of single conductors, flexible Cu conductors with cable ferrule					
	1	2	3	4	5	6
1,5	✓	✓	✓	✗	✗	✗
2,5	✓	✓	✗	✗	✗	✗
4	✓	✓	✗	✗	✗	✗
6	✓	✗	✗	✗	✗	✗
10	✓	✗	✗	✗	✗	✗

Combination of rigid single-wire and flexible multi-wire Cu conductors is not allowed

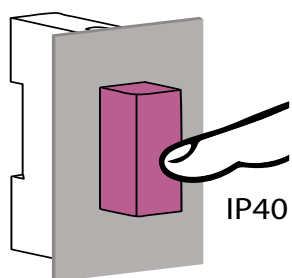
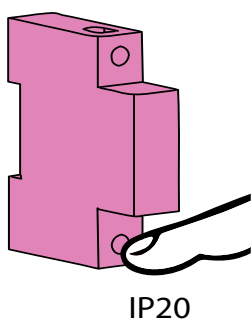
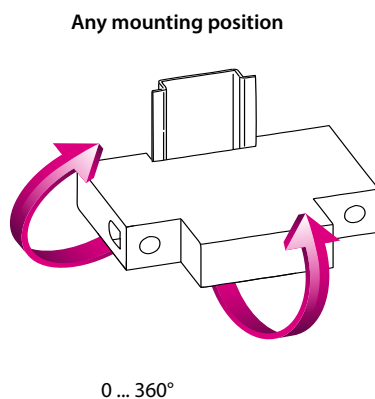
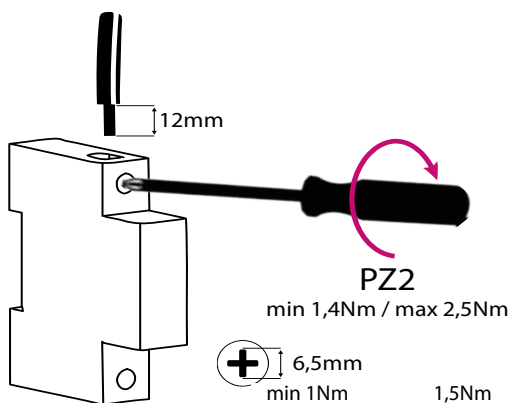

Accessories for ETIMAT 6

PS ETIMAT is an auxiliary switch used for remote signalling of the MCB to which it is fixed. PS ETIMAT may also be fixed later of the state. Clamps are safe to touch. External dimensions comply with MCB, built-in width is 0,5 module (9 mm). During fitting, the MCB must be switched off.



Technical data

Rated current	6A (230V AC), 1A (110V DC), 0,5A (220V DC)
Terminal	1-4mm ² , max 0,5Nm
Terminal screw	M3 (PH1)
Contact	1 xb-contact (NC) 1 xa-contact (NO)
Conditional short-circuit current	1 kA with fuse-link 20 A
Mounting position	any
Standard	EN-62019



PS ETIMAT 10

Auxiliary switch PS ETIMAT

Type	Code No.	contacts	 g	
PS ETIMAT 10 - MD	002159031	NO + NC	35	1/12
PS ETIMAT 10 - M	002159032	1 x NC	30	1/12
PS ETIMAT 10 - D	002159033	1 x NO	30	1/12

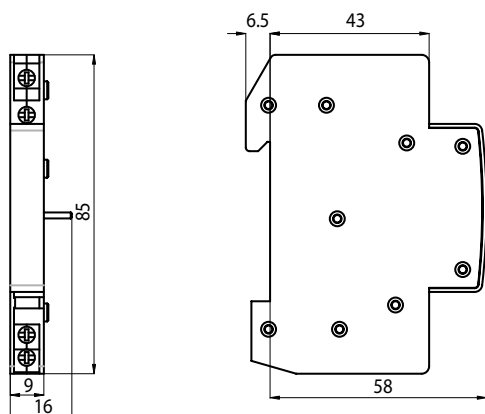
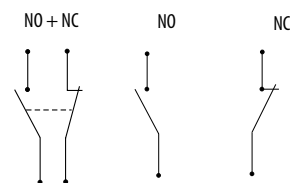

PS ETIMAT is an auxiliary switch only for ETIMAT 6.

DA ETIMAT shunt trip release is fixed to the right side of the miniature circuit breaker ETIMAT for remote release of the MCB. Dimensions correspond to those of MCB ETIMAT.

Technical data

Nominal voltage	24V AC/DC, 48V AC/DC, 230V AC/DC
Rated frequency	50/60Hz
Max. inrush current	3,6 A
Terminals	1-25mm ² , max 3Nm
Terminal Screw	M5 (Pozidrive PZ2)
Build-in width	18mm
Mounting position	any
Mounting on the rail	EN 60715 (EN 50022)

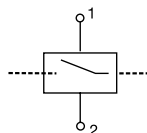

DA ETIMAT is a shunt trip release only for ETIMAT 6.





DA ETIMAT 10

Shunt trip release DA ETIMAT

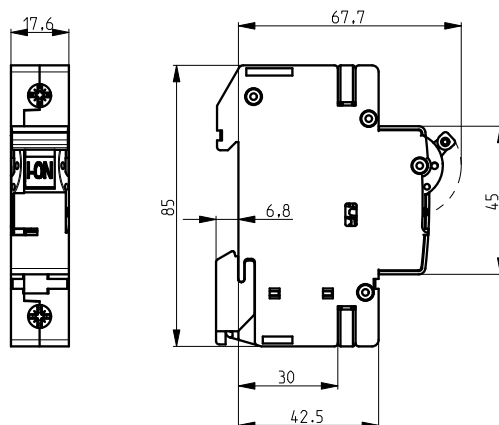
Type	Code No.	 g	
DA ETIMAT 10 230 V AC/DC	002159301	110	1/54
DA ETIMAT 10 48 V AC/DC	002159311	110	1/54
DA ETIMAT 10 24V AC/DC	002159312	110	1/54



Sealing piece ETIMAT

Code No.	 g	
002159041	2	12



Miniature circuit breakers ETIMAT P - NEW GENERATION



EXACT TRACEABILITY AND HIGHEST QUALITY CONTROL

Fully automated assembly line with 17 different tests and measurements during assembly process to ensure best functionality of each finished product. All important components are marked with a DMC code, containing individual test results and thus ensuring exact traceability and highest quality control of every MCB.

PATENTED CONSTRUCTION

The unique technology of combined thermomagnetic tripping unit with integrated thermal release prevents both manual tampering of the overload settings and material deterioration, ensuring precise and reliable overload tripping through the entire lifecycle of the MCB.

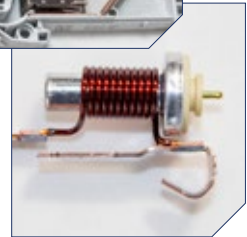
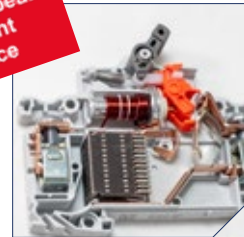

ALL DATA AVAILABLE WITH A SINGLE QR CODE SCAN

Every product has a QR code with a link to the product webpage with all relevant information, instruction manuals and other technical materials. All important technical data is printed on the front and side of the MCB. Every product is marked with EAN code.

SUPERIOR TECHNICAL FEATURES

reduced power dissipation
high electrical endurance: 20.000 operation cycles
operation in DC circuits with voltage up to 60V DC/pole
construction solutions protected by two international patents

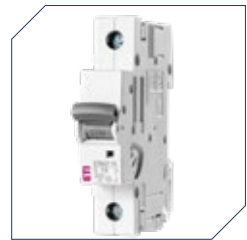

SPECIAL RESET VERSION

In the reset version, the toggle position clearly indicates the reason for tripping, preventing user mistakes and always making it clear whether the system turning off was intentional (manual) or the result of a fault in the electrical circuit.

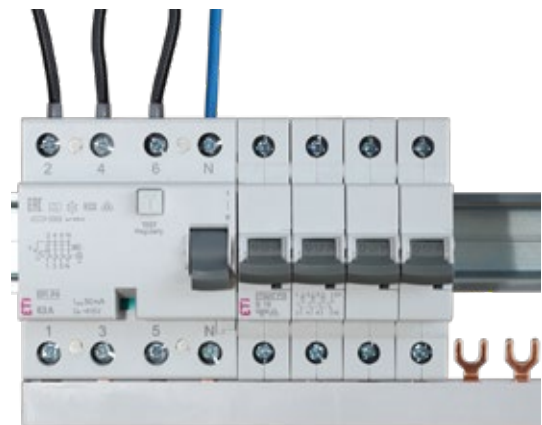
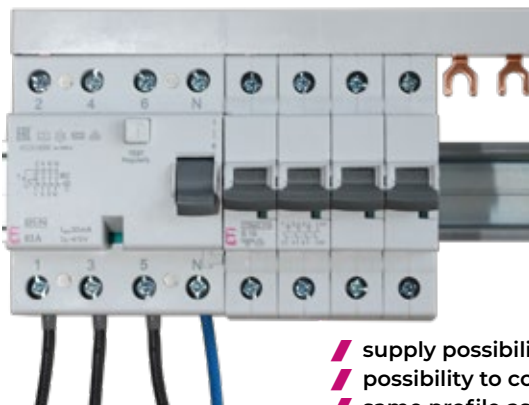

- /// supply possibility from top or bottom
- /// possibility to connect wires to terminals up to 25 mm²
- /// same profile as our other modular devices resulting in a coordinated and streamlined look to the installation

ASTI / Miniature Circuit Breakers

/// The possibility of mounting up to 3 auxiliary / signal switches



/// 4-module devices are equipped with sturdy pins, thus ensuring a rigid / smooth movement of the toggles. All the MCBs also offer enough space for marking labels.



/// Double connection possibility - all MCBs can be simultaneously connected to busbar and conductor, both from above and below



/// **NO WOBBLE™** technology new snapping unit enables easy, firm and secure DIN-rail mounting and replacement

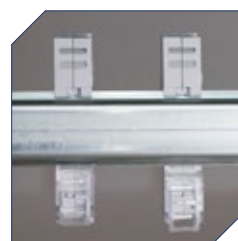

/// Trip-free mechanism ensures that MCB trips even if the toggle is held in ON position

/// Separate indication of contacts' real state (independent of the toggle position) ensures additional user safety

/// Green flag: contacts open, red flag: contacts closed



/// The possibility of mounting a terminal cover

/// The possibility of locking the handle in the "ON/OFF" position



/// Better protection of terminals against touching the parts under voltage



/// "ON/OFF" mark on the switch button



/// The possibility of sealing in "ON" or "OFF" position



Miniature circuit breaker ETIMAT P6

Rated short-circuit capacity
6 kA

Rated current
0,5 - 63 A

Tripping characteristic
B, C, D

Technical data

Rated voltage	240/415V AC; max 60V DC/pol
Min. operating voltage	12V AC/DC
Max operating voltage	250/440V AC
Rated current	0,5-63A
Rated frequency	50/60Hz
Rated insulation voltage	500V
Rated impulse withstand voltage	6kV (acc. to 60947-2)
Shock resistance	30g, min 2 shocks, t=13ms
Rated short-circuit capacity	6 kA
Energy limiting class	3; B,C
Tripping characteristic	B, C, D
Back-up fuse	100A gG
Index of protection	IP 20 (IP 40)
Terminals	1-25mm ² , min 1,4Nm / max 2,5Nm
Terminal screw	M5 (Pozidrive PZ2)
Mechanical endurance	20.000 op. cycles
Electrical endurance	20.000 op. cycles
Ambient temperature	max -40°C ... +70°C
Storage temperature	max -60°C ... +70°C
Supply possibility	top or bottom
Build-in width	18mm/pol
Insulating class	B
Overvoltage category	III
Pollution degree	2
Mounting on the rail	EN 60715
Mounting position	any
Sealing possibility	✓
Terminal cover	✓
Contact position indicator	✓
Locking device	✓
Resistance to vibrations acc. to IEC 60068-2-7	5g (10,60 & 500Hz)
Standards	IEC/EN 60898-1, IEC 60947-2

1p



1p+n

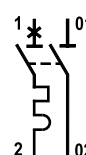

2p



3p

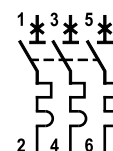

3p+n

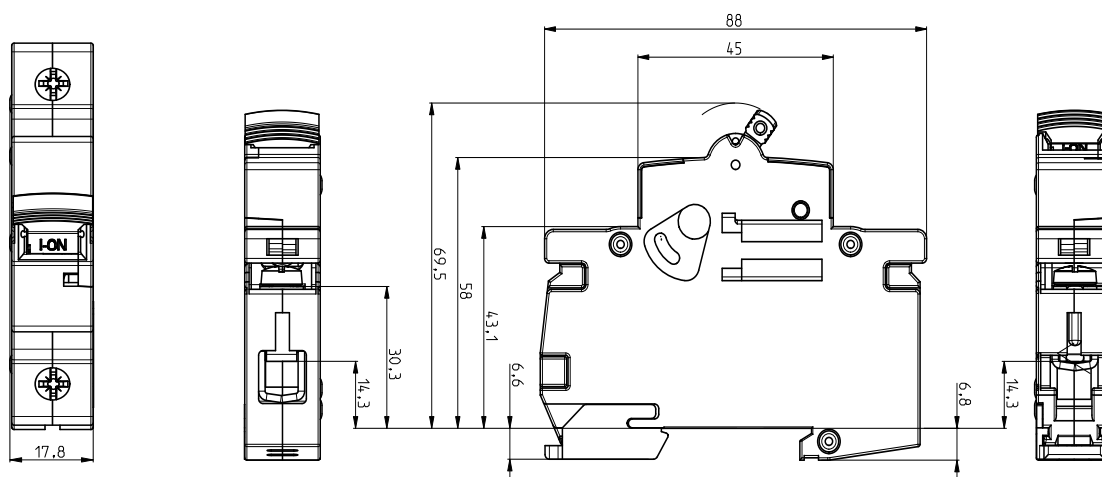
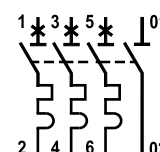

Tripping characteristics

Characteristic	Test current	Tripping time	Result
B, C, D	1,13 I _n	t ≥ 3600 s	No tripping
B, C, D	1,45 I _n	t < 3600 s	Tripping
B, C, D	2,55 I _n	1s < t < 60 s	Tripping
B	3,00 I _n	t ≤ 0,1 s	No tripping
C	5,00 I _n	t ≤ 0,1 s	No tripping
D	10,00 I _n	t ≤ 0,1 s	No tripping
B	5,00 I _n	t < 0,1 s	Tripping
C	10,00 I _n	t < 0,1 s	Tripping
D	20,00 I _n	t < 0,1 s	Tripping

1-pole

I _n [A]	U _n [V]	Type B	Code No. B	Type C	Code No. C	Type D	Code No. D	
0,5	/	/	/	ETIMAT P6 1p C 0,5	001900021	ETIMAT P6 1p D 0,5	001900041	12/108
1	240/415	ETIMAT P6 1p B 1	001900002	ETIMAT P6 1p C 1	001900022	ETIMAT P6 1p D 1	001900042	12/108
1,6		ETIMAT P6 1p B 1,6	001900003	ETIMAT P6 1p C 1,6	001900023	ETIMAT P6 1p D 1,6	001900043	12/108
2		ETIMAT P6 1p B 2	001900004	ETIMAT P6 1p C 2	001900024	ETIMAT P6 1p D 2	001900044	12/108
3		ETIMAT P6 1p B 3	001900005	ETIMAT P6 1p C 3	001900025	ETIMAT P6 1p D 3	001900045	12/108
4		ETIMAT P6 1p B 4	001900006	ETIMAT P6 1p C 4	001900026	ETIMAT P6 1p D 4	001900046	12/108
6		ETIMAT P6 1p B 6	001900007	ETIMAT P6 1p C 6	001900027	ETIMAT P6 1p D 6	001900047	12/108
10		ETIMAT P6 1p B 10	001900008	ETIMAT P6 1p C 10	001900028	ETIMAT P6 1p D 10	001900048	12/108
13		ETIMAT P6 1p B 13	001900009	ETIMAT P6 1p C 13	001900029	ETIMAT P6 1p D 13	001900049	12/108
16		ETIMAT P6 1p B 16	001900010	ETIMAT P6 1p C 16	001900030	ETIMAT P6 1p D 16	001900050	12/108
20		ETIMAT P6 1p B 20	001900011	ETIMAT P6 1p C 20	001900031	ETIMAT P6 1p D 20	001900051	12/108
25		ETIMAT P6 1p B 25	001900012	ETIMAT P6 1p C 25	001900032	ETIMAT P6 1p D 25	001900052	12/108
32		ETIMAT P6 1p B 32	001900013	ETIMAT P6 1p C 32	001900033	ETIMAT P6 1p D 32	001900053	12/108
40		ETIMAT P6 1p B 40	001900014	ETIMAT P6 1p C 40	001900034	ETIMAT P6 1p D 40	001900054	12/108
50		ETIMAT P6 1p B 50	001900015	ETIMAT P6 1p C 50	001900035	ETIMAT P6 1p D 50	001900055	12/108
63		ETIMAT P6 1p B 63	001900016	ETIMAT P6 1p C 63	001900036	/	/	12/108



1-pole + N

I _n [A]	U _n [V]	Type B	Code No. B	Type C	Code No. C	Type D	Code No. D	
0,5	/	/	/	ETIMAT P6 1p+N C 0,5	001900121	ETIMAT P6 1p+N D 0,5	001900141	6/54
1	240	ETIMAT P6 1p+N B 1	001900102	ETIMAT P6 1p+N C 1	001900122	ETIMAT P6 1p+N D 1	001900142	6/54
1,6		ETIMAT P6 1p+N B 1,6	001900103	ETIMAT P6 1p+N C 1,6	001900123	ETIMAT P6 1p+N D 1,6	001900143	6/54
2		ETIMAT P6 1p+N B 2	001900104	ETIMAT P6 1p+N C 2	001900124	ETIMAT P6 1p+N D 2	001900144	6/54
3		ETIMAT P6 1p+N B 3	001900105	ETIMAT P6 1p+N C 3	001900125	ETIMAT P6 1p+N D 3	001900145	6/54
4		ETIMAT P6 1p+N B 4	001900106	ETIMAT P6 1p+N C 4	001900126	ETIMAT P6 1p+N D 4	001900146	6/54
6		ETIMAT P6 1p+N B 6	001900107	ETIMAT P6 1p+N C 6	001900127	ETIMAT P6 1p+N D 6	001900147	6/54
10		ETIMAT P6 1p+N B 10	001900108	ETIMAT P6 1p+N C 10	001900128	ETIMAT P6 1p+N D 10	001900148	6/54
13		ETIMAT P6 1p+N B 13	001900109	ETIMAT P6 1p+N C 13	001900129	ETIMAT P6 1p+N D 13	001900149	6/54
16		ETIMAT P6 1p+N B 16	001900110	ETIMAT P6 1p+N C 16	001900130	ETIMAT P6 1p+N D 16	001900150	6/54
20		ETIMAT P6 1p+N B 20	001900111	ETIMAT P6 1p+N C 20	001900131	ETIMAT P6 1p+N D 20	001900151	6/54
25		ETIMAT P6 1p+N B 25	001900112	ETIMAT P6 1p+N C 25	001900132	ETIMAT P6 1p+N D 25	001900152	6/54
32		ETIMAT P6 1p+N B 32	001900113	ETIMAT P6 1p+N C 32	001900133	ETIMAT P6 1p+N D 32	001900153	6/54
40		ETIMAT P6 1p+N B 40	001900114	ETIMAT P6 1p+N C 40	001900134	ETIMAT P6 1p+N D 40	001900154	6/54
50		ETIMAT P6 1p+N B 50	001900115	ETIMAT P6 1p+N C 50	001900135	ETIMAT P6 1p+N D 50	001900155	6/54
63		ETIMAT P6 1p+N B 63	001900116	ETIMAT P6 1p+N C 63	001900136	/	/	6/54



2-pole

I_n [A]	U_n [V]	Type B	Code No. B	Type C	Code No. C	Type D	Code No. D	
0,5	/	/	/	ETIMAT P6 2p C 0,5	001900221	ETIMAT P6 2p D 0,5	001900241	6/54
1		ETIMAT P6 2p B 1	001900202	ETIMAT P6 2p C 1	001900222	ETIMAT P6 2p D 1	001900242	6/54
1,6		ETIMAT P6 2p B 1,6	001900203	ETIMAT P6 2p C 1,6	001900223	ETIMAT P6 2p D 1,6	001900243	6/54
2		ETIMAT P6 2p B 2	001900204	ETIMAT P6 2p C 2	001900224	ETIMAT P6 2p D 2	001900244	6/54
3		ETIMAT P6 2p B 3	001900205	ETIMAT P6 2p C 3	001900225	ETIMAT P6 2p D 3	001900245	6/54
4		ETIMAT P6 2p B 4	001900206	ETIMAT P6 2p C 4	001900226	ETIMAT P6 2p D 4	001900246	6/54
6		ETIMAT P6 2p B 6	001900207	ETIMAT P6 2p C 6	001900227	ETIMAT P6 2p D 6	001900247	6/54
10	415	ETIMAT P6 2p B 10	001900208	ETIMAT P6 2p C 10	001900228	ETIMAT P6 2p D 10	001900248	6/54
13		ETIMAT P6 2p B 13	001900209	ETIMAT P6 2p C 13	001900229	ETIMAT P6 2p D 13	001900249	6/54
16		ETIMAT P6 2p B 16	001900210	ETIMAT P6 2p C 16	001900230	ETIMAT P6 2p D 16	001900250	6/54
20		ETIMAT P6 2p B 20	001900211	ETIMAT P6 2p C 20	001900231	ETIMAT P6 2p D 20	001900251	6/54
25		ETIMAT P6 2p B 25	001900212	ETIMAT P6 2p C 25	001900232	ETIMAT P6 2p D 25	001900252	6/54
32		ETIMAT P6 2p B 32	001900213	ETIMAT P6 2p C 32	001900233	ETIMAT P6 2p D 32	001900253	6/54
40		ETIMAT P6 2p B 40	001900214	ETIMAT P6 2p C 40	001900234	ETIMAT P6 2p D 40	001900254	6/54
50		ETIMAT P6 2p B 50	001900215	ETIMAT P6 2p C 50	001900235	ETIMAT P6 2p D 50	001900255	6/54
63		ETIMAT P6 2p B 63	001900216	ETIMAT P6 2p C 63	001900236	/	/	6/54



3-pole

I_n [A]	U_n [V]	Type B	Code No. B	Type C	Code No. C	Type D	Code No. D	
0,5	/	/	/	ETIMAT P6 3p C 0,5	001900321	ETIMAT P6 3p D 0,5	001900341	4/36
1		ETIMAT P6 3p B 1	001900302	ETIMAT P6 3p C 1	001900322	ETIMAT P6 3p D 1	001900342	4/36
1,6		ETIMAT P6 3p B 1,6	001900303	ETIMAT P6 3p C 1,6	001900323	ETIMAT P6 3p D 1,6	001900343	4/36
2		ETIMAT P6 3p B 2	001900304	ETIMAT P6 3p C 2	001900324	ETIMAT P6 3p D 2	001900344	4/36
3		ETIMAT P6 3p B 3	001900305	ETIMAT P6 3p C 3	001900325	ETIMAT P6 3p D 3	001900345	4/36
4		ETIMAT P6 3p B 4	001900306	ETIMAT P6 3p C 4	001900326	ETIMAT P6 3p D 4	001900346	4/36
6		ETIMAT P6 3p B 6	001900307	ETIMAT P6 3p C 6	001900327	ETIMAT P6 3p D 6	001900347	4/36
10	415	ETIMAT P6 3p B 10	001900308	ETIMAT P6 3p C 10	001900328	ETIMAT P6 3p D 10	001900348	4/36
13		ETIMAT P6 3p B 13	001900309	ETIMAT P6 3p C 13	001900329	ETIMAT P6 3p D 13	001900349	4/36
16		ETIMAT P6 3p B 16	001900310	ETIMAT P6 3p C 16	001900330	ETIMAT P6 3p D 16	001900350	4/36
20		ETIMAT P6 3p B 20	001900311	ETIMAT P6 3p C 20	001900331	ETIMAT P6 3p D 20	001900351	4/36
25		ETIMAT P6 3p B 25	001900312	ETIMAT P6 3p C 25	001900332	ETIMAT P6 3p D 25	001900352	4/36
32		ETIMAT P6 3p B 32	001900313	ETIMAT P6 3p C 32	001900333	ETIMAT P6 3p D 32	001900353	4/36
40		ETIMAT P6 3p B 40	001900314	ETIMAT P6 3p C 40	001900334	ETIMAT P6 3p D 40	001900354	4/36
50		ETIMAT P6 3p B 50	001900315	ETIMAT P6 3p C 50	001900335	ETIMAT P6 3p D 50	001900355	4/36
63		ETIMAT P6 3p B 63	001900316	ETIMAT P6 3p C 63	001900336	/	/	4/36



3-pole + N

I_n [A]	U_n [V]	Type B	Code No. B	Type C	Code No. C	Type D	Code No. D	
0,5	/	/	/	ETIMAT P6 3p+N C 0,5	001900421	ETIMAT P6 3p+N D 0,5	001900441	3/27
1		ETIMAT P6 3p+N B 1	001900402	ETIMAT P6 3p+N C 1	001900422	ETIMAT P6 3p+N D 1	001900442	3/27
1,6		ETIMAT P6 3p+N B 1,6	001900403	ETIMAT P6 3p+N C 1,6	001900423	ETIMAT P6 3p+N D 1,6	001900443	3/27
2		ETIMAT P6 3p+N B 2	001900404	ETIMAT P6 3p+N C 2	001900424	ETIMAT P6 3p+N D 2	001900444	3/27
3		ETIMAT P6 3p+N B 3	001900405	ETIMAT P6 3p+N C 3	001900425	ETIMAT P6 3p+N D 3	001900445	3/27
4		ETIMAT P6 3p+N B 4	001900406	ETIMAT P6 3p+N C 4	001900426	ETIMAT P6 3p+N D 4	001900446	3/27
6		ETIMAT P6 3p+N B 6	001900407	ETIMAT P6 3p+N C 6	001900427	ETIMAT P6 3p+N D 6	001900447	3/27
10	415	ETIMAT P6 3p+N B 10	001900408	ETIMAT P6 3p+N C 10	001900428	ETIMAT P6 3p+N D 10	001900448	3/27
13		ETIMAT P6 3p+N B 13	001900409	ETIMAT P6 3p+N C 13	001900429	ETIMAT P6 3p+N D 13	001900449	3/27
16		ETIMAT P6 3p+N B 16	001900410	ETIMAT P6 3p+N C 16	001900430	ETIMAT P6 3p+N D 16	001900450	3/27
20		ETIMAT P6 3p+N B 20	001900411	ETIMAT P6 3p+N C 20	001900431	ETIMAT P6 3p+N D 20	001900451	3/27
25		ETIMAT P6 3p+N B 25	001900412	ETIMAT P6 3p+N C 25	001900432	ETIMAT P6 3p+N D 25	001900452	3/27
32		ETIMAT P6 3p+N B 32	001900413	ETIMAT P6 3p+N C 32	001900433	ETIMAT P6 3p+N D 32	001900453	3/27
40		ETIMAT P6 3p+N B 40	001900414	ETIMAT P6 3p+N C 40	001900434	ETIMAT P6 3p+N D 40	001900454	3/27
50		ETIMAT P6 3p+N B 50	001900415	ETIMAT P6 3p+N C 50	001900435	ETIMAT P6 3p+N D 50	001900455	3/27
63		ETIMAT P6 3p+N B 63	001900416	ETIMAT P6 3p+N C 63	001900436	/	/	3/27



Circuit breakers type ETIMAT P6 / 3-pole + N are suitable for use as 4-pole circuit breakers

ASTI / Miniature Circuit Breakers

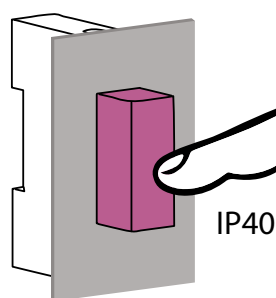
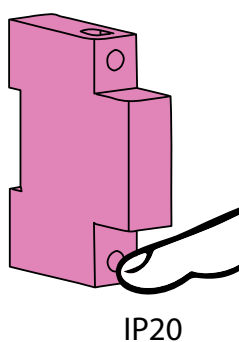
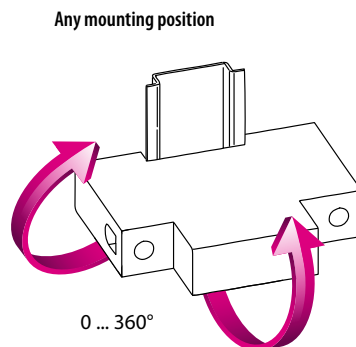
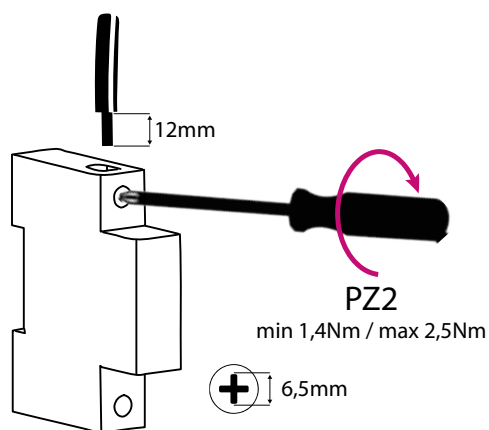

Effect of the ambient temperature on the tripping characteristic

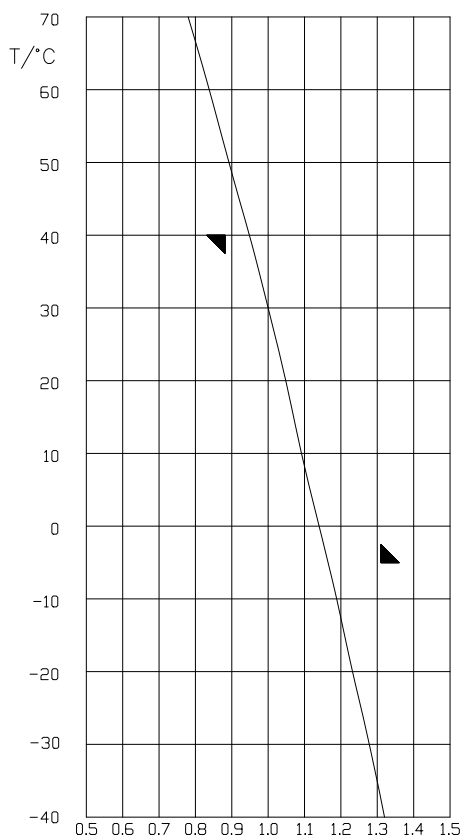

I _n [A]	Ambient temperature T/°C											
	-40	-30	-20	-10	0	10	20	30	40	50	60	70
0,5	0,66	0,64	0,62	0,60	0,57	0,55	0,53	0,5	0,48	0,45	0,42	0,39
1	1,32	1,28	1,23	1,19	1,14	1,09	1,05	1	0,95	0,89	0,84	0,78
1,6	2,11	2,05	1,97	1,90	1,82	1,74	1,68	1,6	1,52	1,42	1,34	1,25
2	2,64	2,56	2,46	2,38	2,28	2,18	2,10	2	1,90	1,78	1,68	1,56
4	5,28	5,12	4,92	4,76	4,56	4,36	4,20	4	3,80	3,56	3,36	3,12
6	7,92	7,68	7,38	7,14	6,84	6,54	6,30	6	5,70	5,34	5,04	4,68
10	13,2	12,8	12,3	11,9	11,4	10,9	10,5	10	9,50	8,90	8,40	7,80
13	17,2	16,6	16,0	15,5	14,8	14,2	13,7	13	12,4	11,6	10,9	10,1
16	21,1	20,5	19,7	19,0	18,2	17,4	16,8	16	15,2	14,2	13,4	12,5
20	26,4	25,6	24,6	23,8	22,8	21,8	21,0	20	19,0	17,8	16,8	15,6
25	33,0	32,0	30,8	29,8	28,5	27,3	26,3	25	23,8	22,3	21,0	19,5
32	42,2	41,0	39,4	38,1	36,5	34,9	33,6	32	30,4	28,5	26,9	25,0
40	52,8	51,2	49,2	47,6	45,6	43,6	42,0	40	38,0	35,6	33,6	31,2
50	66,0	64,0	61,5	59,5	57,0	54,5	52,6	50	47,5	44,5	42,0	39,0
63	83,2	80,6	77,5	75,0	71,8	68,7	66,2	63	59,9	56,1	52,9	49,1

Correction factor is valid for current with times over 30 s

$$k = \frac{I(x^{\circ}\text{C})}{I(30^{\circ}\text{C})}$$

I(x°C) - test current at x ambient temperature
 I(30°C) - test current at 30°C ambient temperature

Resistance and power dissipation

characteristic	I_n [A]	R/pole [mΩ]	P/pole [w]
B, C	0,5	3587	1,16
	1	935	1,21
	1,6	382	1,26
	2	264	1,37
	3	/	/
	4	69,6	1,38
	6	40,3	1,96
	10	16,9	2,00
	13	11,4	2,08
	16	8,17	2,26
	20	6,73	2,53
	25	5,03	2,96
	32	3,92	3,44
	40	/	/
	50	2,22	3,57
	63	1,71	4,59
D	0,5	/	/
	1	1183	1,55
	1,6	/	/
	2	303	1,58
	3	135	1,52
	4	81,8	1,66
	6	40,0	1,78
	10	17,3	1,57
	13	11,3	2,04
	16	8,59	2,31
	20	7,17	2,73
	25	4,77	2,91
	32	3,92	3,44
	40	/	/
	50	/	/
	63	/	/

Selectivity

ETIMAT	gGNV										
	20	25	32	35	40	50	63	80	100	125	160
B 6	0,5	0,78	1,2	1,4	1,7	2,4	4,6	6,0	6,0	6,0	6,0
B 10/13	0,45	0,65	1,1	1,3	1,6	2,2	4,0	6,0	6,0	6,0	6,0
B 16		0,55	1,0	1,2	1,5	2,0	3,6	5,5	6,0	6,0	6,0
B 20			0,85	1,2	1,5	1,8	3,1	4,6	6,0	6,0	6,0
B 25				1,1	1,4	1,7	2,9	4,0	6,0	6,0	6,0
B 32					1,3	1,6	2,5	3,4	5,5	6,0	6,0
B 40						1,5	2,2	3,1	4,9	6,0	6,0
B 50							2,1	2,9	4,0	6,0	6,0
B 63								2,5	3,3	5,1	6,0
ETIMAT	gGNV										
	20	25	32	35	40	50	63	80	100	125	160
C,D 6	0,52	0,82	1,3	1,5	2,0	2,7	5,1	6,0	6,0	6,0	6,0
C,D 10/13	0,47	0,70	1,1	1,4	1,8	2,3	4,0	6,0	6,0	6,0	6,0
C,D 16		0,61	0,92	1,2	1,5	1,9	3,2	5,0	6,0	6,0	6,0
C,D 20			0,90	1,1	1,4	1,7	2,9	4,2	6,0	6,0	6,0
C,D 25				1,0	1,3	1,6	2,7	3,9	6,0	6,0	6,0
C,D 32					1,2	1,5	2,3	3,4	5,2	6,0	6,0
C,D 40						1,4	2,1	3,0	4,6	6,0	6,0
C,D 50							2,0	2,7	3,8	6,0	6,0
C,D 63								2,3	3,2	5,5	6,0

R: measured at 0.1*In
P: measured at In

Effect of number of poles on the tripping characteristic ETIMAT P6

Correction factor K_n

Number of devices	K_n
1	1
2	0,95
3	0,91
4	0,87
5	0,84
6	0,81
7	0,79
8	0,78
9	0,77
>9	0,77

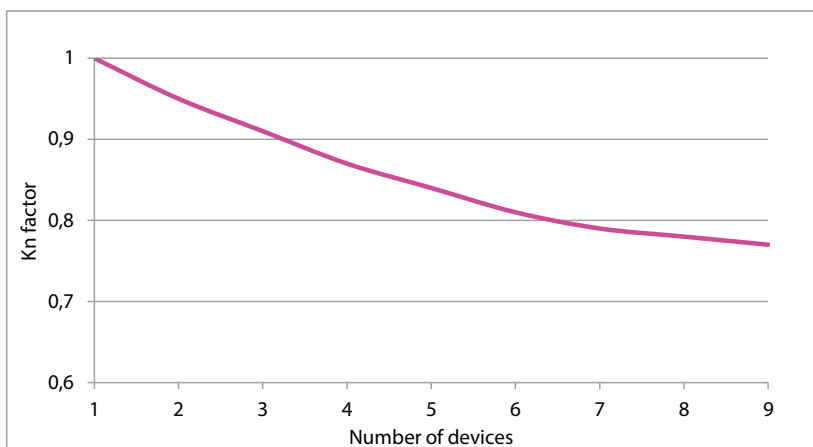

Time current characteristics I/t at 50 and 60Hz, ETIMAT P6

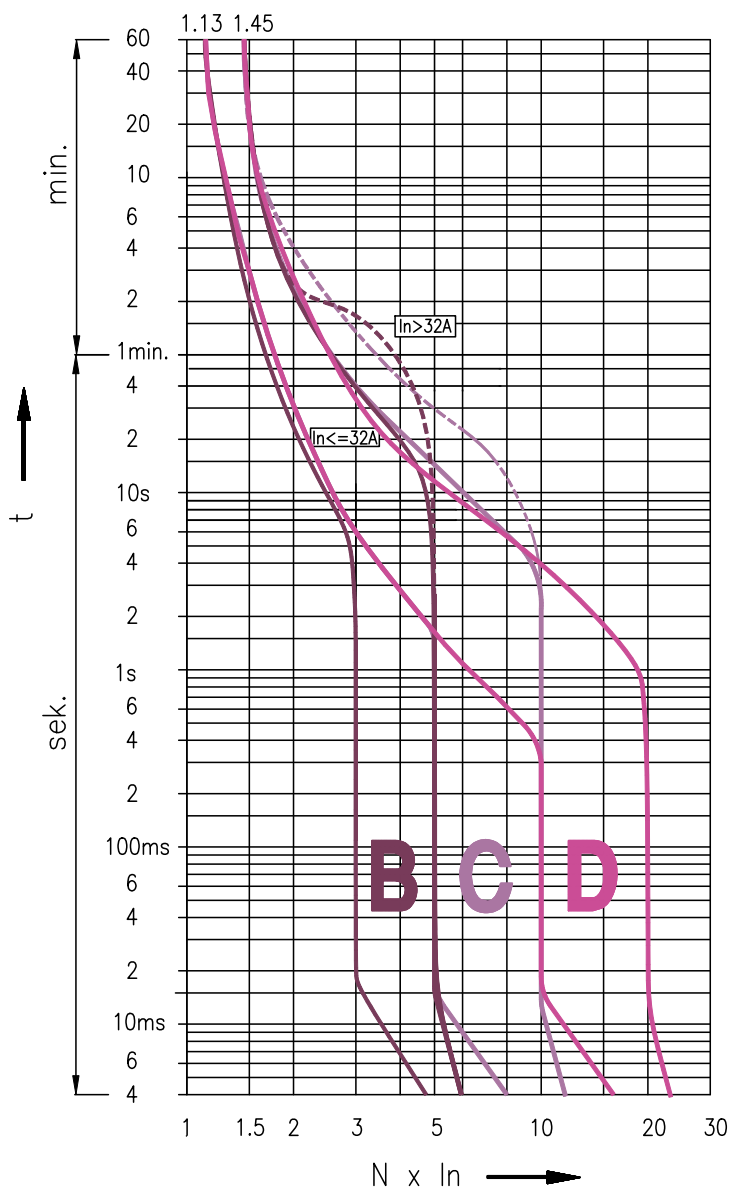

Conductor cross-section [mm ²]	Number of single conductors, rigid, single-wire CU conductor				
	1	2	3	4	5
1,5	✓	✓	✓	✓	✗
2,5	✓	✓	✓	✗	✗
4	✓	✓	✓	✗	✗
6	✓	✓	✗	✗	✗
10	✓	✓	✗	✗	✗
16	✓	✗	✗	✗	✗
25	✓	✗	✗	✗	✗

Remark: When you use more than 2 cables you have to be careful how those cables are inserted to ensure proper pressure on each cable

Conductor cross-section [mm ²]	Number of single conductors, flexible Cu conductors with cable ferrule					
	1	2	3	4	5	6
1,5	✓	✓	✓	✓	✓	✓
2,5	✓	✓	✓	✓	✓	✓
4	✓	✓	✓	✓	✓	✓
6	✓	✓	✓	✗	✗	✗
10	✓	✓	✗	✗	✗	✗
16	✓	✗	✗	✗	✗	✗
25	✓	✗	✗	✗	✗	✗

Combination of rigid single-wire and flexible multi-wire Cu conductors is not allowed

Melting energy characteristics I²t ETIMAT P6

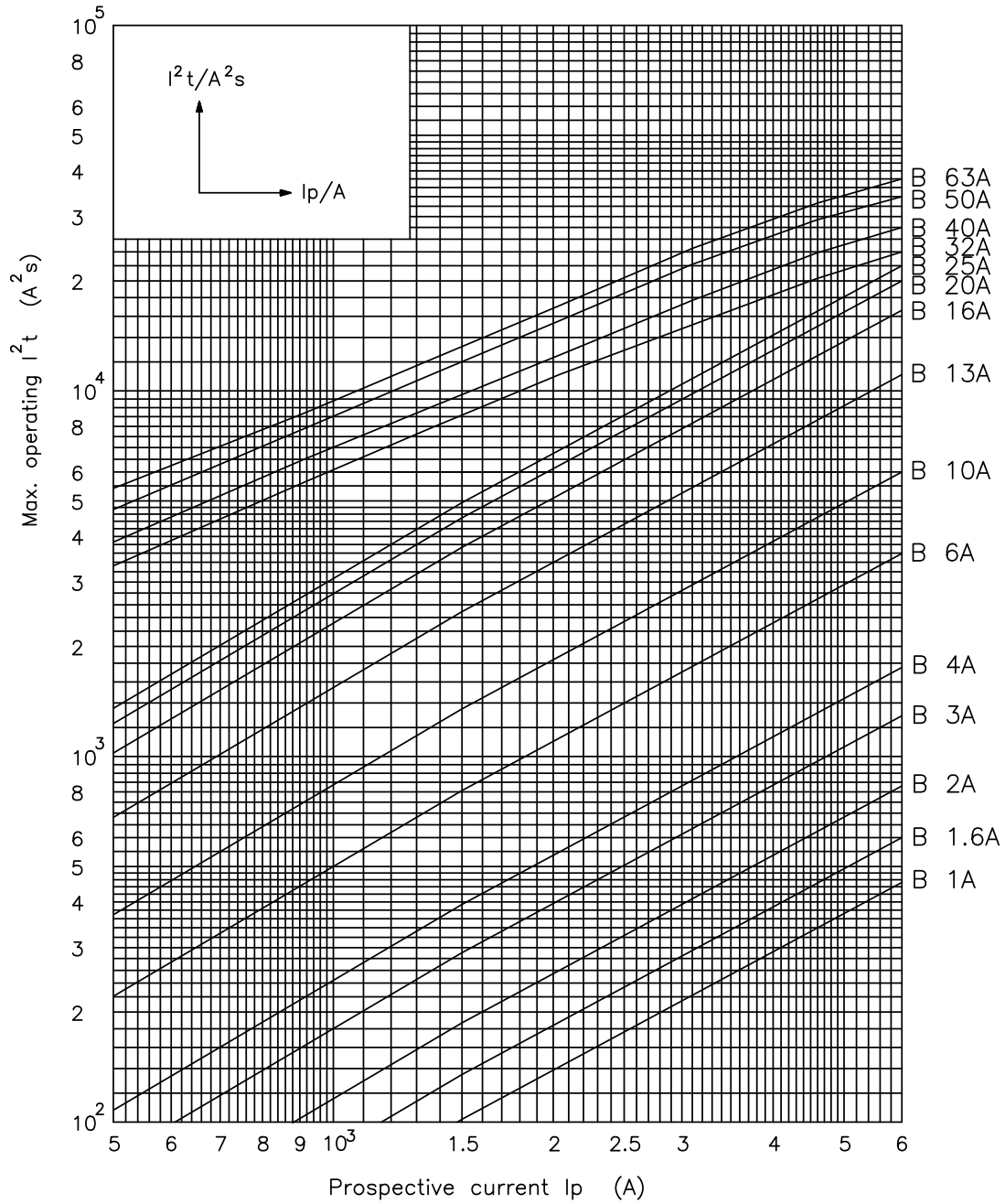

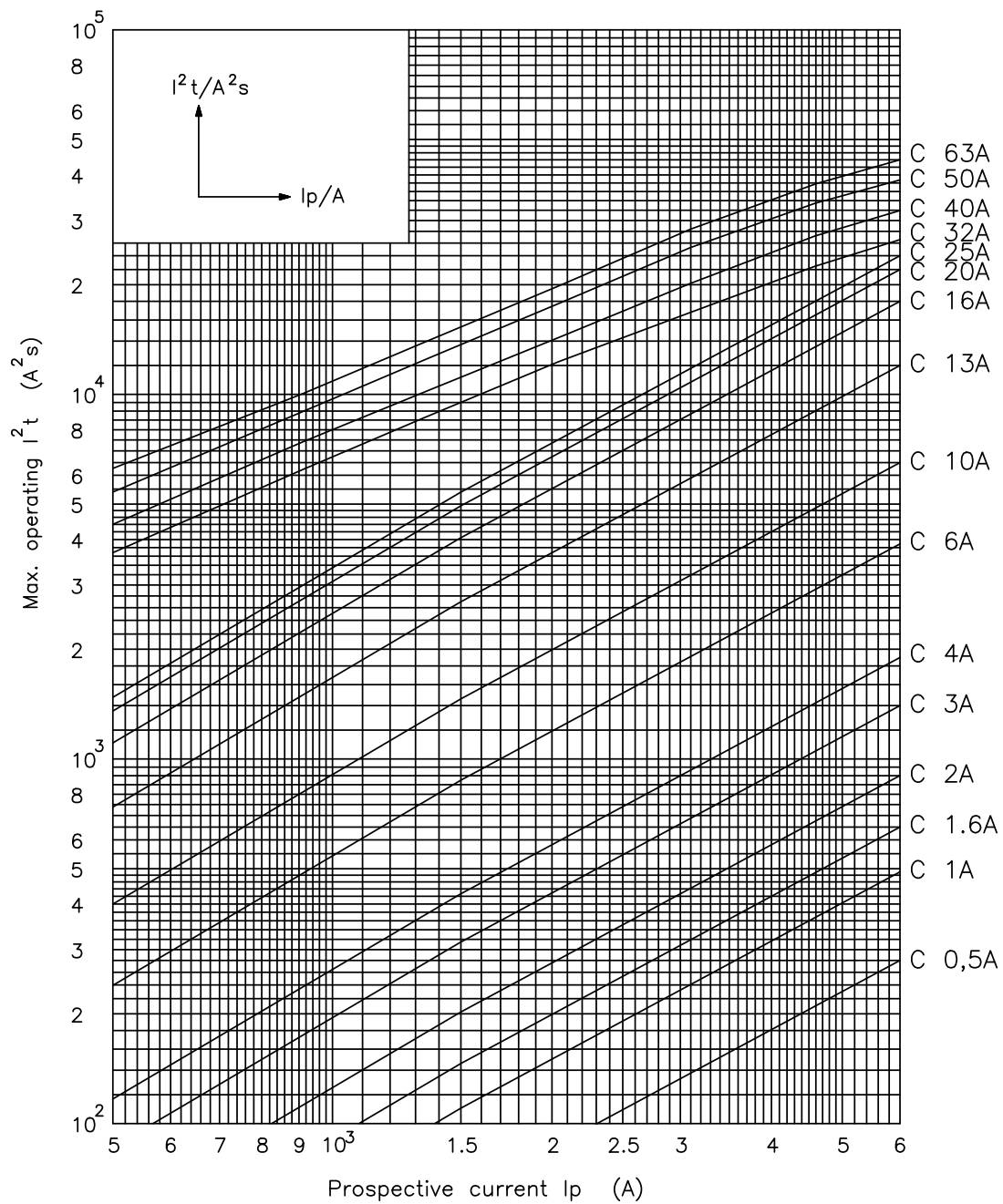
Melting energy characteristics I^2t ETIMAT P6

Melting energy characteristics I²t ETIMAT P6

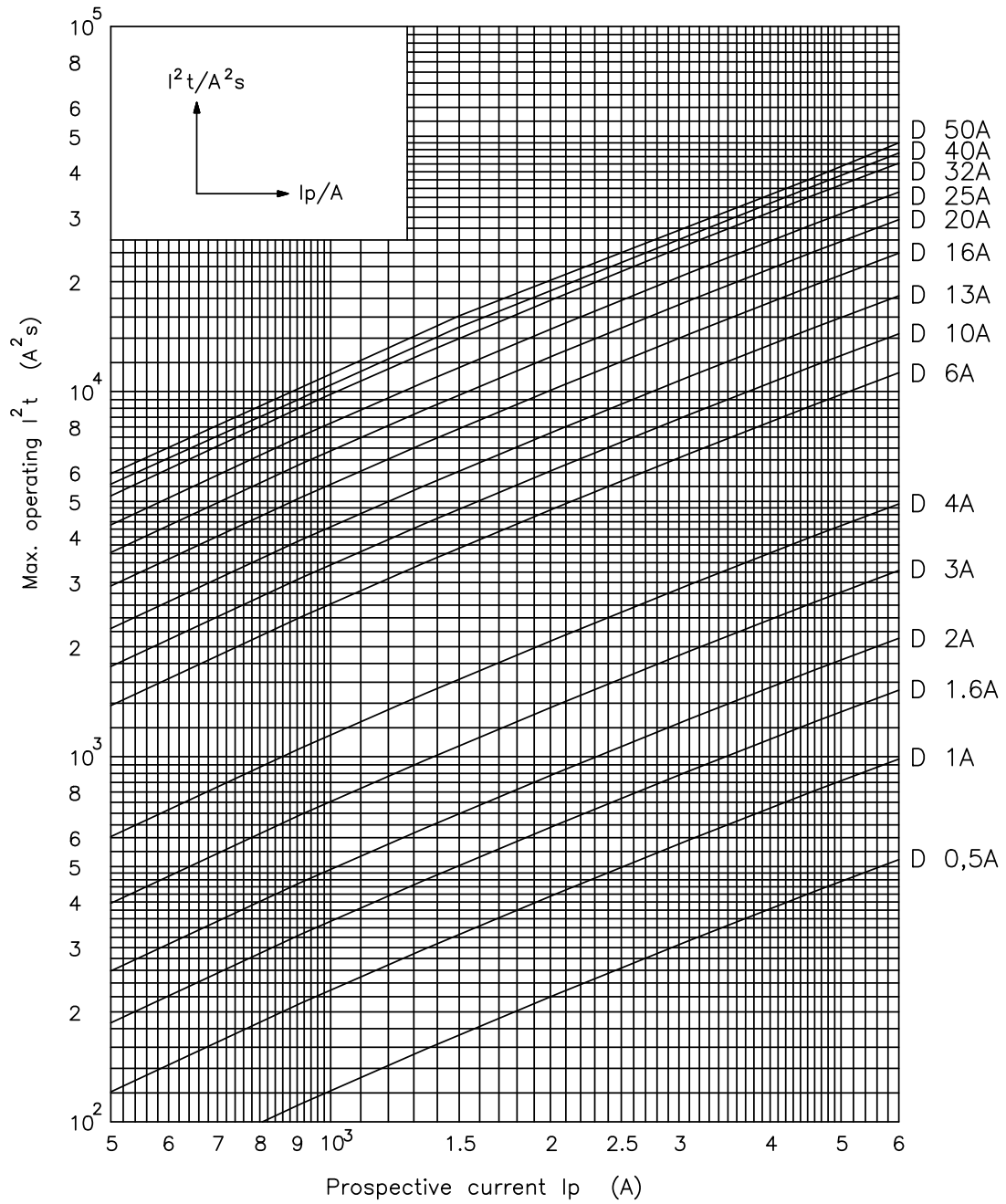

Cut-off characteristics I²t ETIMAT P6

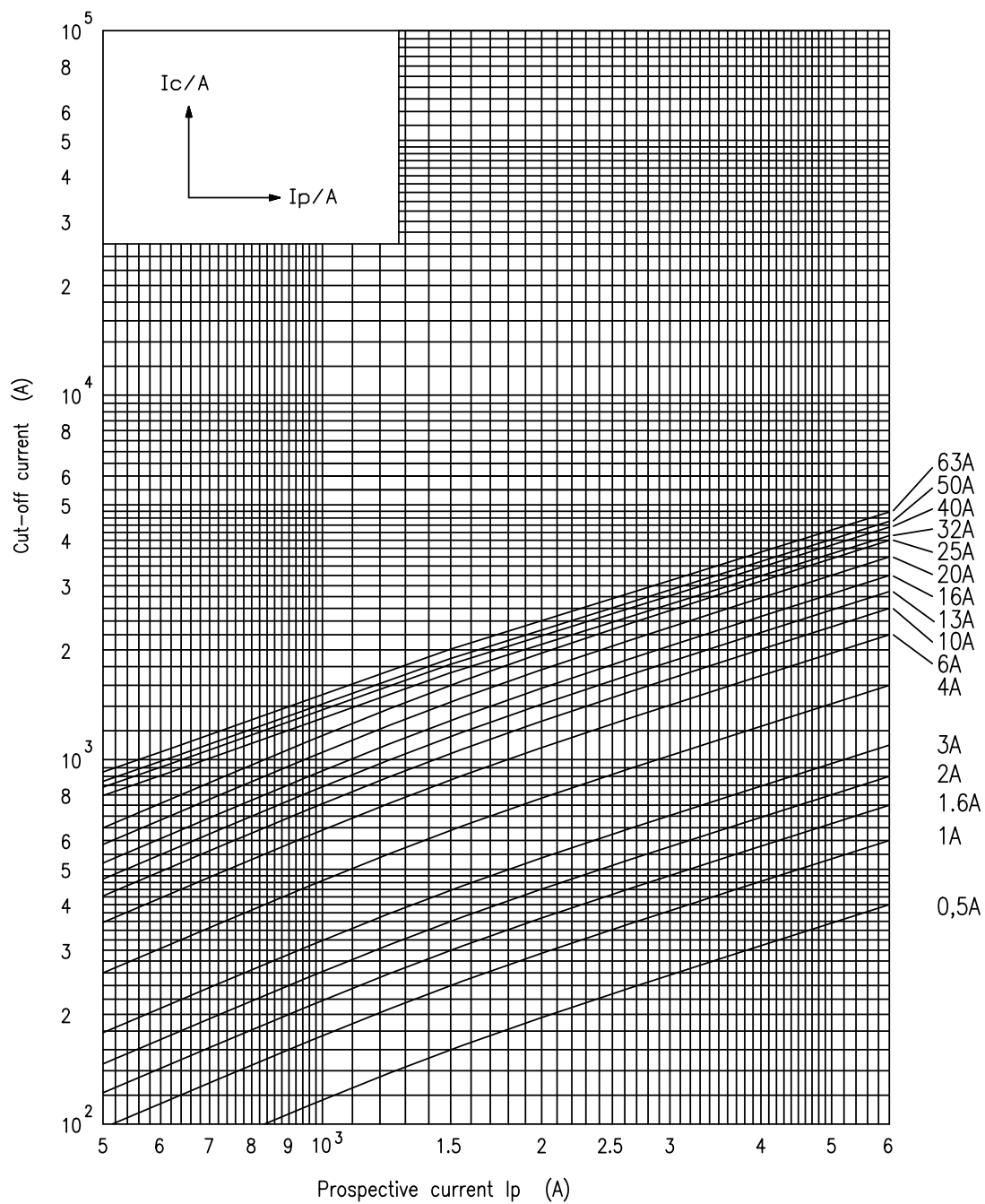

Miniature circuit breaker ETIMAT P10

Rated short-circuit capacity
10 kA

Rated current
0,5 - 63 A

Tripping characteristic
B, C, D, K, Z

Technical data for ETIMAT P10 and ETIMAT P10 Reset

Rated voltage	240/415V AC; max 60V DC/pol
Min. operating voltage	12V AC/DC
Max operating voltage	250/440V AC
Rated current	B:1-63A, C:0.5-63A, D:0.5-63A, K&Z:0.5-32A
Rated frequency	50/60Hz
Rated insulation voltage	500V
Rated impulse withstand voltage	6kV (acc. to 60947-2)
Shock resistance	30g, min 2 shocks, t=13ms
Rated short-circuit capacity	10 kA
Energy limiting class	3; B,C
Tripping characteristic	B, C, D, K, Z
Back-up fuse	100A gG
Index of protection	IP 20 (IP 40)
Terminals	1-25mm ² , min 1,4Nm / max 2,5Nm
Terminal screw	M5 (PoziDrive PZ2)
Mechanical endurance	20.000 op. cycles
Electrical endurance	20.000 op. cycles
Ambient temperature	max -40°C ... +70°C
Storage temperature	max -60°C ... +70°C
Supply possibility	top or bottom
Build-in width	18mm/pol
Insulating class	B
Overvoltage category	III
Pollution degree	2
Mounting on the rail	EN 60715
Mounting position	any
Sealing possibility	✓
Terminal cover	✓
Contact position indicator	✓
Locking device	✓
Resistance to vibrations acc. to IEC 60068-2-7	5g (10,60 & 500Hz)
Standards	IEC/EN 60898-1, IEC 60947-2

1p

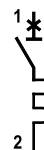

1p+n

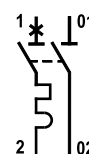

2p



3p



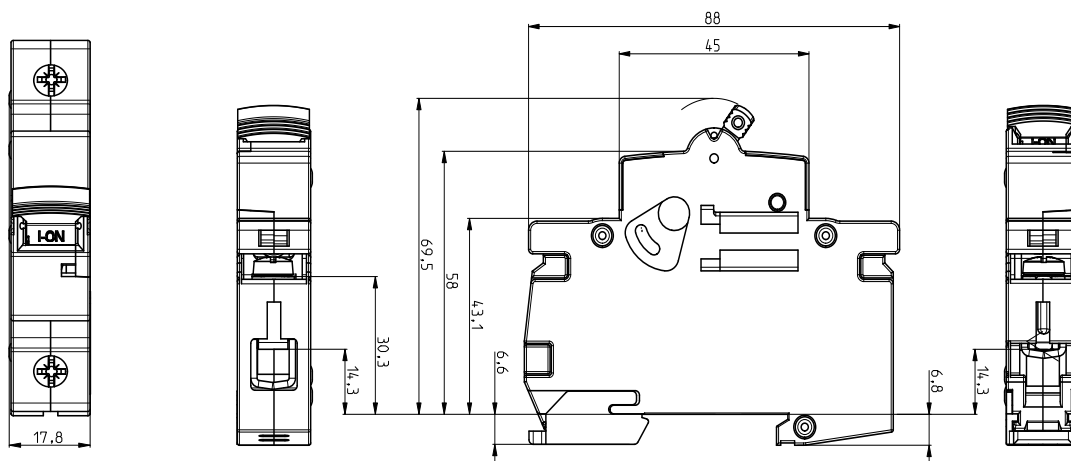
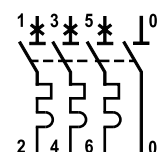

3p+n



Tripping characteristics



Characteristic	Test current	Tripping time	Result
B, C, D	$1,13 I_n$	$t \geq 3600$ s	No tripping
B, C, D	$1,45 I_n$	$t < 3600$ s	Tripping
B, C, D	$2,55 I_n$	$1s < t < 60$ s	Tripping
B	$3,00 I_n$	$t \leq 0,1$ s	No tripping
C	$5,00 I_n$	$t \leq 0,1$ s	No tripping
D	$10,00 I_n$	$t \leq 0,1$ s	No tripping
B	$5,00 I_n$	$t < 0,1$ s	Tripping
C	$10,00 I_n$	$t < 0,1$ s	Tripping
D	$20,00 I_n$	$t < 0,1$ s	Tripping
K, Z	$1,05 I_n$	$t > 7200$ s	No Tripping
K, Z	$1,20 I_n$	$t < 7200$ s	Tripping
K	$8,00 I_n$	$t \leq 0,2$ s	No Tripping
K	$12,00 I_n$	$t < 0,2$ s	Tripping
Z	$2,00 I_n$	$t \leq 0,2s$	No Tripping
Z	$3,00 I_n$	$t < 0,2s$	Tripping

1-pole, characteristic B, C



I_n [A]	U_n [V]	Type B	Code No. B	Type C	Code No. C		
0,5	240/415	/	/	ETIMAT P10 1p C0,5	001901021	92	12/108
1		ETIMAT P10 1p B1	001901002	ETIMAT P10 1p C1	001901022	92	12/108
1,6		ETIMAT P10 1p B1,6	001901003	ETIMAT P10 1p C1,6	001901023	92	12/108
2		ETIMAT P10 1p B2	001901004	ETIMAT P10 1p C2	001901024	92	12/108
3		ETIMAT P10 1p B3	001901005	ETIMAT P10 1p C3	001901025	92	12/108
4		ETIMAT P10 1p B4	001901006	ETIMAT P10 1p C4	001901026	92	12/108
6		ETIMAT P10 1p B6	001901007	ETIMAT P10 1p C6	001901027	92	12/108
10		ETIMAT P10 1p B10	001901008	ETIMAT P10 1p C10	001901028	92	12/108
13		ETIMAT P10 1p B13	001901009	ETIMAT P10 1p C13	001901029	92	12/108
16		ETIMAT P10 1p B16	001901010	ETIMAT P10 1p C16	001901030	92	12/108
20		ETIMAT P10 1p B20	001901011	ETIMAT P10 1p C20	001901031	102	12/108
25		ETIMAT P10 1p B25	001901012	ETIMAT P10 1p C25	001901032	105	12/108
32		ETIMAT P10 1p B32	001901013	ETIMAT P10 1p C32	001901033	105	12/108
40		ETIMAT P10 1p B40	001901014	ETIMAT P10 1p C40	001901034	105	12/108
50		ETIMAT P10 1p B50	001901015	ETIMAT P10 1p C50	001901035	111	12/108
63		ETIMAT P10 1p B63	001901016	ETIMAT P10 1p C63	001901036	115	12/108



1-pole, characteristic D, K, Z



I_n [A]	U_n [V]	Type D	Code No. D	Type K	Code No. K	Type Z	Code No. Z			
0,5	240/415	ETIMAT P10 1p D0,5	001901041	ETIMAT P10 1p K0,5	001901061	ETIMAT P10 1p Z0,5	001901081	102	12/108	
1		ETIMAT P10 1p D1	001901042	ETIMAT P10 1p K1	001901062	ETIMAT P10 1p Z1	001901082	102	12/108	
1,6		ETIMAT P10 1p D1,6	001901043	ETIMAT P10 1p K1,6	001901063	ETIMAT P10 1p Z1,6	001901083	102	12/108	
2		ETIMAT P10 1p D2	001901044	ETIMAT P10 1p K2	001901064	ETIMAT P10 1p Z2	001901084	102	12/108	
3		ETIMAT P10 1p D3	001901045	ETIMAT P10 1p K3	001901065	ETIMAT P10 1p Z3	001901085	102	12/108	
4		ETIMAT P10 1p D4	001901046	ETIMAT P10 1p K4	001901066	ETIMAT P10 1p Z4	001901086	102	12/108	
6		ETIMAT P10 1p D6	001901047	ETIMAT P10 1p K6	001901067	ETIMAT P10 1p Z6	001901087	102	12/108	
10		ETIMAT P10 1p D10	001901048	ETIMAT P10 1p K10	001901068	ETIMAT P10 1p Z10	001901088	102	12/108	
13		ETIMAT P10 1p D13	001901049	ETIMAT P10 1p K13	001901069	ETIMAT P10 1p Z13	001901089	102	12/108	
16		ETIMAT P10 1p D16	001901050	ETIMAT P10 1p K16	001901070	ETIMAT P10 1p Z16	001901090	102	12/108	
20		ETIMAT P10 1p D20	001901051	ETIMAT P10 1p K20	001901071	ETIMAT P10 1p Z20	001901091	102	12/108	
25		ETIMAT P10 1p D25	001901052	ETIMAT P10 1p K25	001901072	ETIMAT P10 1p Z25	001901092	105	12/108	
32		ETIMAT P10 1p D32	001901053	ETIMAT P10 1p K32	001901073	ETIMAT P10 1p Z32	001901093	105	12/108	
40		ETIMAT P10 1p D40	001901054	/	/	/	/	/	105	12/108
50		ETIMAT P10 1p D50	001901055	/	/	/	/	/	111	12/108

1-pole + N, characteristic B, C



I_n [A]	U_n [V]	Type B	Code No. B	Type C	Code No. C		
0,5		/	/	ETIMAT P10 1p+N C0,5	001901121	184	6/54
1		ETIMAT P10 1p+N B1	001901102	ETIMAT P10 1p+N C1	001901122	184	6/54
1,6		ETIMAT P10 1p+N B1,6	001901103	ETIMAT P10 1p+N C1,6	001901123	184	6/54
2		ETIMAT P10 1p+N B2	001901104	ETIMAT P10 1p+N C2	001901124	184	6/54
3		ETIMAT P10 1p+N B3	001901105	ETIMAT P10 1p+N C3	001901125	184	6/54
4		ETIMAT P10 1p+N B4	001901106	ETIMAT P10 1p+N C4	001901126	184	6/54
6		ETIMAT P10 1p+N B6	001901107	ETIMAT P10 1p+N C6	001901127	184	6/54
10	240	ETIMAT P10 1p+N B10	001901108	ETIMAT P10 1p+N C10	001901128	184	6/54
13		ETIMAT P10 1p+N B13	001901109	ETIMAT P10 1p+N C13	001901129	184	6/54
16		ETIMAT P10 1p+N B16	001901110	ETIMAT P10 1p+N C16	001901130	184	6/54
20		ETIMAT P10 1p+N B20	001901111	ETIMAT P10 1p+N C20	001901131	205	6/54
25		ETIMAT P10 1p+N B25	001901112	ETIMAT P10 1p+N C25	001901132	210	6/54
32		ETIMAT P10 1p+N B32	001901113	ETIMAT P10 1p+N C32	001901133	210	6/54
40		ETIMAT P10 1p+N B40	001901114	ETIMAT P10 1p+N C40	001901134	210	6/54
50		ETIMAT P10 1p+N B50	001901115	ETIMAT P10 1p+N C50	001901135	223	6/54
63		ETIMAT P10 1p+N B63	001901116	ETIMAT P10 1p+N C63	001901136	230	6/54



1-pole + N, characteristic D, K, Z



I_n [A]	U_n [V]	Type D	Code No. D	Type K	Code No. K	Type Z	Code No. Z		
0,5		ETIMAT P10 1p+N D0,5	001901141	ETIMAT P10 1p+N K0,5	001901161	ETIMAT P10 1p+N Z0,5	001901181	205	6/54
1		ETIMAT P10 1p+N D1	001901142	ETIMAT P10 1p+N K1	001901162	ETIMAT P10 1p+N Z1	001901182	205	6/54
1,6		ETIMAT P10 1p+N D1,6	001901143	ETIMAT P10 1p+N K1,6	001901163	ETIMAT P10 1p+N Z1,6	001901183	205	6/54
2		ETIMAT P10 1p+N D2	001901144	ETIMAT P10 1p+N K2	001901164	ETIMAT P10 1p+N Z2	001901184	205	6/54
3		ETIMAT P10 1p+N D3	001901145	ETIMAT P10 1p+N K3	001901165	ETIMAT P10 1p+N Z3	001901185	205	6/54
4		ETIMAT P10 1p+N D4	001901146	ETIMAT P10 1p+N K4	001901166	ETIMAT P10 1p+N Z4	001901186	205	6/54
6		ETIMAT P10 1p+N D6	001901147	ETIMAT P10 1p+N K6	001901167	ETIMAT P10 1p+N Z6	001901187	205	6/54
10	240	ETIMAT P10 1p+N D10	001901148	ETIMAT P10 1p+N K10	001901168	ETIMAT P10 1p+N Z10	001901188	205	6/54
13		ETIMAT P10 1p+N D13	001901149	ETIMAT P10 1p+N K13	001901169	ETIMAT P10 1p+N Z13	001901189	205	6/54
16		ETIMAT P10 1p+N D16	001901150	ETIMAT P10 1p+N K16	001901170	ETIMAT P10 1p+N Z16	001901190	205	6/54
20		ETIMAT P10 1p+N D20	001901151	ETIMAT P10 1p+N K20	001901171	ETIMAT P10 1p+N Z20	001901191	205	6/54
25		ETIMAT P10 1p+N D25	001901152	ETIMAT P10 1p+N K25	001901172	ETIMAT P10 1p+N Z25	001901192	210	6/54
32		ETIMAT P10 1p+N D32	001901153	ETIMAT P10 1p+N K32	001901173	ETIMAT P10 1p+N Z32	001901193	210	6/54
40		ETIMAT P10 1p+N D40	001901154	/	/	/	/	210	6/54
50		ETIMAT P10 1p+N D50	001901155	/	/	/	/	223	6/54

2-pole, characteristic B, C



I_n [A]	U_n [V]	Type B	Code No. B	Type C	Code No. C		
0,5		/	/	ETIMAT P10 2p C0,5	001901221	184	6/54
1		ETIMAT P10 2p B1	001901202	ETIMAT P10 2p C1	001901222	184	6/54
1,6		ETIMAT P10 2p B1,6	001901203	ETIMAT P10 2p C1,6	001901223	184	6/54
2		ETIMAT P10 2p B2	001901204	ETIMAT P10 2p C2	001901224	184	6/54
3		ETIMAT P10 2p B3	001901205	ETIMAT P10 2p C3	001901225	184	6/54
4		ETIMAT P10 2p B4	001901206	ETIMAT P10 2p C4	001901226	184	6/54
6		ETIMAT P10 2p B6	001901207	ETIMAT P10 2p C6	001901227	184	6/54
10	415	ETIMAT P10 2p B10	001901208	ETIMAT P10 2p C10	001901228	184	6/54
13		ETIMAT P10 2p B13	001901209	ETIMAT P10 2p C13	001901229	184	6/54
16		ETIMAT P10 2p B16	001901210	ETIMAT P10 2p C16	001901230	184	6/54
20		ETIMAT P10 2p B20	001901211	ETIMAT P10 2p C20	001901231	205	6/54
25		ETIMAT P10 2p B25	001901212	ETIMAT P10 2p C25	001901232	210	6/54
32		ETIMAT P10 2p B32	001901213	ETIMAT P10 2p C32	001901233	210	6/54
40		ETIMAT P10 2p B40	001901214	ETIMAT P10 2p C40	001901234	210	6/54
50		ETIMAT P10 2p B50	001901215	ETIMAT P10 2p C50	001901235	223	6/54
63		ETIMAT P10 2p B63	001901216	ETIMAT P10 2p C63	001901236	230	6/54





2-pole, characteristic D, K, Z

I_n [A]	U_n [V]	Type D	Code No. D	Type K	Code No. K	Type Z	Code No. Z		
0,5	415	ETIMAT P10 2p D0,5	001901241	ETIMAT P10 2p K0,5	001901261	ETIMAT P10 2p Z0,5	001901281	205	6/54
1		ETIMAT P10 2p D1	001901242	ETIMAT P10 2p K1	001901262	ETIMAT P10 2p Z1	001901282	205	6/54
1,6		ETIMAT P10 2p D1,6	001901243	ETIMAT P10 2p K1,6	001901263	ETIMAT P10 2p Z1,6	001901283	205	6/54
2		ETIMAT P10 2p D2	001901244	ETIMAT P10 2p K2	001901264	ETIMAT P10 2p Z2	001901284	205	6/54
3		ETIMAT P10 2p D3	001901245	ETIMAT P10 2p K3	001901265	ETIMAT P10 2p Z3	001901285	205	6/54
4		ETIMAT P10 2p D4	001901246	ETIMAT P10 2p K4	001901266	ETIMAT P10 2p Z4	001901286	205	6/54
6		ETIMAT P10 2p D6	001901247	ETIMAT P10 2p K6	001901267	ETIMAT P10 2p Z6	001901287	205	6/54
10		ETIMAT P10 2p D10	001901248	ETIMAT P10 2p K10	001901268	ETIMAT P10 2p Z10	001901288	205	6/54
13		ETIMAT P10 2p D13	001901249	ETIMAT P10 2p K13	001901269	ETIMAT P10 2p Z13	001901289	205	6/54
16		ETIMAT P10 2p D16	001901250	ETIMAT P10 2p K16	001901270	ETIMAT P10 2p Z16	001901290	205	6/54
20		ETIMAT P10 2p D20	001901251	ETIMAT P10 2p K20	001901271	ETIMAT P10 2p Z20	001901291	205	6/54
25		ETIMAT P10 2p D25	001901252	ETIMAT P10 2p K25	001901272	ETIMAT P10 2p Z25	001901292	210	6/54
32		ETIMAT P10 2p D32	001901253	ETIMAT P10 2p K32	001901273	ETIMAT P10 2p Z32	001901293	210	6/54
40		ETIMAT P10 2p D40	001901254	/	/	/	/	210	6/54
50		ETIMAT P10 2p D50	001901255	/	/	/	/	223	6/54



3-pole, characteristic B, C

I_n [A]	U_n [V]	Type B	Code No. B	Type C	Code No. C		
0,5	415	/	/	ETIMAT P10 3p C0,5	001901321	277	4/36
1		ETIMAT P10 3p B1	001901302	ETIMAT P10 3p C1	001901322	277	4/36
1,6		ETIMAT P10 3p B1,6	001901303	ETIMAT P10 3p C1,6	001901323	277	4/36
2		ETIMAT P10 3p B2	001901304	ETIMAT P10 3p C2	001901324	277	4/36
3		ETIMAT P10 3p B3	001901305	ETIMAT P10 3p C3	001901325	277	4/36
4		ETIMAT P10 3p B4	001901306	ETIMAT P10 3p C4	001901326	277	4/36
6		ETIMAT P10 3p B6	001901307	ETIMAT P10 3p C6	001901327	277	4/36
10		ETIMAT P10 3p B10	001901308	ETIMAT P10 3p C10	001901328	277	4/36
13		ETIMAT P10 3p B13	001901309	ETIMAT P10 3p C13	001901329	277	4/36
16		ETIMAT P10 3p B16	001901310	ETIMAT P10 3p C16	001901330	277	4/36
20		ETIMAT P10 3p B20	001901311	ETIMAT P10 3p C20	001901331	308	4/36
25		ETIMAT P10 3p B25	001901312	ETIMAT P10 3p C25	001901332	316	4/36
32		ETIMAT P10 3p B32	001901313	ETIMAT P10 3p C32	001901333	316	4/36
40		ETIMAT P10 3p B40	001901314	ETIMAT P10 3p C40	001901334	316	4/36
50		ETIMAT P10 3p B50	001901315	ETIMAT P10 3p C50	001901335	335	4/36
63	ETIMAT P10 3p B63	001901316	ETIMAT P10 3p C63	001901336	345	4/36	



**3-pole, characteristic D, K, Z**

I_n [A]	U_n [V]	Type D	Code No. D	Type K	Code No. K	Type Z	Code No. Z		
0,5	415	ETIMAT P10 3p D0,5	001901341	ETIMAT P10 3p K0,5	001901361	ETIMAT P10 3p Z0,5	001901381	308	4/36
1		ETIMAT P10 3p D1	001901342	ETIMAT P10 3p K1	001901362	ETIMAT P10 3p Z1	001901382	308	4/36
1,6		ETIMAT P10 3p D1,6	001901343	ETIMAT P10 3p K1,6	001901363	ETIMAT P10 3p Z1,6	001901383	308	4/36
2		ETIMAT P10 3p D2	001901344	ETIMAT P10 3p K2	001901364	ETIMAT P10 3p Z2	001901384	308	4/36
3		ETIMAT P10 3p D3	001901345	ETIMAT P10 3p K3	001901365	ETIMAT P10 3p Z3	001901385	308	4/36
4		ETIMAT P10 3p D4	001901346	ETIMAT P10 3p K4	001901366	ETIMAT P10 3p Z4	001901386	308	4/36
6		ETIMAT P10 3p D6	001901347	ETIMAT P10 3p K6	001901367	ETIMAT P10 3p Z6	001901387	308	4/36
10		ETIMAT P10 3p D10	001901348	ETIMAT P10 3p K10	001901368	ETIMAT P10 3p Z10	001901388	308	4/36
13		ETIMAT P10 3p D13	001901349	ETIMAT P10 3p K13	001901369	ETIMAT P10 3p Z13	001901389	308	4/36
16		ETIMAT P10 3p D16	001901350	ETIMAT P10 3p K16	001901370	ETIMAT P10 3p Z16	001901390	308	4/36
20		ETIMAT P10 3p D20	001901351	ETIMAT P10 3p K20	001901371	ETIMAT P10 3p Z20	001901391	308	4/36
25		ETIMAT P10 3p D25	001901352	ETIMAT P10 3p K25	001901372	ETIMAT P10 3p Z25	001901392	316	4/36
32		ETIMAT P10 3p D32	001901353	ETIMAT P10 3p K32	001901373	ETIMAT P10 3p Z32	001901393	316	4/36
40		ETIMAT P10 3p D40	001901354	/	/	/	/	316	4/36
50		ETIMAT P10 3p D50	001901355	/	/	/	/	335	4/36

3-pole + N, characteristic B, C

I_n [A]	U_n [V]	Type B	Code No. B	Type C	Code No. C		
0,5		-	-	ETIMAT P10 3p+N C0,5	001901421	370	3/27
1		ETIMAT P10 3p+N B1	001901402	ETIMAT P10 3p+N C1	001901422	370	3/27
1,6		ETIMAT P10 3p+N B1,6	001901403	ETIMAT P10 3p+N C1,6	001901423	370	3/27
2		ETIMAT P10 3p+N B2	001901404	ETIMAT P10 3p+N C2	001901424	370	3/27
3		ETIMAT P10 3p+N B3	001901405	ETIMAT P10 3p+N C3	001901425	370	3/27
4		ETIMAT P10 3p+N B4	001901406	ETIMAT P10 3p+N C4	001901426	370	3/27
6		ETIMAT P10 3p+N B6	001901407	ETIMAT P10 3p+N C6	001901427	370	3/27
10	415	ETIMAT P10 3p+N B10	001901408	ETIMAT P10 3p+N C10	001901428	370	3/27
13		ETIMAT P10 3p+N B13	001901409	ETIMAT P10 3p+N C13	001901429	370	3/27
16		ETIMAT P10 3p+N B16	001901410	ETIMAT P10 3p+N C16	001901430	370	3/27
20		ETIMAT P10 3p+N B20	001901411	ETIMAT P10 3p+N C20	001901431	412	3/27
25		ETIMAT P10 3p+N B25	001901412	ETIMAT P10 3p+N C25	001901432	422	3/27
32		ETIMAT P10 3p+N B32	001901413	ETIMAT P10 3p+N C32	001901433	422	3/27
40		ETIMAT P10 3p+N B40	001901414	ETIMAT P10 3p+N C40	001901434	422	3/27
50		ETIMAT P10 3p+N B50	001901415	ETIMAT P10 3p+N C50	001901435	448	3/27
63		ETIMAT P10 3p+N B63	001901416	ETIMAT P10 3p+N C63	001901436	460	3/27

3-pole + N, characteristic D, K, Z

I_n [A]	U_n [V]	Type D	Code No. D	Type K	Code No. K	Type Z	Code No. Z		
0,5		ETIMAT P10 3p+N D0,5	001901441	ETIMAT P10 3p+N K0,5	001901461	ETIMAT P10 3p+N Z0,5	001901481	412	3/27
1		ETIMAT P10 3p+N D1	001901442	ETIMAT P10 3p+N K1	001901462	ETIMAT P10 3p+N Z1	001901482	412	3/27
1,6		ETIMAT P10 3p+N D1,6	001901443	ETIMAT P10 3p+N K1,6	001901463	ETIMAT P10 3p+N Z1,6	001901483	412	3/27
2		ETIMAT P10 3p+N D2	001901444	ETIMAT P10 3p+N K2	001901464	ETIMAT P10 3p+N Z2	001901484	412	3/27
3		ETIMAT P10 3p+N D3	001901445	ETIMAT P10 3p+N K3	001901465	ETIMAT P10 3p+N Z3	001901485	412	3/27
4		ETIMAT P10 3p+N D4	001901446	ETIMAT P10 3p+N K4	001901466	ETIMAT P10 3p+N Z4	001901486	412	3/27
6		ETIMAT P10 3p+N D6	001901447	ETIMAT P10 3p+N K6	001901467	ETIMAT P10 3p+N Z6	001901487	412	3/27
10	415	ETIMAT P10 3p+N D10	001901448	ETIMAT P10 3p+N K10	001901468	ETIMAT P10 3p+N Z10	001901488	412	3/27
13		ETIMAT P10 3p+N D13	001901449	ETIMAT P10 3p+N K13	001901469	ETIMAT P10 3p+N Z13	001901489	412	3/27
16		ETIMAT P10 3p+N D16	001901450	ETIMAT P10 3p+N K16	001901470	ETIMAT P10 3p+N Z16	001901490	412	3/27
20		ETIMAT P10 3p+N D20	001901451	ETIMAT P10 3p+N K20	001901471	ETIMAT P10 3p+N Z20	001901491	412	3/27
25		ETIMAT P10 3p+N D25	001901452	ETIMAT P10 3p+N K25	001901472	ETIMAT P10 3p+N Z25	001901492	422	3/27
32		ETIMAT P10 3p+N D32	001901453	ETIMAT P10 3p+N K32	001901473	ETIMAT P10 3p+N Z32	001901493	422	3/27
40		ETIMAT P10 3p+N D40	001901454	/	/	/	/	422	3/27
50		ETIMAT P10 3p+N D50	001901455	/	/	/	/	448	3/27

Circuit breakers type ETIMAT P10 / 3-pole + N are suitable for use as 4-pole circuit breakers

Miniature circuit breaker ETIMAT P10 Reset

Rated short-circuit capacity
10 kA

Rated current
0,5 - 63 A

Tripping characteristic
B, C

Special reset version

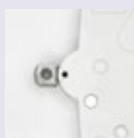

In the reset version, the toggle position clearly indicates the reason for tripping, preventing user mistakes and always making it clear whether the system turning off was intentional (manual) or

the result of a fault in the electrical circuit.

In case of overcurrent, the button moves to the "trip" (middle) position. In case of manual turn off, the button moves to the "off" (lowest) position.

1-pole

I_n [A]	U_n [V]	Type B	Code No. B	Type C	Code No. C		
0,5		/	/	ETIMAT P10/R 1p C0,5	001902021	92	12/108
1		ETIMAT P10/R 1p B1	001902002	ETIMAT P10/R 1p C1	001902022	92	12/108
1,6		ETIMAT P10/R 1p B1,6	001902003	ETIMAT P10/R 1p C1,6	001902023	92	12/108
2		ETIMAT P10/R 1p B2	001902004	ETIMAT P10/R 1p C2	001902024	92	12/108
3		ETIMAT P10/R 1p B3	001902005	ETIMAT P10/R 1p C3	001902025	92	12/108
4		ETIMAT P10/R 1p B4	001902006	ETIMAT P10/R 1p C4	001902026	92	12/108
6		ETIMAT P10/R 1p B6	001902007	ETIMAT P10/R 1p C6	001902027	92	12/108
10	240/415	ETIMAT P10/R 1p B10	001902008	ETIMAT P10/R 1p C10	001902028	92	12/108
13		ETIMAT P10/R 1p B13	001902009	ETIMAT P10/R 1p C13	001902029	92	12/108
16		ETIMAT P10/R 1p B16	001902010	ETIMAT P10/R 1p C16	001902030	92	12/108
20		ETIMAT P10/R 1p B20	001902011	ETIMAT P10/R 1p C20	001902031	102	12/108
25		ETIMAT P10/R 1p B25	001902012	ETIMAT P10/R 1p C25	001902032	105	12/108
32		ETIMAT P10/R 1p B32	001902013	ETIMAT P10/R 1p C32	001902033	105	12/108
40		ETIMAT P10/R 1p B40	001902014	ETIMAT P10/R 1p C40	001902034	105	12/108
50		ETIMAT P10/R 1p B50	001902015	ETIMAT P10/R 1p C50	001902035	111	12/108
63		ETIMAT P10/R 1p B63	001902016	ETIMAT P10/R 1p C63	001902036	115	12/108





1-pole + N

I_n [A]	U_n [V]	Type B	Code No. B	Type C	Code No. C		
0,5		/	/	ETIMAT P10/R 1p+N C0,5	001902121	184	6/54
1		ETIMAT P10/R 1p+N B1	001902102	ETIMAT P10/R 1p+N C1	001902122	184	6/54
1,6		ETIMAT P10/R 1p+N B1,6	001902103	ETIMAT P10/R 1p+N C1,6	001902123	184	6/54
2		ETIMAT P10/R 1p+N B2	001902104	ETIMAT P10/R 1p+N C2	001902124	184	6/54
3		ETIMAT P10/R 1p+N B3	001902105	ETIMAT P10/R 1p+N C3	001902125	184	6/54
4		ETIMAT P10/R 1p+N B4	001902106	ETIMAT P10/R 1p+N C4	001902126	184	6/54
6		ETIMAT P10/R 1p+N B6	001902107	ETIMAT P10/R 1p+N C6	001902127	184	6/54
10	240	ETIMAT P10/R 1p+N B10	001902108	ETIMAT P10/R 1p+N C10	001902128	184	6/54
13		ETIMAT P10/R 1p+N B13	001902109	ETIMAT P10/R 1p+N C13	001902129	184	6/54
16		ETIMAT P10/R 1p+N B16	001902110	ETIMAT P10/R 1p+N C16	001902130	184	6/54
20		ETIMAT P10/R 1p+N B20	001902111	ETIMAT P10/R 1p+N C20	001902131	205	6/54
25		ETIMAT P10/R 1p+N B25	001902112	ETIMAT P10/R 1p+N C25	001902132	210	6/54
32		ETIMAT P10/R 1p+N B32	001902113	ETIMAT P10/R 1p+N C32	001902133	210	6/54
40		ETIMAT P10/R 1p+N B40	001902114	ETIMAT P10/R 1p+N C40	001902134	210	6/54
50		ETIMAT P10/R 1p+N B50	001902115	ETIMAT P10/R 1p+N C50	001902135	223	6/54
63		ETIMAT P10/R 1p+N B63	001902116	ETIMAT P10/R 1p+N C63	001902136	230	6/54





2-pole

I_n [A]	U_n [V]	Type B	Code No. B	Type C	Code No. C		
0,5	415	/	/	ETIMAT P10/R 2p C0,5	001902221	184	6/54
1		ETIMAT P10/R 2p B1	001902202	ETIMAT P10/R 2p C1	001902222	184	6/54
1,6		ETIMAT P10/R 2p B1,6	001902203	ETIMAT P10/R 2p C1,6	001902223	184	6/54
2		ETIMAT P10/R 2p B2	001902204	ETIMAT P10/R 2p C2	001902224	184	6/54
3		ETIMAT P10/R 2p B3	001902205	ETIMAT P10/R 2p C3	001902225	184	6/54
4		ETIMAT P10/R 2p B4	001902206	ETIMAT P10/R 2p C4	001902226	184	6/54
6		ETIMAT P10/R 2p B6	001902207	ETIMAT P10/R 2p C6	001902227	184	6/54
10		ETIMAT P10/R 2p B10	001902208	ETIMAT P10/R 2p C10	001902228	184	6/54
13		ETIMAT P10/R 2p B13	001902209	ETIMAT P10/R 2p C13	001902229	184	6/54
16		ETIMAT P10/R 2p B16	001902210	ETIMAT P10/R 2p C16	001902230	184	6/54
20		ETIMAT P10/R 2p B20	001902211	ETIMAT P10/R 2p C20	001902231	205	6/54
25		ETIMAT P10/R 2p B25	001902212	ETIMAT P10/R 2p C25	001902232	210	6/54
32		ETIMAT P10/R 2p B32	001902213	ETIMAT P10/R 2p C32	001902233	210	6/54
40		ETIMAT P10/R 2p B40	001902214	ETIMAT P10/R 2p C40	001902234	210	6/54
50		ETIMAT P10/R 2p B50	001902215	ETIMAT P10/R 2p C50	001902235	223	6/54
63		ETIMAT P10/R 2p B63	001902216	ETIMAT P10/R 2p C63	001902236	230	6/54





3-pole

I_n [A]	U_n [V]	Type B	Code No. B	Type C	Code No. C		
0,5	415	/	/	ETIMAT P10/R 3p C0,5	001902321	277	4/36
1		ETIMAT P10/R 3p B1	001902302	ETIMAT P10/R 3p C1	001902322	277	4/36
1,6		ETIMAT P10/R 3p B1,6	001902303	ETIMAT P10/R 3p C1,6	001902323	277	4/36
2		ETIMAT P10/R 3p B2	001902304	ETIMAT P10/R 3p C2	001902324	277	4/36
3		ETIMAT P10/R 3p B3	001902305	ETIMAT P10/R 3p C3	001902325	277	4/36
4		ETIMAT P10/R 3p B4	001902306	ETIMAT P10/R 3p C4	001902326	277	4/36
6		ETIMAT P10/R 3p B6	001902307	ETIMAT P10/R 3p C6	001902327	277	4/36
10		ETIMAT P10/R 3p B10	001902308	ETIMAT P10/R 3p C10	001902328	277	4/36
13		ETIMAT P10/R 3p B13	001902309	ETIMAT P10/R 3p C13	001902329	277	4/36
16		ETIMAT P10/R 3p B16	001902310	ETIMAT P10/R 3p C16	001902330	277	4/36
20		ETIMAT P10/R 3p B20	001902311	ETIMAT P10/R 3p C20	001902331	308	4/36
25		ETIMAT P10/R 3p B25	001902312	ETIMAT P10/R 3p C25	001902332	316	4/36
32		ETIMAT P10/R 3p B32	001902313	ETIMAT P10/R 3p C32	001902333	316	4/36
40		ETIMAT P10/R 3p B40	001902314	ETIMAT P10/R 3p C40	001902334	316	4/36
50		ETIMAT P10/R 3p B50	001902315	ETIMAT P10/R 3p C50	001902335	335	4/36
63		ETIMAT P10/R 3p B63	001902316	ETIMAT P10/R 3p C63	001902336	345	4/36



3-pole + N

I_n [A]	U_n [V]	Type B	Code No. B	Type C	Code No. C		
0,5	415	/	/	ETIMAT P10/R 3p+N C0,5	001902421	370	3/27
1		ETIMAT P10/R 3p+N B1	001902402	ETIMAT P10/R 3p+N C1	001902422	370	3/27
1,6		ETIMAT P10/R 3p+N B1,6	001902403	ETIMAT P10/R 3p+N C1,6	001902423	370	3/27
2		ETIMAT P10/R 3p+N B2	001902404	ETIMAT P10/R 3p+N C2	001902424	370	3/27
3		ETIMAT P10/R 3p+N B3	001902405	ETIMAT P10/R 3p+N C3	001902425	370	3/27
4		ETIMAT P10/R 3p+N B4	001902406	ETIMAT P10/R 3p+N C4	001902426	370	3/27
6		ETIMAT P10/R 3p+N B6	001902407	ETIMAT P10/R 3p+N C6	001902427	370	3/27
10		ETIMAT P10/R 3p+N B10	001902408	ETIMAT P10/R 3p+N C10	001902428	370	3/27
13		ETIMAT P10/R 3p+N B13	001902409	ETIMAT P10/R 3p+N C13	001902429	370	3/27
16		ETIMAT P10/R 3p+N B16	001902410	ETIMAT P10/R 3p+N C16	001902430	370	3/27
20		ETIMAT P10/R 3p+N B20	001902411	ETIMAT P10/R 3p+N C20	001902431	412	3/27
25		ETIMAT P10/R 3p+N B25	001902412	ETIMAT P10/R 3p+N C25	001902432	422	3/27
32		ETIMAT P10/R 3p+N B32	001902413	ETIMAT P10/R 3p+N C32	001902433	422	3/27
40		ETIMAT P10/R 3p+N B40	001902414	ETIMAT P10/R 3p+N C40	001902434	422	3/27
50		ETIMAT P10/R 3p+N B50	001902415	ETIMAT P10/R 3p+N C50	001902435	448	3/27
63		ETIMAT P10/R 3p+N B63	001902416	ETIMAT P10/R 3p+N C63	001902436	460	3/27



Circuit breakers type ETIMAT P10 / 3-pole + N are suitable for use as 4-pole circuit breakers

ASTI / Miniature Circuit Breakers

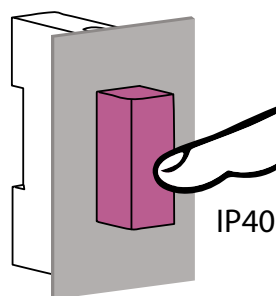
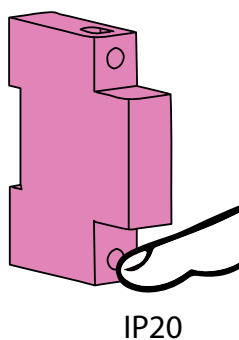
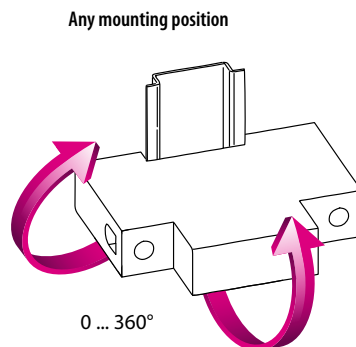
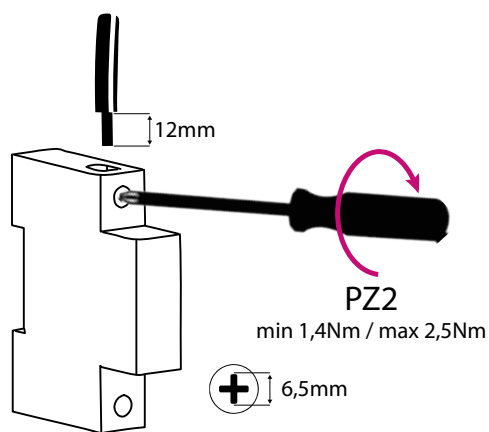

Effect of the ambient temperature on the tripping characteristic

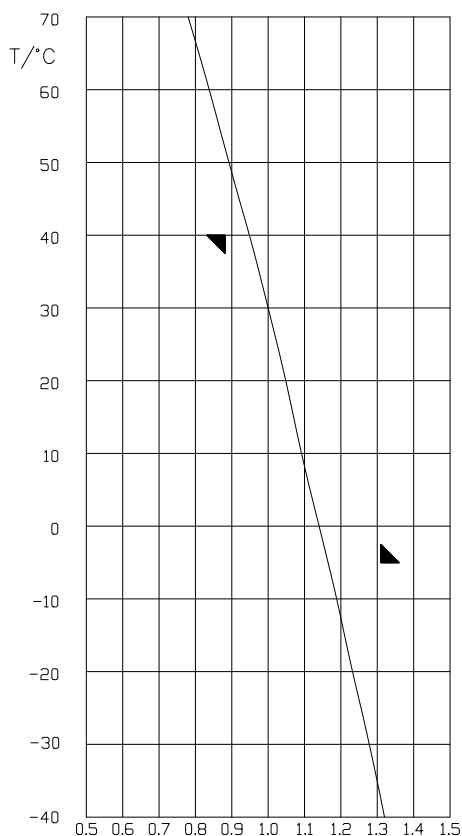

I _n [A]	Ambient temperature T/°C											
	-40	-30	-20	-10	0	10	20	30	40	50	60	70
0,5	0,66	0,64	0,62	0,60	0,57	0,55	0,53	0,5	0,48	0,45	0,42	0,39
1	1,32	1,28	1,23	1,19	1,14	1,09	1,05	1	0,95	0,89	0,84	0,78
1,6	2,11	2,05	1,97	1,90	1,82	1,74	1,68	1,6	1,52	1,42	1,34	1,25
2	2,64	2,56	2,46	2,38	2,28	2,18	2,10	2	1,90	1,78	1,68	1,56
4	5,28	5,12	4,92	4,76	4,56	4,36	4,20	4	3,80	3,56	3,36	3,12
6	7,92	7,68	7,38	7,14	6,84	6,54	6,30	6	5,70	5,34	5,04	4,68
10	13,2	12,8	12,3	11,9	11,4	10,9	10,5	10	9,50	8,90	8,40	7,80
13	17,2	16,6	16,0	15,5	14,8	14,2	13,7	13	12,4	11,6	10,9	10,1
16	21,1	20,5	19,7	19,0	18,2	17,4	16,8	16	15,2	14,2	13,4	12,5
20	26,4	25,6	24,6	23,8	22,8	21,8	21,0	20	19,0	17,8	16,8	15,6
25	33,0	32,0	30,8	29,8	28,5	27,3	26,3	25	23,8	22,3	21,0	19,5
32	42,2	41,0	39,4	38,1	36,5	34,9	33,6	32	30,4	28,5	26,9	25,0
40	52,8	51,2	49,2	47,6	45,6	43,6	42,0	40	38,0	35,6	33,6	31,2
50	66,0	64,0	61,5	59,5	57,0	54,5	52,6	50	47,5	44,5	42,0	39,0
63	83,2	80,6	77,5	75,0	71,8	68,7	66,2	63	59,9	56,1	52,9	49,1

Correction factor is valid for current with times over 30 s

$$k = \frac{I(x^{\circ}\text{C})}{I(30^{\circ}\text{C})}$$

I(x°C) - test current at x ambient temperature
I(30°C) - test current at 30°C ambient temperature

Resistance and power dissipation

characteristic	I_n [A]	R/pole [mΩ]	P/pole [w]	
B, C	0,5	3587	1,16	
	1	935	1,21	
	1,6	382	1,26	
	2	264	1,37	
	3	/	/	
	4	69,6	1,38	
	6	40,3	1,96	
	10	16,9	2,00	
	13	11,4	2,08	
	16	8,17	2,26	
	20	6,73	2,53	
	25	5,03	2,96	
	32	3,92	3,44	
	40	/	/	
	50	2,22	3,57	
	63	1,71	4,59	
	D	0,5	/	/
		1	1183	1,55
		1,6	/	/
2		303	1,58	
3		135	1,52	
4		81,8	1,66	
6		40,0	1,78	
10		17,3	1,57	
13		11,3	2,04	
16		8,59	2,31	
20		7,17	2,73	
25		4,77	2,91	
32		3,92	3,44	
40		/	/	
50	/	/		
63	/	/		

Selectivity

ETIMAT	gG NV											
	20	25	32	35	40	50	63	80	100	125	160	
B 6	0,5	0,78	1,2	1,4	1,7	2,4	4,6	7,0	10	10	10	
B 10/13	0,45	0,65	1,1	1,3	1,6	2,2	4,0	6,5	10	10	10	
B 16		0,55	1,0	1,2	1,5	2,0	3,6	5,5	9,5	10	10	
B 20			0,85	1,2	1,5	1,8	3,1	4,6	9,0	10	10	
B 25				1,1	1,4	1,7	2,9	4,0	8,0	10	10	
B 32					1,3	1,6	2,5	3,4	5,5	9,0	10	
B 40						1,5	2,2	3,1	4,9	8,0	10	
B 50							2,1	2,9	4,0	6,2	10	
B 63								2,5	3,3	5,1	8,0	
ETIMAT	gG NV											
	20	25	32	35	40	50	63	80	100	125	160	
	C,D,K,Z 6	0,52	0,82	1,3	1,5	2,0	2,7	5,1	9,0	10	10	10
	C,D,K,Z 10/13	0,47	0,70	1,1	1,4	1,8	2,3	4,0	7,0	10	10	10
	C,D,K,Z 16		0,61	0,92	1,2	1,5	1,9	3,2	5,0	9,0	10	10
	C,D,K,Z 20			0,90	1,1	1,4	1,7	2,9	4,2	8,0	10	10
	C,D,K,Z 25				1,0	1,3	1,6	2,7	3,9	6,0	10	10
	C,D,K,Z 32					1,2	1,5	2,3	3,4	5,2	9,0	10
	C,D 40						1,4	2,1	3,0	4,6	8,0	10
	C,D 50							2,0	2,7	3,8	7,0	10
	C 63								2,3	3,2	5,5	9,0

R: measured at 0.1*In
P: measured at In

Effect of number of poles on the tripping characteristic ETIMAT P10 and P10 Reset

Correction factor K_n

Number of devices	K_n
1	1
2	0,95
3	0,91
4	0,87
5	0,84
6	0,81
7	0,79
8	0,78
9	0,77
>9	0,77

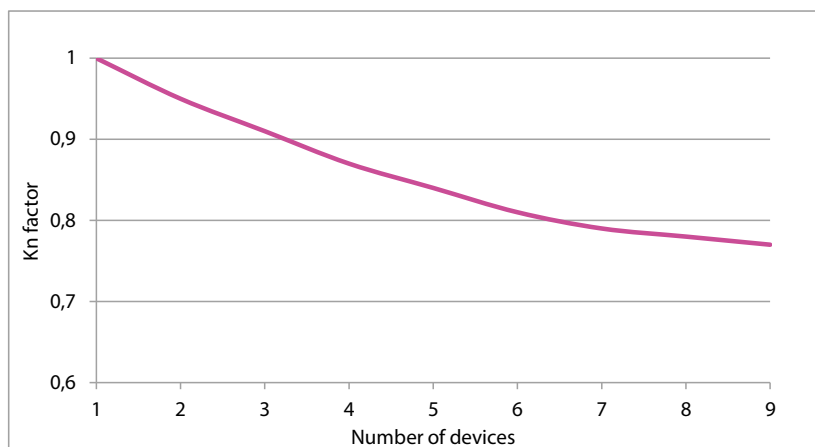

ASTI / Miniature Circuit Breakers

Conductor cross-section [mm ²]	Number of single conductors, rigid, single-wire CU conductor				
	1	2	3	4	5
1,5	✓	✓	✓	✓	✗
2,5	✓	✓	✓	✗	✗
4	✓	✓	✓	✗	✗
6	✓	✓	✗	✗	✗
10	✓	✓	✗	✗	✗
16	✓	✗	✗	✗	✗
25	✓	✗	✗	✗	✗

Remark: When you use more than 2 cables you have to be careful how those cables are inserted to ensure proper pressure on each cable

Conductor cross-section [mm ²]	Number of single conductors, flexible Cu conductors with cable ferrule					
	1	2	3	4	5	6
1,5	✓	✓	✓	✓	✓	✓
2,5	✓	✓	✓	✓	✓	✓
4	✓	✓	✓	✓	✓	✓
6	✓	✓	✓	✗	✗	✗
10	✓	✓	✗	✗	✗	✗
16	✓	✗	✗	✗	✗	✗
25	✓	✗	✗	✗	✗	✗

Combination of rigid single-wire and flexible multi-wire Cu conductors is not allowed

Time current characteristics I/t at 50 and 60Hz, ETIMAT P10 and P10 Reset

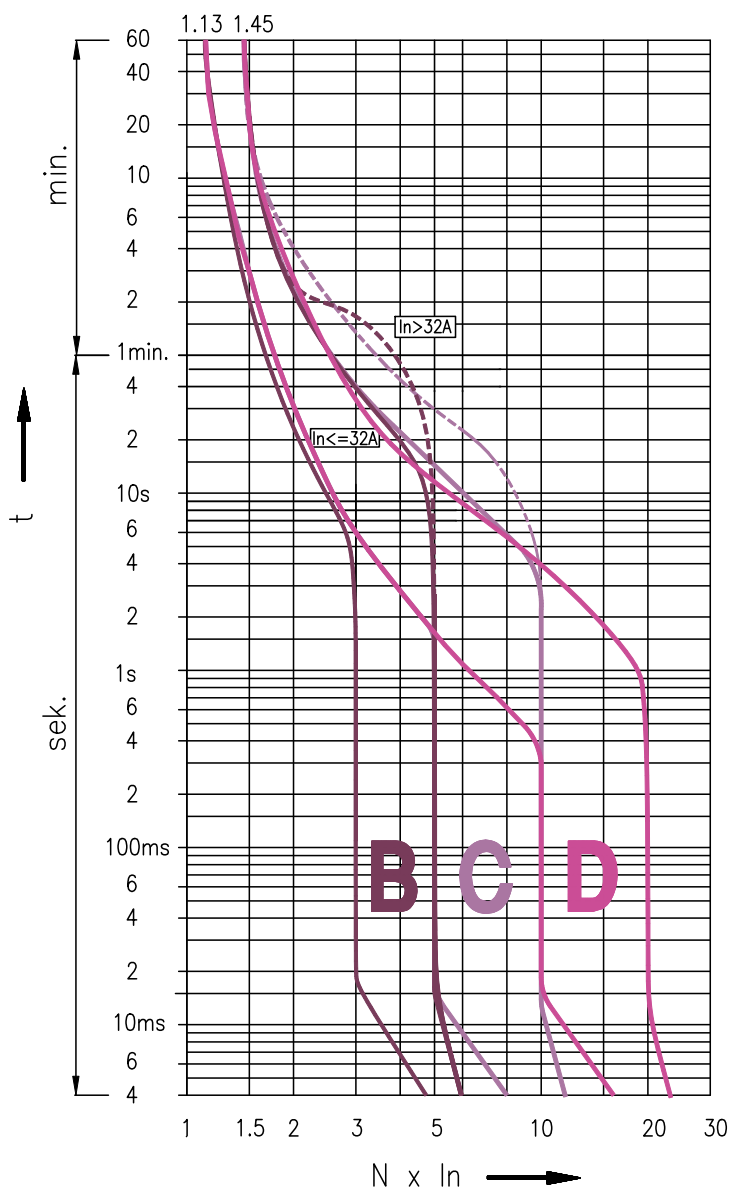

Time current characteristics I/t at 50 and 60Hz, ETIMAT P10 and P10 Reset

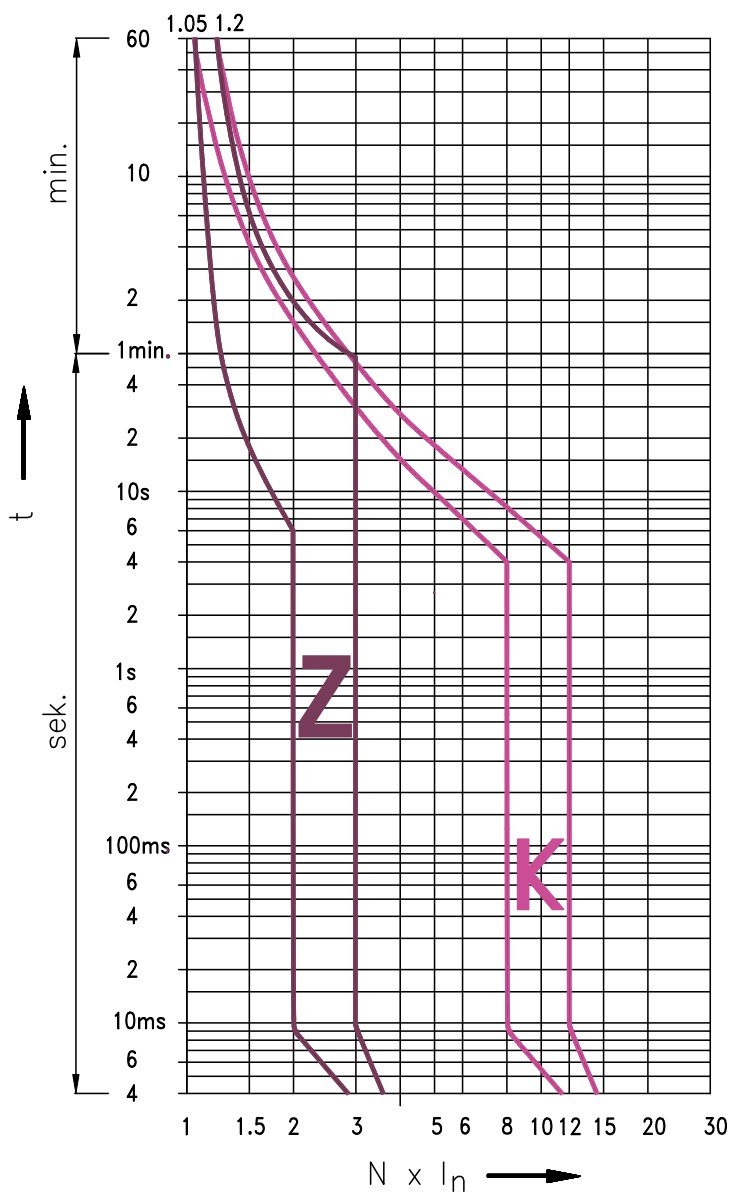

Melting energy characteristics I²t ETIMAT P10 and P10 Reset

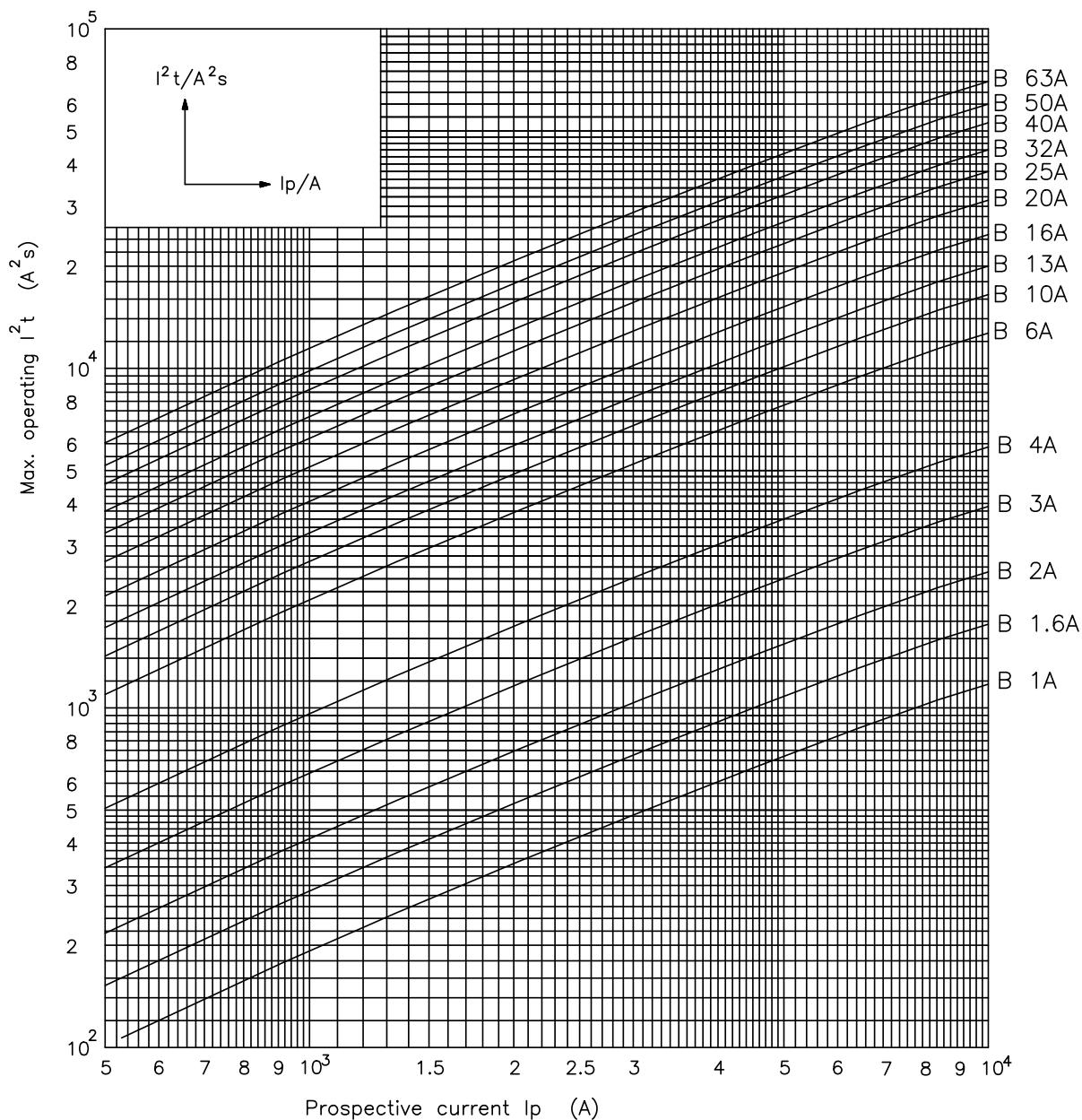

Melting energy characteristics I²t ETIMAT P10 and P10 Reset

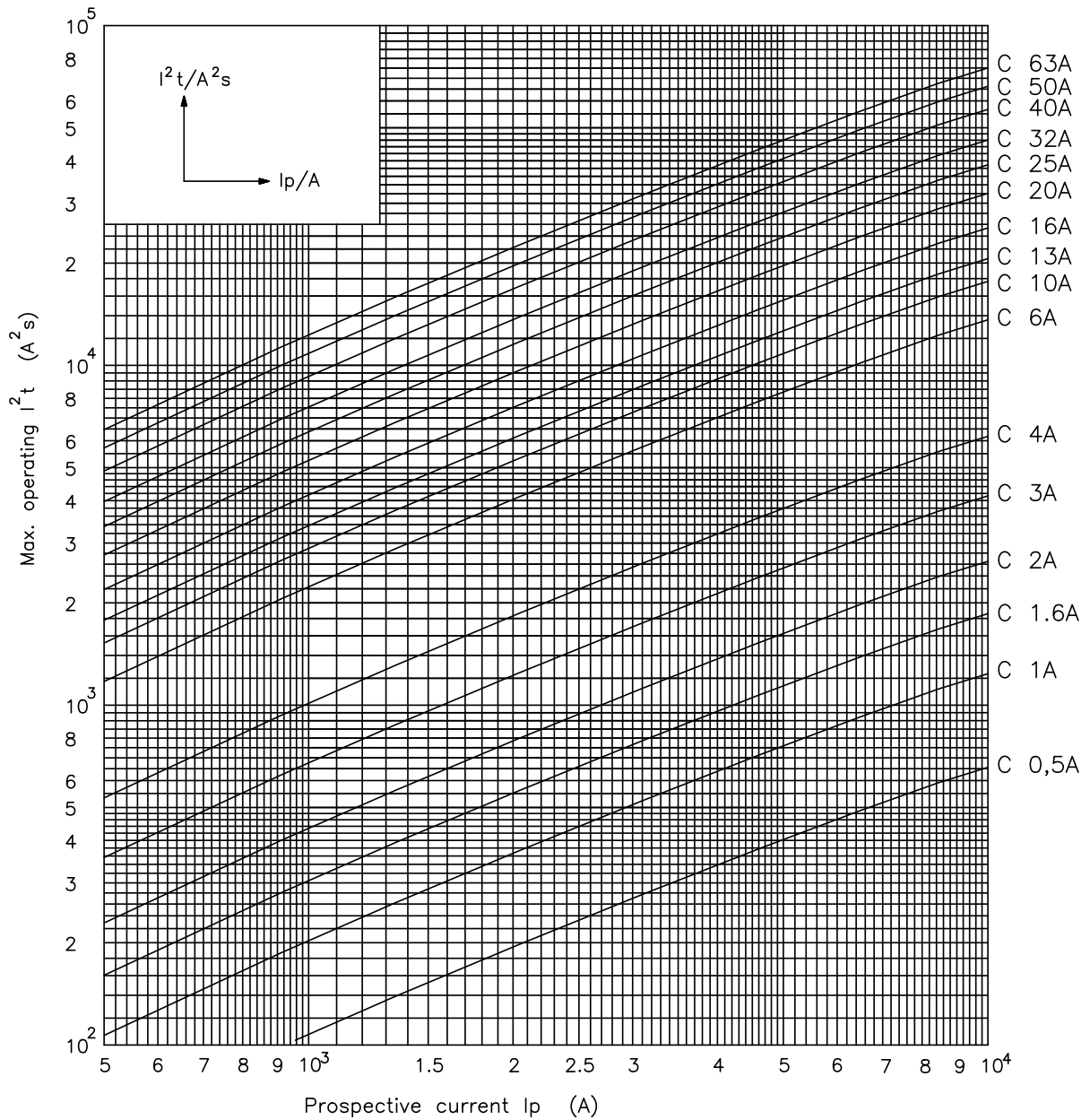

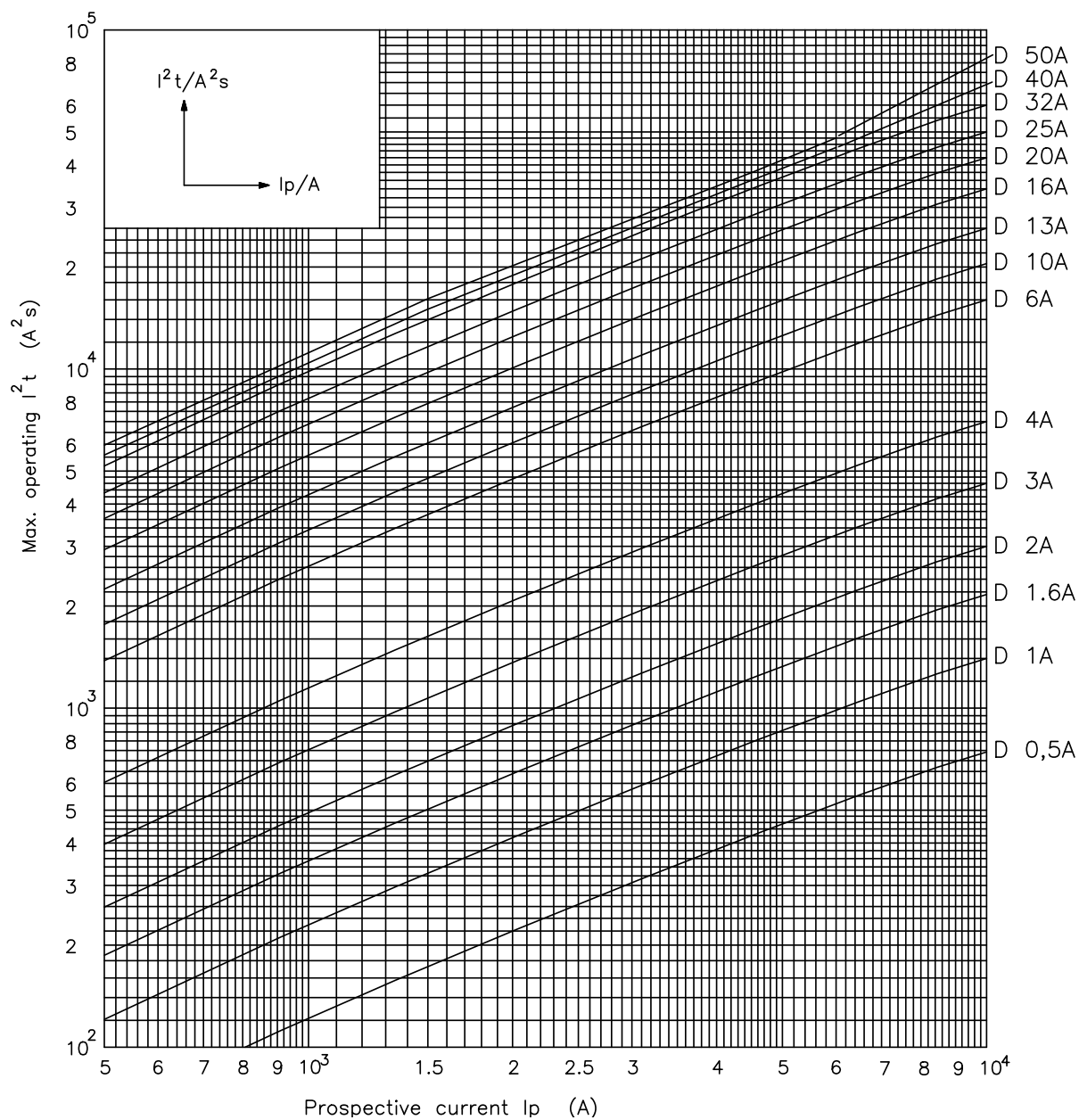
Melting energy characteristics I^2t ETIMAT P10 and P10 Reset

Melting energy characteristics I²t ETIMAT P10 and P10 Reset

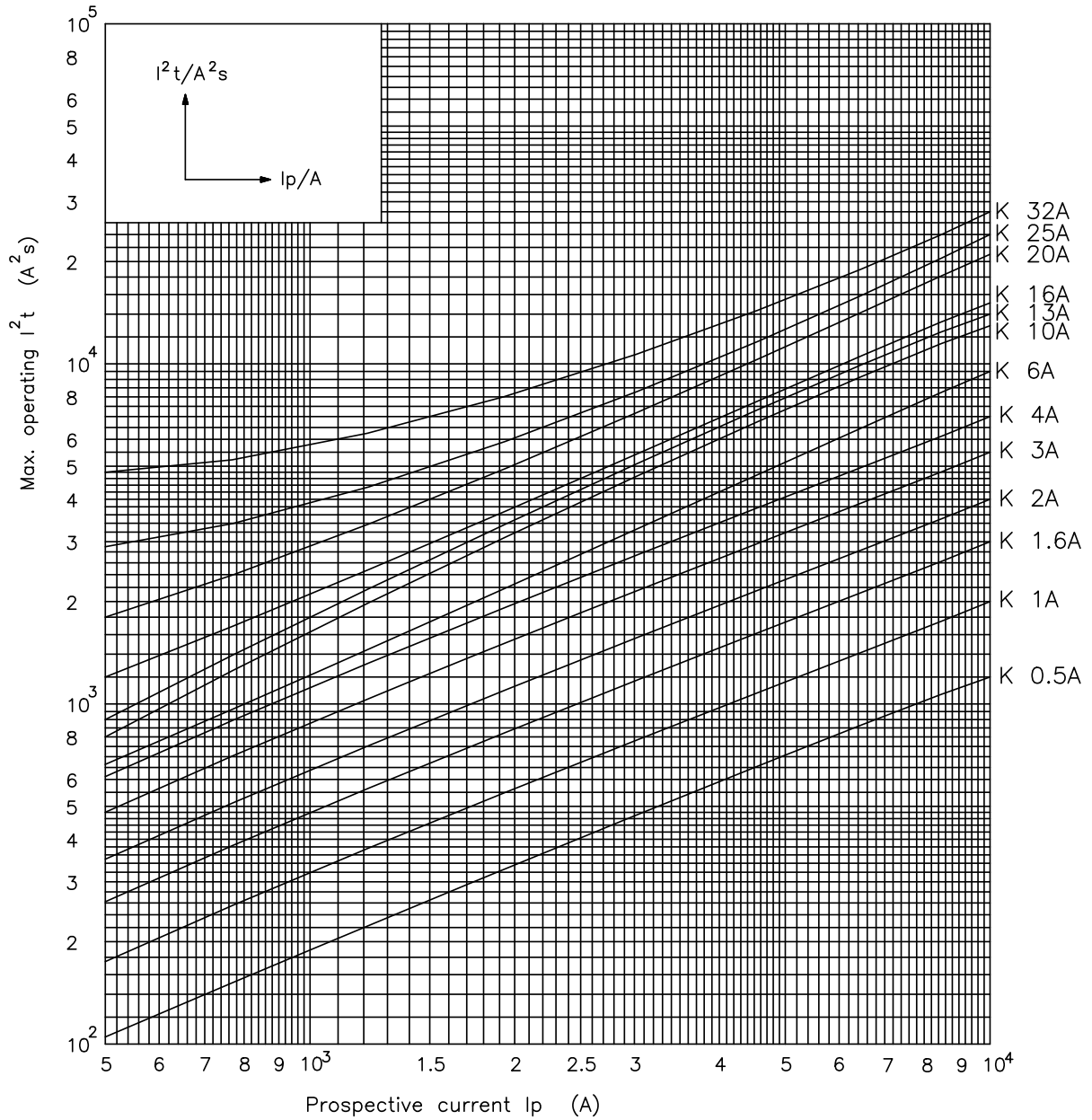

Cut-off characteristics I²t ETIMAT P10 and P10 Reset

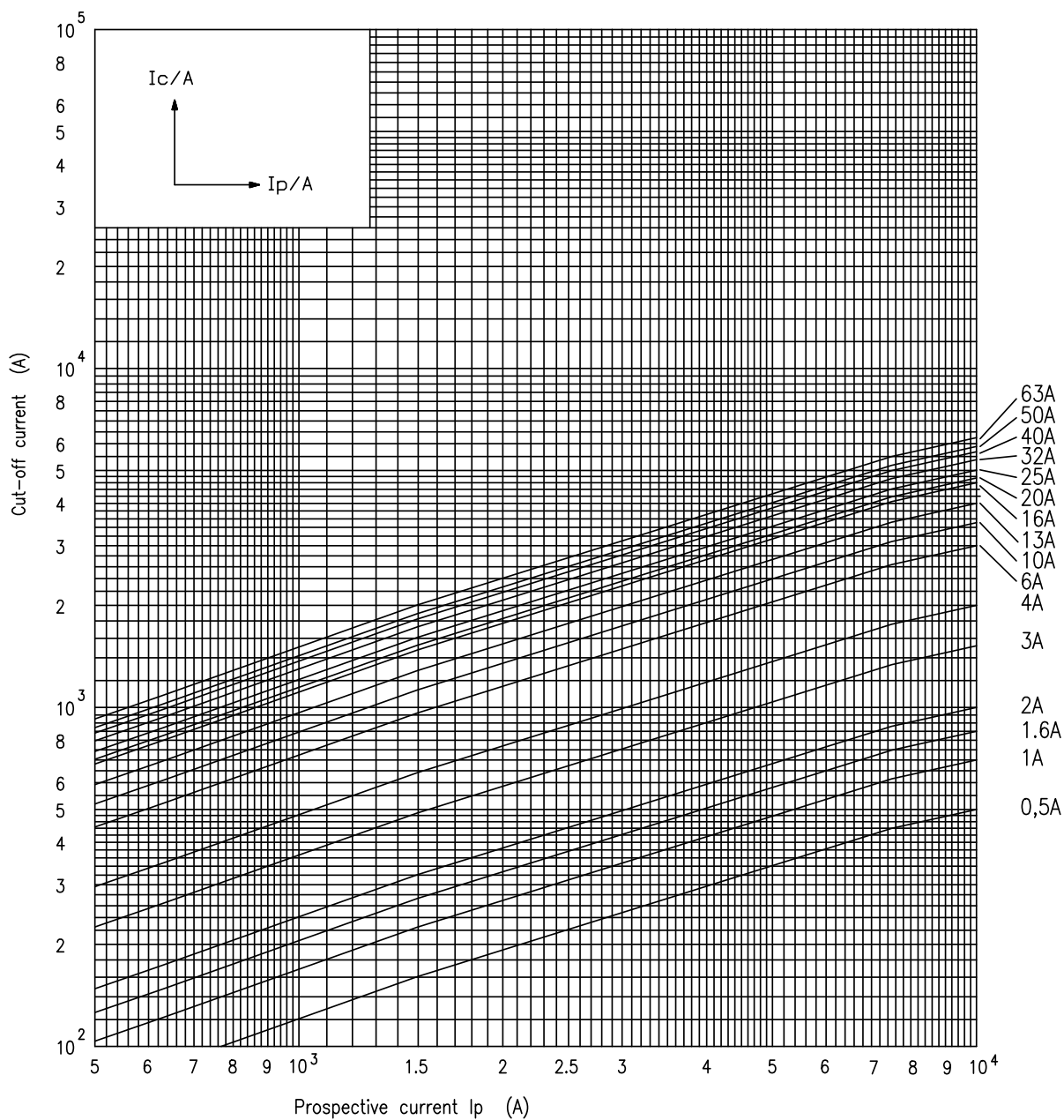

Miniature circuit breaker ETIMAT P10-DC

Rated short-circuit capacity
10 kA

Rated current
0,5 - 63 A

Tripping characteristic
B, C, K, Z



Application: Miniature circuit breakers ETIMAT DC are used for protection of conductors in direct current electric circuits. 1-pole circuit breakers are used for voltages up to 220 V d.c., while 2-pole circuit breakers with poles connected in a series are used for higher voltages (up to 440 V d.c.). When connecting the MCB ETIMAT DC, attention must be paid to polarity as connected in a wrong way the MCB can be destroyed. Note that two 1-pole MCBs cannot be used instead of one 2-pole MCB.

Technical data

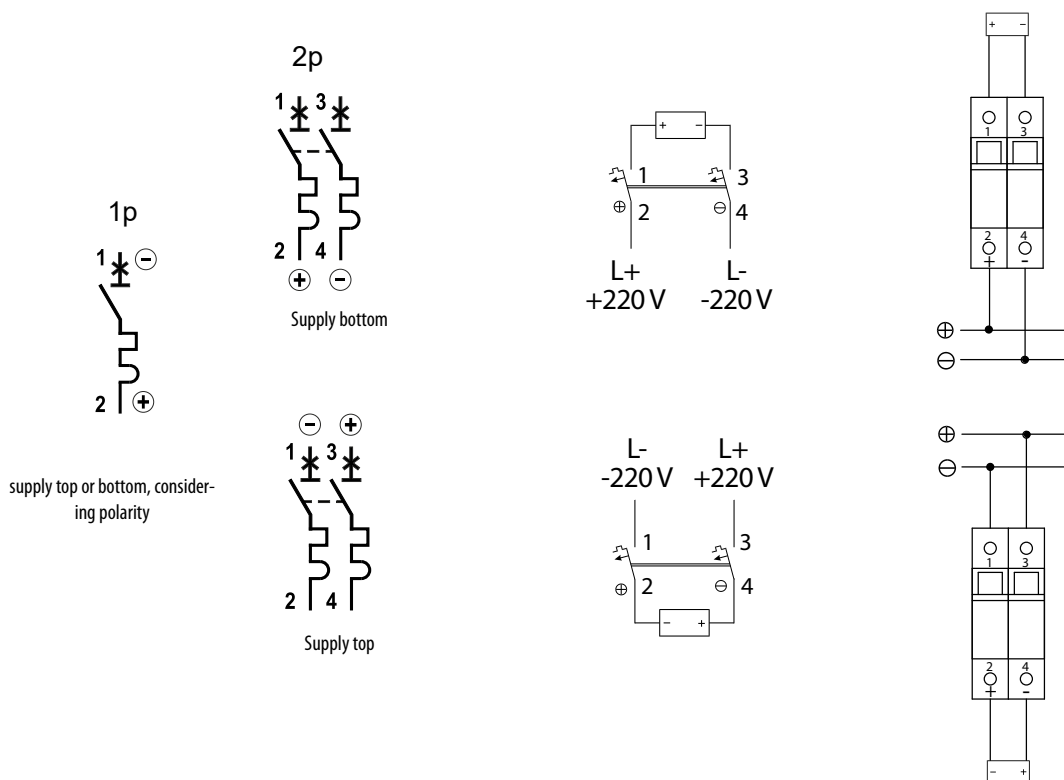
Rated voltage - for 1-pole U_n - for 2-pole U_n	220 V DC 220 V / 440 V DC
Rated time constant L/R	4 ms
Rated current I_n	0,5-32A (K & Z), 0,5-63A (C), 2-63A (B)
Rated short-circuit capacity	10 kA
Tripping characteristic	B, C, K, Z
Energy limiting class	3
Insulating class	B
Pollution degree	2
Back-up fuse	100 A gG
Ambient temperature	-40°C ... +70°C
Storage temperature	-60°C ... +70°C
Terminals	1-25mm ² , min 1,4Nm / max 2,5Nm
Terminal screw	M5 (Pozidrive PZ2)
Mounting position	any
Sealing possibility	✓
Terminal cover	✓
Contact position indicator	✓
Locking device	✓
Resistance to vibrations (IEC 60068-2-7)	5g (10,60 & 500Hz)
Standards	IEC 60898, EN 60898, DIN VDE 0641





1-pole, characteristic B, C



I_n [A]	U_n [V]	Type B	Code No. B	Type C	Code No. C		
0,5	/	/	/	ETIMAT P10-DC 1p C0,5	001903021	94	12/108
1		ETIMAT P10-DC 1p B1	001903002	ETIMAT P10-DC 1p C1	001903022	94	12/108
1,6		ETIMAT P10-DC 1p B1,6	001903003	ETIMAT P10-DC 1p C1,6	001903023	94	12/108
2		ETIMAT P10-DC 1p B2	001903004	ETIMAT P10-DC 1p C2	001903024	94	12/108
3		ETIMAT P10-DC 1p B3	001903005	ETIMAT P10-DC 1p C3	001903025	94	12/108
4		ETIMAT P10-DC 1p B4	001903006	ETIMAT P10-DC 1p C4	001903026	94	12/108
6		ETIMAT P10-DC 1p B6	001903007	ETIMAT P10-DC 1p C6	001903027	94	12/108
10	220	ETIMAT P10-DC 1p B10	001903008	ETIMAT P10-DC 1p C10	001903028	94	12/108
13		ETIMAT P10-DC 1p B13	001903009	ETIMAT P10-DC 1p C13	001903029	94	12/108
16		ETIMAT P10-DC 1p B16	001903010	ETIMAT P10-DC 1p C16	001903030	94	12/108
20		ETIMAT P10-DC 1p B20	001903011	ETIMAT P10-DC 1p C20	001903031	94	12/108
25		ETIMAT P10-DC 1p B25	001903012	ETIMAT P10-DC 1p C25	001903032	95	12/108
32		ETIMAT P10-DC 1p B32	001903013	ETIMAT P10-DC 1p C32	001903033	95	12/108
40		ETIMAT P10-DC 1p B40	001903014	ETIMAT P10-DC 1p C40	001903034	95	12/108
50		ETIMAT P10-DC 1p B50	001903015	ETIMAT P10-DC 1p C50	001903035	103	12/108
63	ETIMAT P10-DC 1p B63	001903016	ETIMAT P10-DC 1p C63	001903036	106	12/108	



1-pole, characteristic K, Z



I_n [A]	U_n [V]	Type K	Code No. K	Type Z	Code No. Z		
0,5		ETIMAT P10-DC 1p K0,5	001903061	ETIMAT P10-DC 1p Z0,5	001903081	94	12/108
1		ETIMAT P10-DC 1p K1	001903062	ETIMAT P10-DC 1p Z1	001903082	94	12/108
1,6		ETIMAT P10-DC 1p K1,6	001903063	ETIMAT P10-DC 1p Z1,6	001903083	94	12/108
2		ETIMAT P10-DC 1p K2	001903064	ETIMAT P10-DC 1p Z2	001903084	94	12/108
3		ETIMAT P10-DC 1p K3	001903065	ETIMAT P10-DC 1p Z3	001903085	94	12/108
4		ETIMAT P10-DC 1p K4	001903066	ETIMAT P10-DC 1p Z4	001903086	94	12/108
6	220	ETIMAT P10-DC 1p K6	001903067	ETIMAT P10-DC 1p Z6	001903087	94	12/108
10		ETIMAT P10-DC 1p K10	001903068	ETIMAT P10-DC 1p Z10	001903088	94	12/108
13		ETIMAT P10-DC 1p K13	001903069	ETIMAT P10-DC 1p Z13	001903089	94	12/108
16		ETIMAT P10-DC 1p K16	001903070	ETIMAT P10-DC 1p Z16	001903090	94	12/108
20		ETIMAT P10-DC 1p K20	001903071	ETIMAT P10-DC 1p Z20	001903091	94	12/108
25		ETIMAT P10-DC 1p K25	001903072	ETIMAT P10-DC 1p Z25	001903092	95	12/108
32		ETIMAT P10-DC 1p K32	001903073	ETIMAT P10-DC 1p Z32	001903093	95	12/108

2-pole, characteristic B, C

I_n [A]	U_n [V]	Type B	Code No. B	Type C	Code No. C		
0,5	/	/	/	ETIMAT P10-DC 2p C0,5	001903221	190	6/54
1		ETIMAT P10-DC 2p B1	001903202	ETIMAT P10-DC 2p C1	001903222	190	6/54
1,6		ETIMAT P10-DC 2p B1,6	001903203	ETIMAT P10-DC 2p C1,6	001903223	190	6/54
2		ETIMAT P10-DC 2p B2	001903204	ETIMAT P10-DC 2p C2	001903224	190	6/54
3		ETIMAT P10-DC 2p B3	001903205	ETIMAT P10-DC 2p C3	001903225	190	6/54
4		ETIMAT P10-DC 2p B4	001903206	ETIMAT P10-DC 2p C4	001903226	190	6/54
6		ETIMAT P10-DC 2p B6	001903207	ETIMAT P10-DC 2p C6	001903227	190	6/54
10	440	ETIMAT P10-DC 2p B10	001903208	ETIMAT P10-DC 2p C10	001903228	190	6/54
13		ETIMAT P10-DC 2p B13	001903209	ETIMAT P10-DC 2p C13	001903229	190	6/54
16		ETIMAT P10-DC 2p B16	001903210	ETIMAT P10-DC 2p C16	001903230	190	6/54
20		ETIMAT P10-DC 2p B20	001903211	ETIMAT P10-DC 2p C20	001903231	190	6/54
25		ETIMAT P10-DC 2p B25	001903212	ETIMAT P10-DC 2p C25	001903232	193	6/54
32		ETIMAT P10-DC 2p B32	001903213	ETIMAT P10-DC 2p C32	001903233	193	6/54
40		ETIMAT P10-DC 2p B40	001903214	ETIMAT P10-DC 2p C40	001903234	193	6/54
50		ETIMAT P10-DC 2p B50	001903215	ETIMAT P10-DC 2p C50	001903235	208	6/54
63	ETIMAT P10-DC 2p B63	001903216	ETIMAT P10-DC 2p C63	001903236	215	6/54	



2-pole, characteristic K, Z

I_n [A]	U_n [V]	Type K	Code No. K	Type Z	Code No. Z	 g	
0,5	440	ETIMAT P10-DC 2p K0,5	001903261	ETIMAT P10-DC 2p Z0,5	001903281	190	6/54
1		ETIMAT P10-DC 2p K1	001903262	ETIMAT P10-DC 2p Z1	001903282	190	6/54
1,6		ETIMAT P10-DC 2p K1,6	001903263	ETIMAT P10-DC 2p Z1,6	001903283	190	6/54
2		ETIMAT P10-DC 2p K2	001903264	ETIMAT P10-DC 2p Z2	001903284	190	6/54
3		ETIMAT P10-DC 2p K3	001903265	ETIMAT P10-DC 2p Z3	001903285	190	6/54
4		ETIMAT P10-DC 2p K4	001903266	ETIMAT P10-DC 2p Z4	001903286	190	6/54
6		ETIMAT P10-DC 2p K6	001903267	ETIMAT P10-DC 2p Z6	001903287	190	6/54
10		ETIMAT P10-DC 2p K10	001903268	ETIMAT P10-DC 2p Z10	001903288	190	6/54
13		ETIMAT P10-DC 2p K13	001903269	ETIMAT P10-DC 2p Z13	001903289	190	6/54
16		ETIMAT P10-DC 2p K16	001903270	ETIMAT P10-DC 2p Z16	001903290	190	6/54
20		ETIMAT P10-DC 2p K20	001903271	ETIMAT P10-DC 2p Z20	001903291	190	6/54
25		ETIMAT P10-DC 2p K25	001903272	ETIMAT P10-DC 2p Z25	001903292	193	6/54
32		ETIMAT P10-DC 2p K32	001903273	ETIMAT P10-DC 2p Z32	001903293	193	6/54

Connecting diagrams in direct current electric circuits

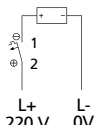
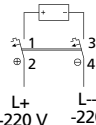
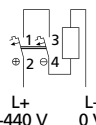
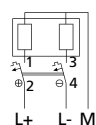
Rated voltage of circuit breaker	220 V ---	220/440 V ---	220/440 V ---	220/440 V ---
Voltage between conductors - max.	220 V ---	440 V ---	440 V ---	440 V ---
Voltage between conductor and earth - max.	220 V ---	220 V ---	440 V ---	220 V ---
Circuit breaker	1-pole	2-pole	2-pole	2-pole
Connecting diagram				

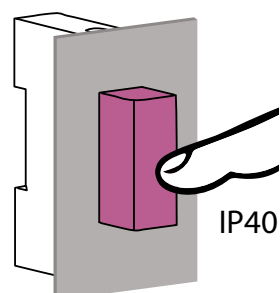
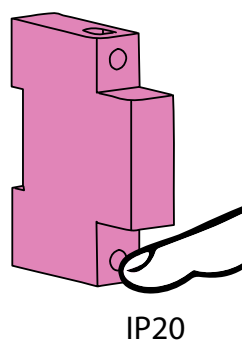
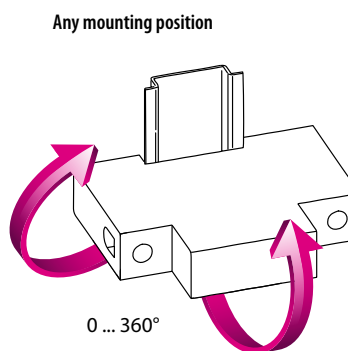
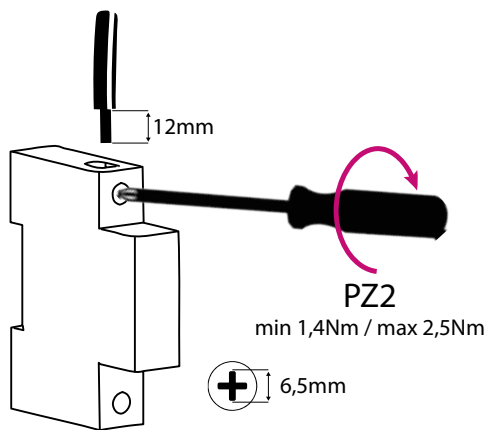

Time current characteristics I/t, ETIMAT P10-DC

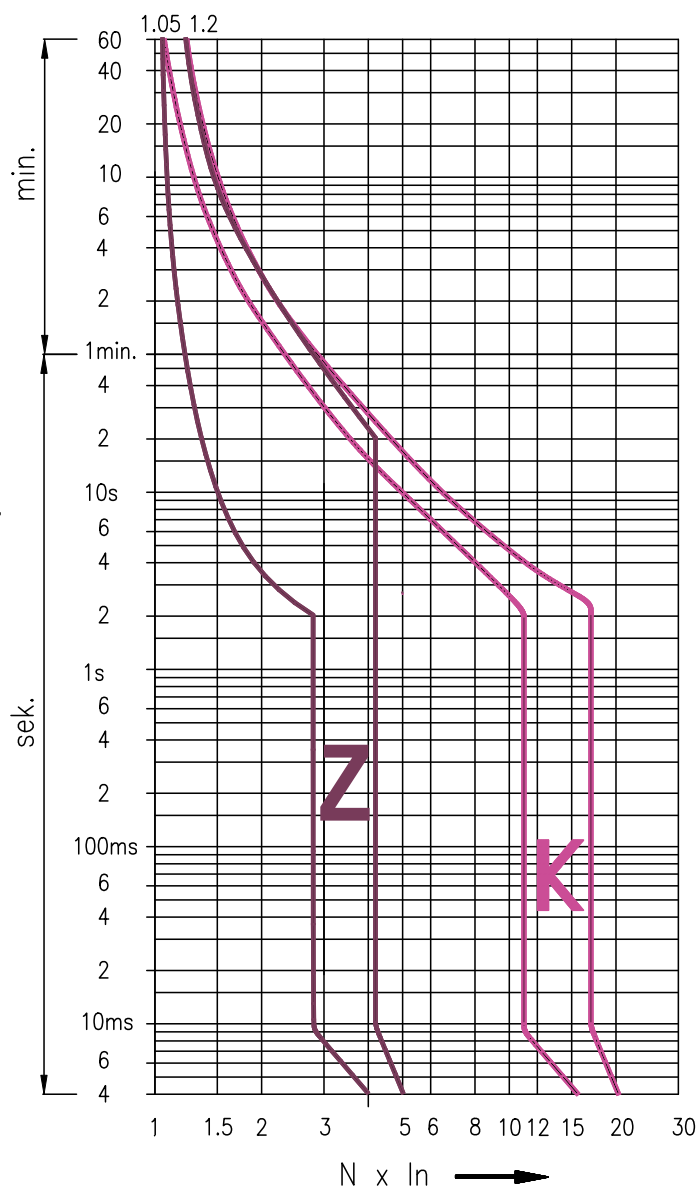
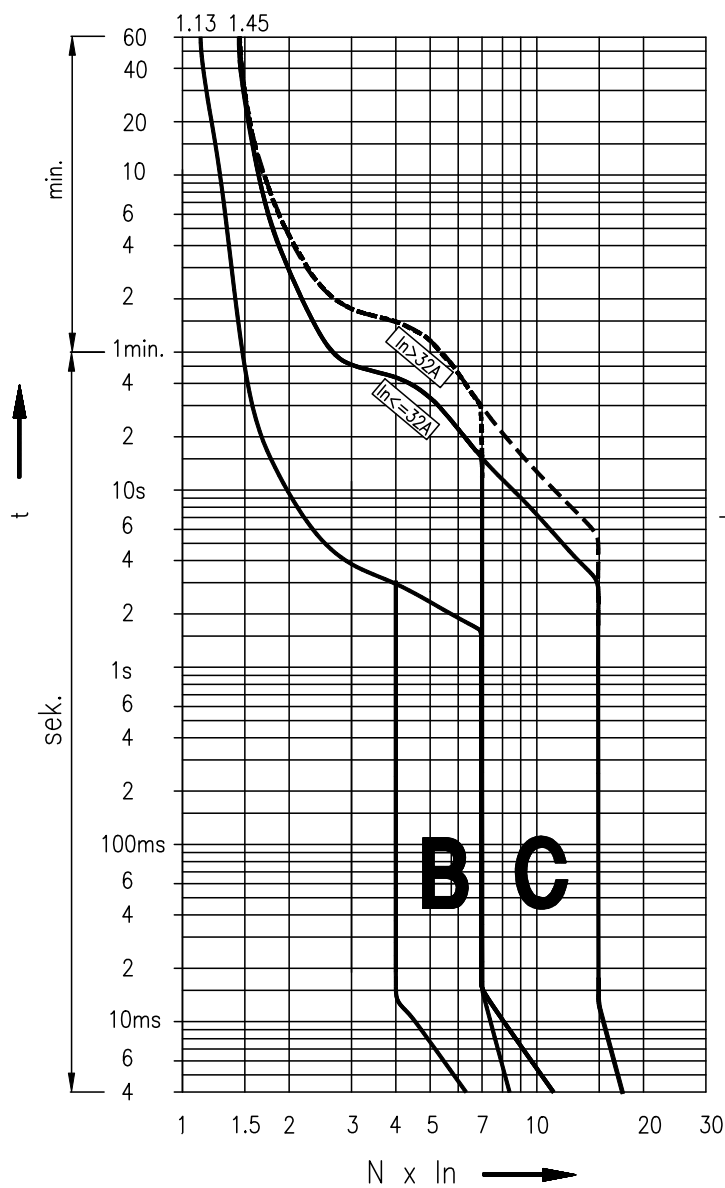

Conductor cross-section [mm ²]	Number of single conductors, rigid, single-wire CU conductor				
	1	2	3	4	5
1,5	✓	✓	✓	✓	✗
2,5	✓	✓	✓	✗	✗
4	✓	✓	✓	✗	✗
6	✓	✓	✗	✗	✗
10	✓	✓	✗	✗	✗
16	✓	✗	✗	✗	✗
25	✓	✗	✗	✗	✗



Remark: When you use more than 2 cables you have to be careful how those cables are inserted to ensure proper pressure on each cable

Conductor cross-section [mm ²]	Number of single conductors, flexible Cu conductors with cable ferrule					
	1	2	3	4	5	6
1,5	✓	✓	✓	✓	✓	✓
2,5	✓	✓	✓	✓	✓	✓
4	✓	✓	✓	✓	✓	✓
6	✓	✓	✓	✗	✗	✗
10	✓	✓	✗	✗	✗	✗
16	✓	✗	✗	✗	✗	✗
25	✓	✗	✗	✗	✗	✗



Combination of rigid single-wire and flexible multi-wire Cu conductors is not allowed

Accessories for ETIMAT P6, ETIMAT P10(/R) and ETIMAT P10-DC



ETIMAT terminal cover

Code No.		
002159011	2	12

Sealing piece ETIMAT

Code No.		
001908405	2	12

Locking device

Code No.		
001908401	3	1/1



The PS/SS ETIMAT P6/P10 is an auxiliary/signal switch designed for remote signalling. It is used in conjunction with the MCB, to which it is attached on the left side. Although the PS/SS ETIMAT P6/P10 can be fixed initially, it may also be attached at a later stage. The clamps on the device are safe to touch. Its external dimensions are consistent with the MCB, and its built-in width measures 0.5 module (9 mm).



During installation, ensure that the MCB is switched off. The package for the PS/SS ETIMAT P6/P10 includes connection springs if you're using only one PS/SS. However, up to three PS/SS can be fitted to the ETIMAT P6/P10 using special connection springs.

Technical data

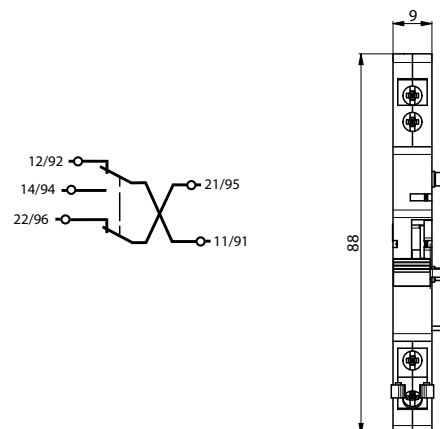

Function	Auxiliary or Signal Switch
Rated voltage	230V AC/DC, 110V DC
Rated current	6A (230V AC); 1A (110V DC); 0,5A (220V DC)
Rated frequency	50/60Hz, DC
Index of protection	IP 20 (IP 40)
Terminal capacity	1,5mm ²
Terminal Screw	M3 PH1
Terminal torque	max. 0,5Nm
Ambient temperature	-25°C... +40°C
Storage temperature	-40°C... +70°C
Contacts	1x NC, 1x NC/NO
Mounting position	any
Standards	EN 62019



Auxiliary / signal switch PS/SS ETIMAT P6/P10

Type	Code No.	contacts		
PS/SS ETIMAT P6/P10	001908421	1xNC, 1xNC/NO	53	1/12

Connection spring for 2x and 3x PS/SS

Type	Code No.		
ETIMAT P10 2xPS/SS	027324022	3,7	10
ETIMAT P10 3xPS/SS	027324023	4,5	10



ASTI / Miniature Circuit Breakers

AUX switch connections	status of the breaker	
	ON	OFF
11-14 NO	1	0
11-12 NC	0	1
21-22 NC	0	1

Signal switch connections	status of the breaker		
	ON	manual trip	overcurrent trip
11-14 NO	1	1	0
11-12 NC	0	0	1
21-22 NC	0	0	1

NO - Normally open contact --> during the activation it makes a contact
 NC - Normally closed contact --> during the activation it brakes the contact
 1 - contact
 0 - without a contact

Installation instructions

WARNING: Do not install three auxiliary/signal switches on a single-pole MCB.

1. Before adding the switch, first remove the connection spring (Fig. 1).
2. Adjust the contact position based on the desired function, using the rotary switch as per the markings (Fig. 2).
3. When utilizing two or three auxiliary/signal switches, ensure the function selection matches the guides in Fig. 9 or Fig. 13, respectively.
4. For installations involving two or three additional auxiliary/signal switches, break the plastic windows on their housings, except for the outermost one (Fig. 7, Fig. 11).
5. If breaking the plastic window on the switch, ensure that no fragments enter the body of the switch (Fig. 3).
6. Connect the auxiliary/signal switches to the MCB (Fig. 4, Fig. 8, Fig. 12).
7. Secure the auxiliary/signal switches in place using appropriately sized connection springs (Fig. 5, Fig. 10, Fig. 14). Note: These connection springs are not included in the delivery set.
8. To test the additional auxiliary/signal switches (PS/SS), use a screwdriver to press the triggering mechanism in the "TEST" window of the switch (Fig. 6). Ensure the handle is set to the "ON" position.

Installation of one PS/SS ETIMAT P6/P10 switch

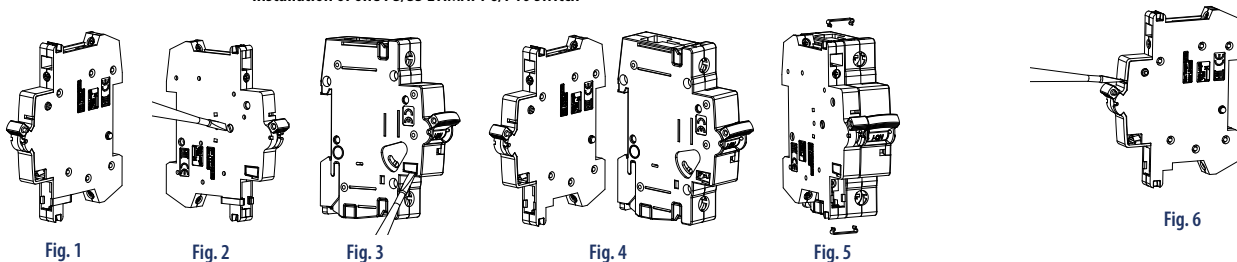

Installation of two PS/SS ETIMAT P6/P10 switches

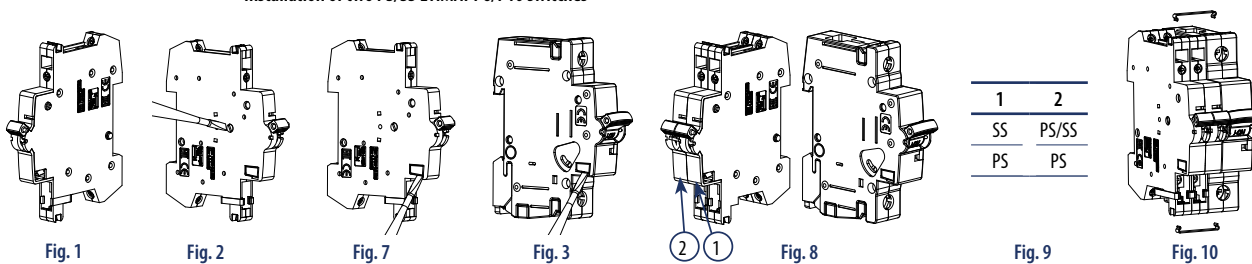

Installation of three PS/SS ETIMAT P6/P10 switches

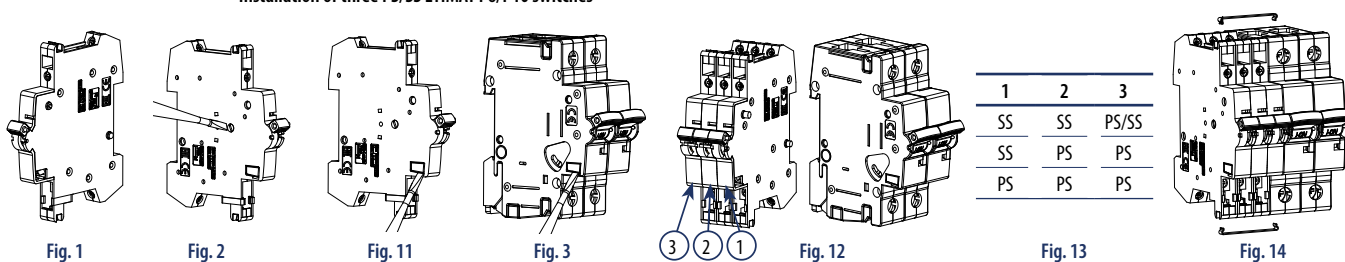

DA ETIMAT P6/P10 shunt trip release is fixed to the right side of the miniature circuit breaker ETIMAT P6/P10 for remote release of the MCB. Dimensions correspond to those of MCB ETIMAT P6/P10.

Technical data

Rated voltage	12-60V AC/DC, 110-250V AC/DC
Rated frequency	50/60Hz, DC
Max inrush current	3A
Index of protection	IP 20 (IP 40)
Terminals	1-25mm ² , min 1,4Nm / max 2,5Nm
Terminal screw	M5 (Pozidrive PZ2)
Ambient temperature	-40°C ... +70°C
Storage temperature	-60°C ... +70°C
Mounting on the rail	EN 60715
Mounting position	any
Sealing possibility	✓
Terminal cover	✓
Locking device	✓

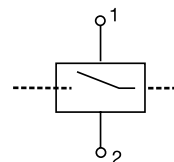

Note: Same dimensions as ETIMAT P10



Shunt trip release DA ETIMAT P6/P10

Type	Code No.		
DA ETIMAT P6/P10 12-60V AC/DC	001908411	110	1/54
DA ETIMAT P6/P10 110-250V AC/DC	001908412	110	1/54
DA ETIMAT P10/R 12-60V AC/DC	001908413	110	1/54
DA ETIMAT P10/R 110-250V AC/DC	001908414	110	1/54

Miniature circuit breaker ETIMAT 10 80 -125A

Rated short-circuit capacity **15, 20 kA** / Rated current **80 - 125 A** / Tripping characteristics **B, C, D**

Technical data

Rated voltage	80-125 A	240/415V AC, 60V DC/pole
Rated current	80, 100, 125 A	
Tripping characteristics	B, C, D	
Rated frequency	50/60 Hz	
Rated insulation voltage	440V AC (80-125A)	
Rated impulse withstand voltage U _{imp}	4kV (80-125A)	
Rated short-circuit capacity:	Characteristic B, C	I _n = 80, 100 A 20kA (EN 60947-2)
		I _n = 125 A 15kA (EN 60947-2)
	Characteristic D	I _n = 80 A 20kA (EN 60947-2)
		I _n = 100 A 15kA (EN 60947-2)
Energy limiting class	3	
Terminals	80-125 A	2,5-50mm ² / 2,5-3,0 Nm
Build-in width	80-125 A	27mm/Pol
Terminal screw	M6 PZ2	
Mounting on the rail	EN 60715 (EN 50022)	
Mounting position	any	
Ambient temperature	max -30°C ... +50°C	
Storage temperature	max -50°C ... +70°C	
Mechanical durability (cycles)	80-125 A	min. 20000
Sealing possibility	ON / OFF	
Back-up fuse	max 200A gL	
Resistance to vibrations (IEC 60068-2-7)	5g (10,60 & 500Hz)	
Standards	EN 60898, EN 60947-2	

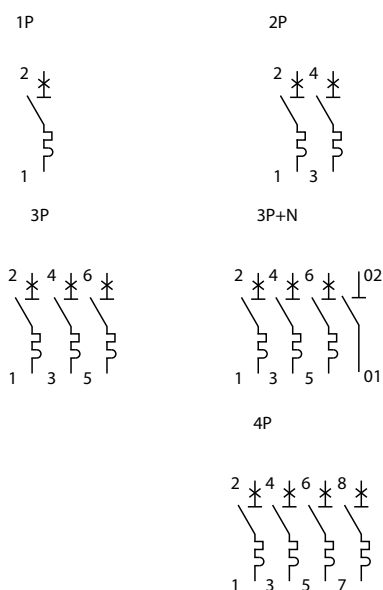

ASTI / Miniature Circuit Breakers

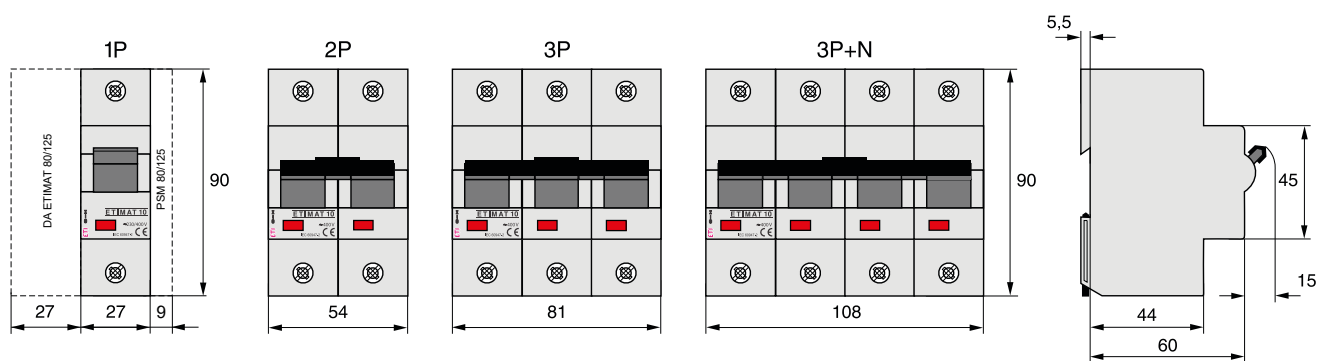
**1-pole**

I_n [A]	Type B	Code No. B	Type C	Code No. C	Type D	Code No. D	g	Box
80	ETIMAT 10 1p B 80	002121731	ETIMAT 10 1p C 80	002131731	ETIMAT 10 1p D 80	002151731	231	2/72
100	ETIMAT 10 1p B 100	002121732	ETIMAT 10 1p C 100	002131732	ETIMAT 10 1p D 100	002151732	231	2/72
125	ETIMAT 10 1p B 125	002121733	ETIMAT 10 1p C 125	002131733	/	/	231	2/72

2-pole

I_n [A]	Type B	Code No. B	Type C	Code No. C	Type D	Code No. D	g	Box
80	ETIMAT 10 2p B 80	002123731	ETIMAT 10 2p C 80	002133731	ETIMAT 10 2p D 80	002153731	466	1/36
100	ETIMAT 10 2p B 100	002123732	ETIMAT 10 2p C 100	002133732	ETIMAT 10 2p D 100	002153732	466	1/36
125	ETIMAT 10 2p B 125	002123733	ETIMAT 10 2p C 125	002133733	/	/	466	1/36

3-pole

I_n [A]	Type B	Code No. B	Type C	Code No. C	Type D	Code No. D	g	Box
80	ETIMAT 10 3p B 80	002125731	ETIMAT 10 3p C 80	002135731	ETIMAT 10 3p D 80	002155731	696	1/18
100	ETIMAT 10 3p B 100	002125732	ETIMAT 10 3p C 100	002135732	ETIMAT 10 3p D 100	002155732	696	1/18
125	ETIMAT 10 3p B 125	002125733	ETIMAT 10 3p C 125	002135733	/	/	696	1/18

3-pole + N

I_n [A]	Type B	Code No. B	Type C	Code No. C	Type D	Code No. D	g	Box
80	ETIMAT 10 3p+N B 80	002126731	ETIMAT 10 3p+N C 80	002136731	ETIMAT 10 3p+N D 80	002156731	860	1/14
100	ETIMAT 10 3p+N B 100	002126732	ETIMAT 10 3p+N C 100	002136732	ETIMAT 10 3p+N D 100	002156732	860	1/14
125	ETIMAT 10 3p+N B 125	002126733	ETIMAT 10 3p+N C 125	002136733	/	/	860	1/14

4-pole

I_n [A]	Type B	Code No. B	Type C	Code No. C	g	Box
80	ETIMAT 10 4p B 80	002127731	ETIMAT 10 4p C 80	002137731	930	1/14
100	ETIMAT 10 4p B 100	002127732	ETIMAT 10 4p C 100	002137732	930	1/14
125	ETIMAT 10 4p B 125	002127733	ETIMAT 10 4p C 125	002137733	930	1/14



Time current characteristics I/t at 50 and 60Hz, ETIMAT 10 80 -125A

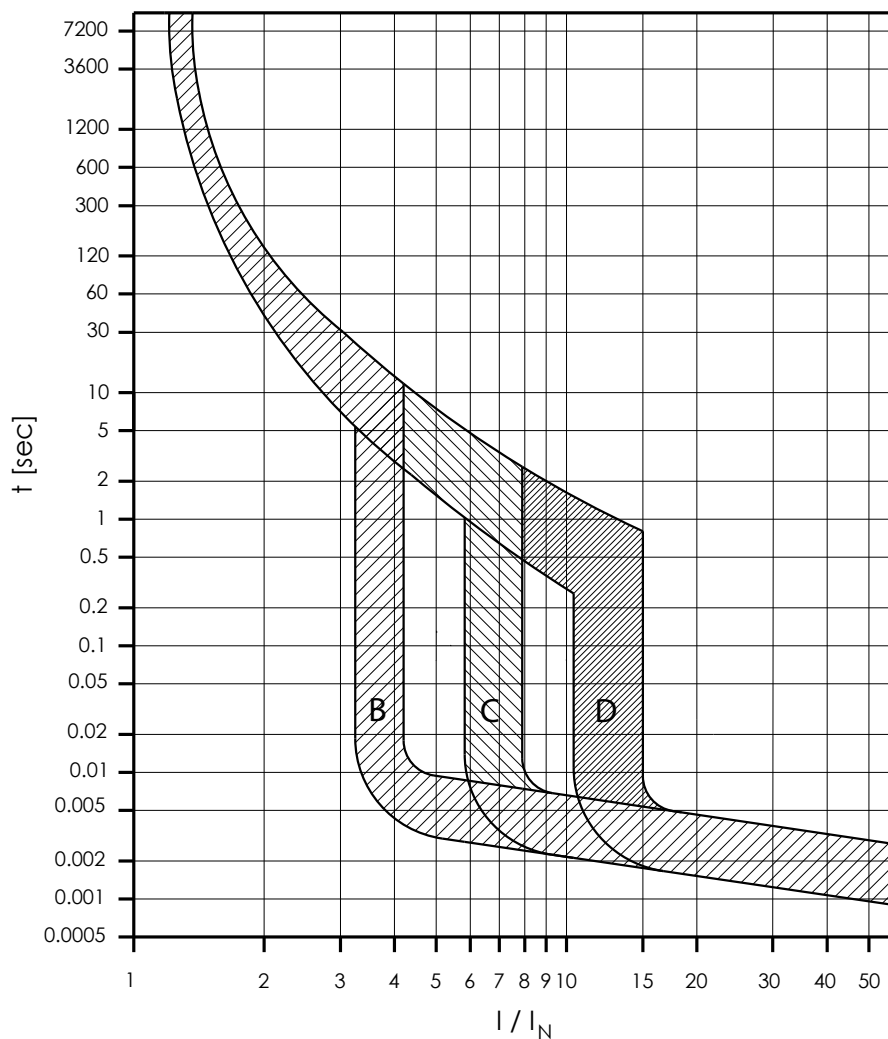

Resistance and power dissipation

characteristic	I_n [A]	R/pole [mΩ]	P/pole [w]
	80	1,2	7,1
B, C, D	100	0,9	9,1
	125	0,66	11,9

Effect of the ambient temperature ($^{\circ}\text{C}$) K_T on the tripping characteristics of ETIMAT 10 80 -125A

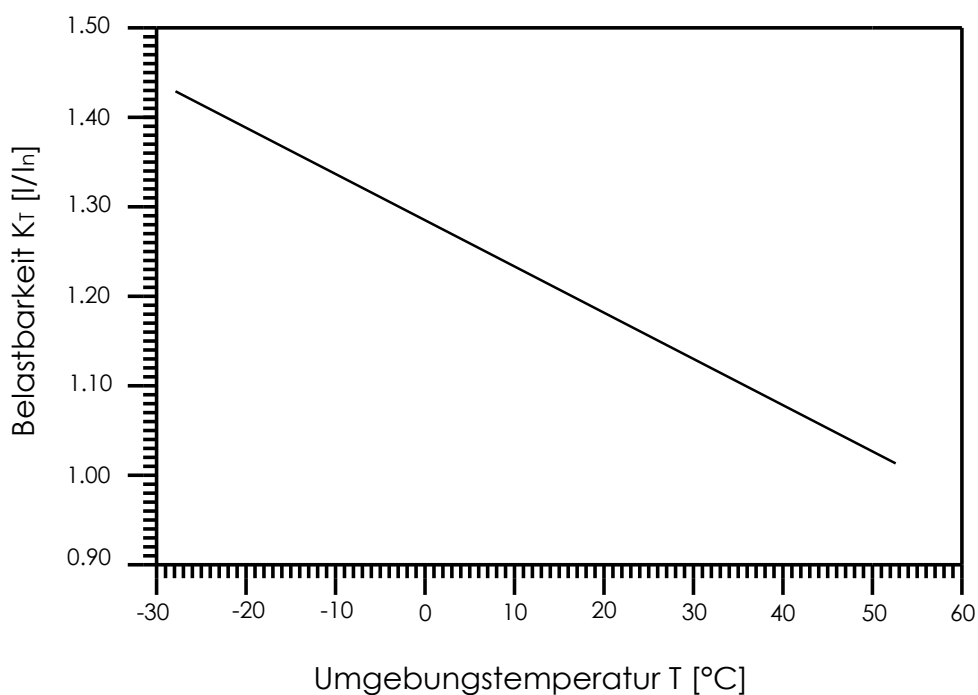

Zulässige Dauerbelastung I_L bei Umgebungstemperatur T: $I_L(T) = I_n K_T(T)$

Accessories for ETIMAT10 80 - 125A

Technical data

Rated current	6 A / AC13 (250 V AC)
Rated thermal current I_{th}	8 A
Rated insulation voltage	440 V AC
Max. back-up fuse	6A
Contacts	1x a-contact, 1x b-contact
Utilization category AC-13	6 A/250 V AC
	2 A/440 V AC
	4 A/600 V DC
Utilization category DC-13	2 A/110 V DC
	0,5 A/230 V DC
	Ambient temperature
Build-in width	9 mm/Pol
Mounting position	any
Mounting on the rail	EN 60715 (EN 50022)
Terminals	1x1mm ² ... 2x2,5mm ²
Standard	EN 60947-5-1

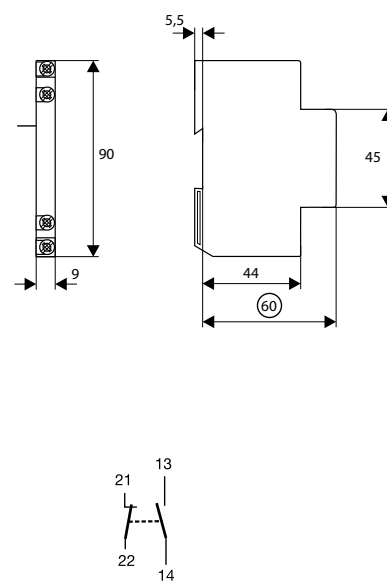

Auxiliary switch PSM 80/125

Type	Code No.		
PSM 80 - 125 A	002159121	62	1/12



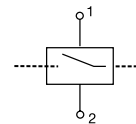
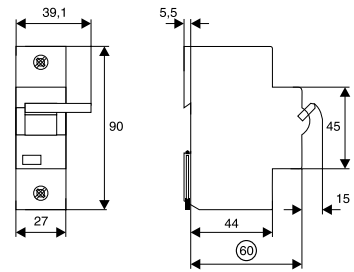

Technical data

	24V	230V
Responding limit	8 V AC / 11 V DC	70 V AC / 90 V DC
Operating voltage range	12 V...60 V AC / DC	110 V...415 V AC / 110 V...230 V DC
Max. current consumption at the moment of switching on	18 A (24 V)	2 A (230 V)
Duration of current flow at max consumption	4,5 ms (AC) / 2 ms (DC)	4,5 ms (AC) / 4 ms (DC)
Minimum pulse duration	15 ms	10 ms
Internal resistance	2,0 Ω	130 Ω
Duty	100 %	
Tripping time	< 20 ms	
Peak withstand voltage	2 kV	
Service live operating cycles	> 4000	
Upper / lower terminals	lift / lift	
Conductor cross section	2,5 mm ² ... 50 mm ²	



Shunt trip release DA ETIMAT 80/125

Type	Code No.		
DA ETIMAT 80/125 12-60V AC/DC	002159320	173	1/54
DA ETIMAT 80/125 110-415V	002159321	173	1/54













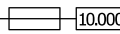







ASTI Residual Current Circuit Breakers - RCCBs





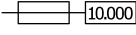

Residual current circuit breakers can be used in TN-S, TN-CS, TT and IT network systems, that is in all systems where neutral and protective conductors are separated. Residual current circuit breakers EFI are used for protection against indirect contact (fault protection) and direct contact (additional protection) of parts under voltage. In the case of protection against indirect contact (fault protection) you can use residual current protective devices with a rated residual current of $I_{\Delta n} \leq 300\text{mA}$. Residual current protective devices with a rated residual current of $I_{\Delta n} \leq 30\text{mA}$ fulfil the conditions for protection against direct contact (additional protection). For protection against fire, according to DIN VDE 0100-482 and IEC 60364-4-482, all cables and conductors in TN and TT systems must be protected by means of residual current protective devices with rated residual current of $I_{\Delta n} \leq 300\text{mA}$. In applications where resistive faults can cause a fire (radiant ceiling heating with panel heating elements), the rated residual current must be $I_{\Delta n} = 30\text{mA}$.

Types



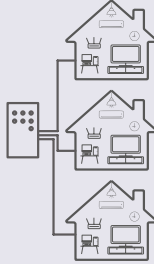

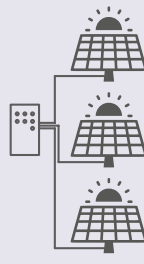
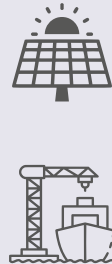
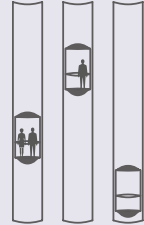





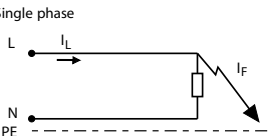
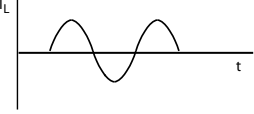
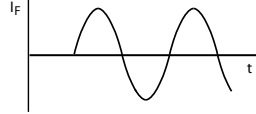
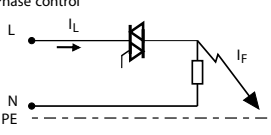
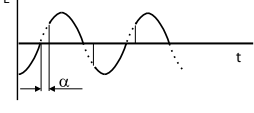
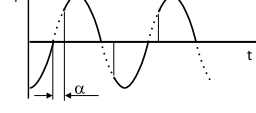
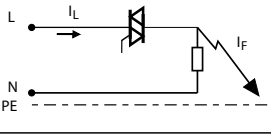
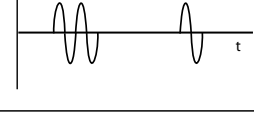

- /// AC Type: they are sensitive to alternating (sinusoidal) AC residual currents.
- /// A Type: they are sensitive to alternating (sinusoidal) AC residual currents and pulsating DC residual currents.
- /// B Type: they are sensitive to alternating (sinusoidal) AC residual currents, pulsating DC residual currents and smooth DC residual currents. Tripping values are defined up to 1kHz.
- /// B+ Type: they are sensitive to alternating (sinusoidal) AC residual currents, pulsating DC residual currents and smooth DC residual currents. Tripping values are defined up to 20kHz and they are below 420mA.
- /// Classification regarding break time
- /// Instantaneous: max. break time 40ms (Inst.)
- /// G/KV-Short time delay: time delayed min. 10ms and max. 40ms (G/KV)
- /// S-Selective: time delayed min. 40ms and max. 150ms (S)

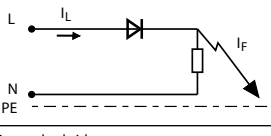
EFI-P2 (2M)		Type AC		Type A	
		Inst.	Inst.	G/KV	S
	For alternating residual current	✓	✓	✓	✓
	For alternating and pulsating direct residual current		✓	✓	✓
	Short-circuit capacity with back-up fuse	✓	✓	✓	✓
	Lower temperature limit of application -25°C	✓	✓	✓	✓
	VDE 0664, part 1 (up to 80 A)		✓		✓
	Short time delayed (10 - 40 ms)			✓	
	Selective (time delayed 40 -150 ms)				✓

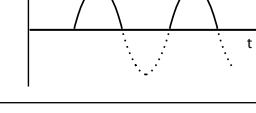
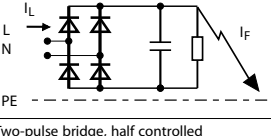
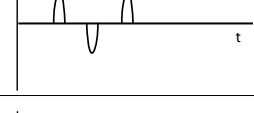
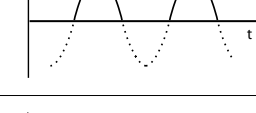
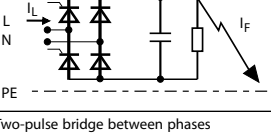
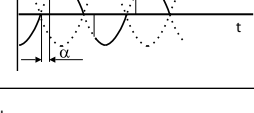
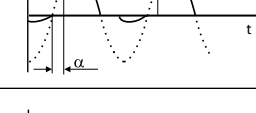
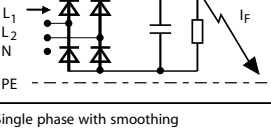
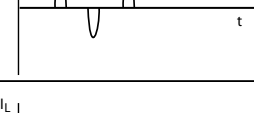
EFI-P4 (4M)		Type AC		Type A		Type B			Type B+		
		Inst.	Inst.	G/KV	S	Inst.	G/KV	S	Inst.	G/KV	S
	For alternating residual current	✓	✓	✓	✓	✓	✓	✓	✓	✓	✓
	For alternating and pulsating direct residual current		✓	✓	✓	✓	✓	✓	✓	✓	✓
  	For alternating, pulsating direct and smooth DC residual current (up to 1kHz)					✓	✓	✓	✓	✓	✓
  	For alternating, pulsating direct and smooth DC residual current (up to 20kHz)								✓	✓	✓
	Short-circuit capacity with back-up fuse	✓	✓	✓	✓	✓	✓	✓	✓	✓	✓
	Lower temperature limit of application -25°C	✓	✓	✓	✓	✓	✓	✓	✓	✓	✓
	VDE 0664, part 1 (up to 80 A)		✓		✓	✓		✓	✓		✓
	Short time delayed (10 - 40 ms)			✓			✓			✓	
	Selective (time delayed 40 -150 ms)				✓			✓			✓

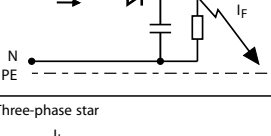
Simple household installations without electronic components	Household installations with electronic components (LCD TV, computers, printers, wash machines, ...)	Surge current proof 3kA (8/20µs). High immunity against unwanted tripping. For S: ensuring selectivity in case of serially connected RCD's	Installations where 3f frequency converters and speed regulated machines are used (elevators, cranes). PV systems on a.c. side, Charging stations for electric vehicles, UPS, computer data centres, X-ray devices	Surge current proof 3kA (8/20µs) High immunity against unwanted tripping. For S: ensuring selectivity in case of serially connected RCD's	Requirement for increased fire protection according to VDE 0664-400
 <p>AC type - Instantaneous 2p / 4p $I_n = 25, 32, 40, 63, 80, 100 \text{ A}$ $I_{\Delta n} = 30, 100, 300, 500 \text{ mA}$</p>					
<p>A type - Instantaneous 2p / 4p $I_n = 25, 40, 63, 80, 100, 125 \text{ A}$ $I_{\Delta n} = 30, 100, 300, 500 \text{ mA}$</p> <p>A type - G/KV (short-time delay: time delayed min. 10ms and max. 40ms) & S (selective: time delayed min. 40ms and max. 150ms) 2p / 4p $I_n = 25, 40, 63, 80, 100, 125 \text{ A}$ $I_{\Delta n} = 100, 300 \text{ mA}$</p>					
<p>B type - Instantaneous (Tripping values are defined up to 1kHz) 4p $I_n = 25, 40, 63 \text{ A}$ $I_{\Delta n} = 30, 300 \text{ mA}$</p>					
<p>B type - G/KV (short-time delay: time delayed min. 10ms and max. 40ms) & S (selective: time delayed min. 40ms and max. 150ms) 4p $I_n = 25, 40, 63, 100, 125 \text{ A}$ $I_{\Delta n} = 100, 300 \text{ mA}$</p>					
<p>B+ type - Instantaneous (Tripping values are defined up to 20kHz and they are below 420mA) according to VDE 0664-400 4p $I_n = 25, 40, 63 \text{ A}$ $I_{\Delta n} = 30, 100, 300 \text{ mA}$</p>					

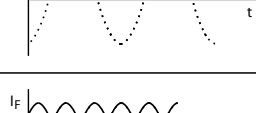
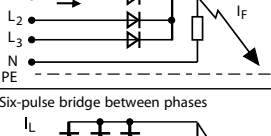
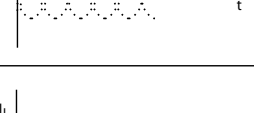
Use of AC, A, and B type of RCCBs in case of different fault conditions

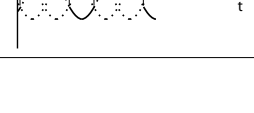
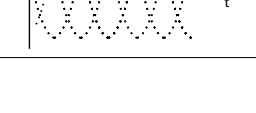
			AC	A	B, B+	
Connection						
		Normal mains current				
1	Single phase 			✓	✓	✓
2	Phase control 			✓	✓	✓
3	Burst control 			✓	✓	✓
4	Single phase rectifier 				✓	✓
5	Two-pulse bridge 				✓	✓
6	Two-pulse bridge, half controlled 				✓	✓
7	Two-pulse bridge between phases 				✓	✓
8	Single phase with smoothing 					✓
9	Three-phase star 					✓
10	Six-pulse bridge between phases 					✓

Residual Current Circuit Breakers EFI-P

- Individual test measurements and other production data for each device can be read from the QR code, as well as instruction manuals and other technical materials



- Fully automated assembly line, enabling more intermediate measurements during assembly process to ensure best functionality of final product



- Patented two-step mechanism for max reliability of operation

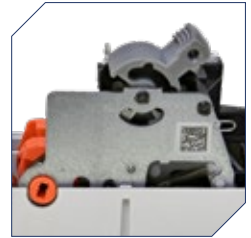

- Improved housing attachment with sealed screws

- Power dissipation per pole reduced by up to 45%
- High mechanical endurance: > 10.000 cycles
- High electrical endurance: > 4.000 cycles
- Rated conditional short-circuit current: 10 kA

- All important components are marked with a data matrix code, containing individual test results and thus ensuring exact traceability and highest quality control



- The terminals accept not only wires but also time saving busbars
- RCCBs can be supplied with single phase and three phase busbars
- Supply is possible both from top and bottom terminals



- Basic installation requirements are engraved into housing



- Real contact position indication for easier identification, whether RCCB is in ON or OFF position
- Clearly marked terminals to ensure appropriate connection



ASTI / Residual Current Circuit Breakers

Reset version: in case of differential current, the button moves to the "trip" (middle) position. In case of manual turn off, the button moves to the "off" (lowest) position.



NL version: Connection of the neutral conductor on the left side, which allows the use of standard busbars (1p, 3p) for connecting RCCBSs and MCBs



127 V version: For use in lower than standard system voltage (for instance 110V, 125V or 127V) systems.



The possibility of installing additional accessories (auxiliary switch, shunt trip release)



All necessary technical & installation information can be found on the front and side of the device

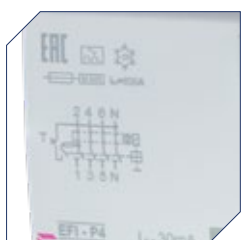

Test button enables user to check residual functionality



Better protection of terminals against touching the parts under voltage

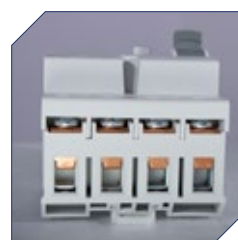

A and AC type residual current circuit breaker EFI-P2(R) & EFI-2

Rated residual current 0,03 - 0,5 A	Rated current 16 - 125 A	Type A, AC
---	------------------------------------	----------------------

Technical data EFI-P2(R) Instantaneous type AC & A

	EFI-P2, EFI-P2R 16-80A	EFI-P2R 100-125A
Electrical		
Rated Voltage U_n	230 / 240 V AC	230 V AC
Rated current I_n	16, 25, 40, 63, 80A	100, 125A
Rated frequency f_n	50/60Hz	50Hz
Rated insulation voltage U_i	440V	400V
Rated impulse withstand voltage (1,2/50 μ s)	4kV	4kV
Peak withstand current (8/20 μ s)	400A	250A
Electrical isolation	> 4mm contact space	
Rated residual operating current $I_{\Delta n}$	0,03; 0,1; 0,3 & 0,5A	
Rated conditional short-circuit current I_{cn}	10kA	10kA
Rated making and breaking capacity I_m	800A	1250A
Max back-up fuse for short circuit protection	80A gG	125A gG
Voltage range test circuit	150-264V	150-264V
Min. operating voltage	voltage independent	voltage independent
Insulating class	B	B
Standards	IEC/EN 61008	IEC/EN 61008
Mechanical Endurance (cycles)	> 10.000	> 5.000
Electrical endurance (cycles)	> 4.000	> 2.000
Shock resistance acc. to	IEC/EN 61008-1	IEC/EN 61008-1
Resistance to vibrations acc. To IEC 60068-2-7	5g (10, 60 & 500Hz)	5g (10, 60 & 500Hz)
Mechanical		
Frame size	45mm	45mm
Device height	68mm (DIN rail acc to EN6071)	
Device width	36mm (2 x Module units)	36mm (2 x Module units)
Degree of protection	IP20	IP20
Upper and lower terminals	open mounted/lift terminals	
Terminal capacity	1-25mm ²	1-50mm ²
Terminal screw	M5 (Pozidrive PZ2)	M6 (Pozidrive PZ2)
Terminal torque	max. 3Nm	max 5,0Nm
Busbar thickness	0,8 - 2 mm	0,8 - 2 mm
Operating temperature	-25°C ... +70°C	-25°C ... +55°C
Storage and transport temperature	-40°C ... +70°C	-40°C ... +70°C
Resistance to climatic conditions	IEC/EN 61008	IEC/EN 61008
Contact position indicator	mechanical red/green	
Mounting position	any	
Mounting on the rail	35mm acc to EN50022	
Supply possibility	top or bottom	

EFI-P2, EFI-P2R 16 - 80A

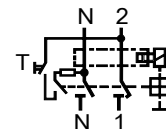
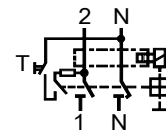
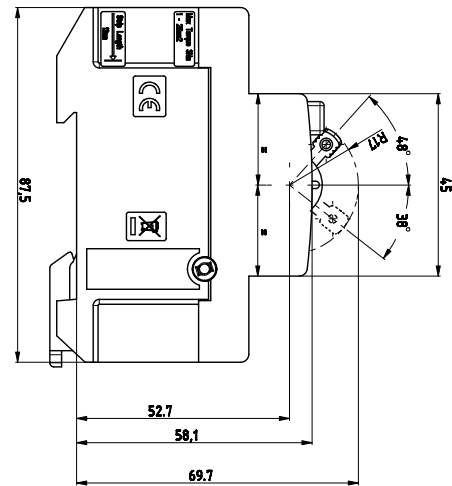
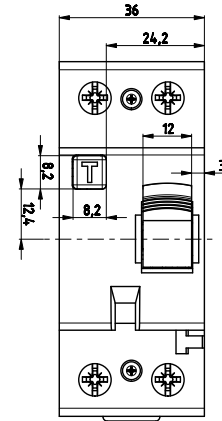

Version with N-pole on the left

I_n [A]	Power dissipation EFI-P2 P/pole [W]
16	0,46-0,51
25	1,22-1,27
40	3,48-3,72
63	2,14-2,58
80	3,53-3,82
100	7,35-7,65
125	10,7-11,3

ASTI / Residual Current Circuit Breakers

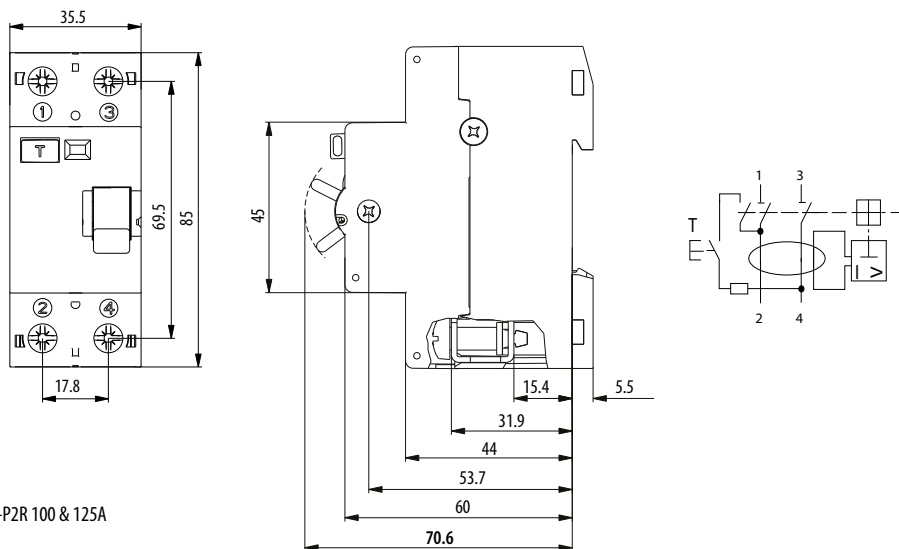

EFI-P2R 100 & 125A

EFI-P2 Instantaneous, EFI-P2R Instantaneous

I_n [A]	$I_{\Delta n}$ [A]	Type A	Type A Code No.	Type A Reset	Type A - R Code No.	Type AC	Type AC Code No.	g	
16		EFI-P2 A 16/0.03	002061110	EFI-P2R A 16/0.03	002061460	EFI-P2 AC 16/0.03	002061210	175	1/54
25		EFI-P2 A 25/0.03	002061111	EFI-P2R A 25/0.03	002061461	EFI-P2 AC 25/0.03	002061211	175	1/54
40		EFI-P2 A 40/0.03	002061112	EFI-P2R A 40/0.03	002061462	EFI-P2 AC 40/0.03	002061212	175	1/54
63	0.03	EFI-P2 A 63/0.03	002061113	EFI-P2R A 63/0.03	002061463	EFI-P2 AC 63/0.03	002061213	190	1/54
80		EFI-P2 A 80/0.03	002061114	EFI-P2R A 80/0.03	002061464	EFI-P2 AC 80/0.03	002061214	190	1/54
100	/	/	/	EFI-P2R A 100/0.03	002061465	/	/	184	1/54
125	/	/	/	EFI-P2R A 125/0.03	002061466	/	/	184	1/54
16		EFI-P2 A 16/0.1	002061120	EFI-P2R A 16/0.1	002061470	EFI-P2 AC 16/0.1	002061220	175	1/54
25		EFI-P2 A 25/0.1	002061121	EFI-P2R A 25/0.1	002061471	EFI-P2 AC 25/0.1	002061221	175	1/54
40		EFI-P2 A 40/0.1	002061122	EFI-P2R A 40/0.1	002061472	EFI-P2 AC 40/0.1	002061222	175	1/54
63	0.1	EFI-P2 A 63/0.1	002061123	EFI-P2R A 63/0.1	002061473	EFI-P2 AC 63/0.1	002061223	190	1/54
80		EFI-P2 A 80/0.1	002061124	EFI-P2R A 80/0.1	002061474	EFI-P2 AC 80/0.1	002061224	190	1/54
100	/	/	/	EFI-P2R A 100/0.1	002061475	/	/	184	1/54
125	/	/	/	EFI-P2R A 125/0.1	002061476	/	/	184	1/54
16		EFI-P2 A 16/0.3	002061130	EFI-P2R A 16/0.3	002061480	EFI-P2 AC 16/0.3	002061230	175	1/54
25		EFI-P2 A 25/0.3	002061131	EFI-P2R A 25/0.3	002061481	EFI-P2 AC 25/0.3	002061231	175	1/54
40		EFI-P2 A 40/0.3	002061132	EFI-P2R A 40/0.3	002061482	EFI-P2 AC 40/0.3	002061232	175	1/54
63	0.3	EFI-P2 A 63/0.3	002061133	EFI-P2R A 63/0.3	002061483	EFI-P2 AC 63/0.3	002061233	190	1/54
80		EFI-P2 A 80/0.3	002061134	EFI-P2R A 80/0.3	002061484	EFI-P2 AC 80/0.3	002061234	190	1/54
100	/	/	/	EFI-P2R A 100/0.3	002061485	/	/	184	1/54
125	/	/	/	EFI-P2R A 125/0.3	002061486	/	/	184	1/54
16		EFI-P2 A 16/0.5	002061140	EFI-P2R A 16/0.5	002061490	EFI-P2 AC 16/0.5	002061240	175	1/54
25		EFI-P2 A 25/0.5	002061141	EFI-P2R A 25/0.5	002061491	EFI-P2 AC 25/0.5	002061241	175	1/54
40		EFI-P2 A 40/0.5	002061142	EFI-P2R A 40/0.5	002061492	EFI-P2 AC 40/0.5	002061242	175	1/54
63	0.5	EFI-P2 A 63/0.5	002061143	EFI-P2R A 63/0.5	002061493	EFI-P2 AC 63/0.5	002061243	190	1/54
80		EFI-P2 A 80/0.5	002061144	EFI-P2R A 80/0.5	002061494	EFI-P2 AC 80/0.5	002061244	190	1/54
100	/	/	/	EFI-P2R A 100/0.5	002061495	/	/	184	1/54
125	/	/	/	EFI-P2R A 125/0.5	002061496	/	/	184	1/54



16 - 80 A



100, 125A

Reset version



In the reset version, the toggle position clearly indicates the reason for tripping, preventing user mistakes and always making it clear whether the system turning off was intentional (manual) or

the result of a fault in the electrical circuit. In case of differential current, the button moves to the “trip” (middle) position. In case of manual turn off, the button moves to the “off” (lowest) position.

EFI-P2 Special versions

I_n [A]	$I_{\Delta n}$ [A]	Type A 127V	127V Code No.	Type A NL	NL Code No.		
16	0.03	EFI-P2 A 16/0.03 127V	002061350	EFI-P2 A 16/0.03 NL	002061410	175	1/54
25		EFI-P2 A 25/0.03 127V	002061351	EFI-P2 A 25/0.03 NL	002061411	175	1/54
40		EFI-P2 A 40/0.03 127V	002061352	EFI-P2 A 40/0.03 NL	002061412	175	1/54
63		EFI-P2 A 63/0.03 127V	002061353	EFI-P2 A 63/0.03 NL	002061413	190	1/54
80		EFI-P2 A 80/0.03 127V	002061354	EFI-P2 A 80/0.03 NL	002061414	190	1/54
16	0.1	EFI-P2 A 16/0.1 127V	002061360	EFI-P2 A 16/0.1 NL	002061420	175	1/54
25		EFI-P2 A 25/0.1 127V	002061361	EFI-P2 A 25/0.1 NL	002061421	175	1/54
40		EFI-P2 A 40/0.1 127V	002061362	EFI-P2 A 40/0.1 NL	002061422	175	1/54
63		EFI-P2 A 63/0.1 127V	002061363	EFI-P2 A 63/0.1 NL	002061423	190	1/54
80		EFI-P2 A 80/0.1 127V	002061364	EFI-P2 A 80/0.1 NL	002061424	190	1/54
16	0.3	EFI-P2 A 16/0.3 127V	002061370	EFI-P2 A 16/0.3 NL	002061430	175	1/54
25		EFI-P2 A 25/0.3 127V	002061371	EFI-P2 A 25/0.3 NL	002061431	175	1/54
40		EFI-P2 A 40/0.3 127V	002061372	EFI-P2 A 40/0.3 NL	002061432	175	1/54
63		EFI-P2 A 63/0.3 127V	002061373	EFI-P2 A 63/0.3 NL	002061433	190	1/54
80		EFI-P2 A 80/0.3 127V	002061374	EFI-P2 A 80/0.3 NL	002061434	190	1/54



NL version

Special versions

127V version: For use in in lower than standard system voltage (for instance 110V, 125V or 127V) system

NL version: Connection of the neutral conductor on the left side, which allows the use of standard busbars (1p, 3p) for connecting RCCBSs and MCBs



Technical data EFI-2 Short time delay & Selective

Type	G/KV type	S type	S Reset
Electrical			
Rated voltage U_n	230/240V AC	230/240V AC	230V AC
Rated current I_n	25, 40, 63A	25, 40, 63A	100, 125A
Rated Insulation voltage U_i	440V	440V	440V
Rated frequency f_n	50/60Hz	50/60Hz	50Hz
Peak withstand current	3kA (8/20 μ s) surge current proof	5kA (8/20 μ s) surge current proof	3kA (8/20 μ s) surge current proof
Electrical isolation	> 4mm contact space	> 4mm contact space	> 4mm contact space
Rated residual operating current $I_{\Delta n}$	0,03; 0,1 & 0,3A	0,1 & 0,3A	0,1 & 0,3A
Rated conditional short-circuit current I_{cn}	10kA	10kA	10kA
Rated making and breaking capacity I_m	630A	630A	1250A
Maximum back-up fuse	80A gG	80A gG	125A gG
Insulating class	B	B	B
Standard	IEC/EN 61008, OVE E 8601	IEC/EN 61008	IEC/EN 61008
Mechanical endurance (op. c.)	> 4000	> 4000	> 5000
Electrical endurance (op. c.)	> 2000	> 2000	> 2000
Mechanical			
Frame size	45mm	45mm	45mm
Device height	68mm (DIN rail acc to EN60715)	68mm (DIN rail acc to EN60715)	70,6mm (DIN rail acc to EN60715)
Device width	36mm (2 x Module units 18mm)	36mm (2 x Module units 18mm)	35,5mm (2 x Module units 17,8mm)
Degree of protection	IP20	IP20	IP20
Upper and lower terminals	open mounted/lift terminals	open mounted/lift terminals	open mounted/lift terminals
Terminal capacity	1-25mm ²	1-25mm ²	1-50mm ²
Terminal screw	M5 (Pozidrive PZ2)	M5 (Pozidrive PZ2)	M6 (Pozidrive PZ2)
Terminal torque	2-2,5Nm	2-2,5Nm	2,5-5Nm
Busbar thickness	0,8 - 2 mm	0,8 - 2 mm	0,8 - 2 mm
Operating temperature	-25°C ... +70°C	-25°C ... +70°C	-25°C ... +40°C
Storage and transport temperature	-40°C ... +70°C	-40°C ... +70°C	-35°C ... +60°C
Resistance to climatic conditions	IEC/EN 61008	IEC/EN 61008	acc. to IEC 60068-2-30: 28 cycles (55 °C, 95% relative humidity)
Resistance to vibrations acc. to IEC 60068-2-7	5g (10,60 & 500Hz)	5g (10,60 & 500Hz)	/
Contact position indicator	mechanical red/green	mechanical red/green	mechanical red/green
Supply possibility	Top or bottom	Top or bottom	Top or bottom
Mounting position	any	any	any

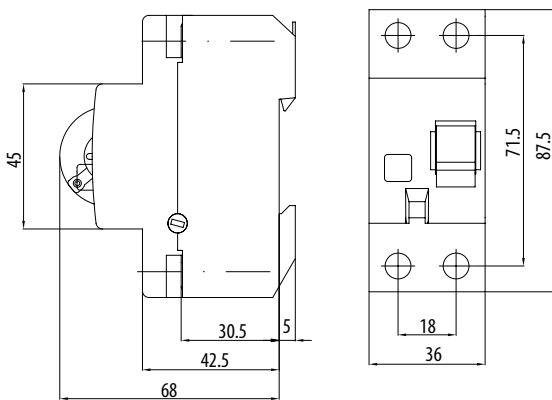

EFI-P2 G/KV & S 25-63A

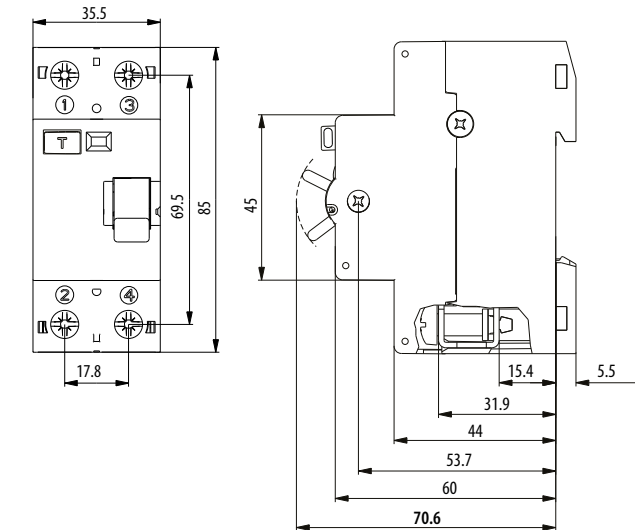

EFI-P2R S 100&125A



EFI-2 Short time delay & Selective

I_n [A]	$I_{\Delta n}$ [A]	Type A G/KV-Short time delay	G/KV Code No.	Type A S-Selective	S Code No.	Type A Selective Reset**	S - R Code No.		
25	0,03	EFI-2 A G/KV 25/0.03	002062727	/	/	/	/	197	1/54
40		EFI-2 A G/KV 40/0.03	002062728	/	/	/	/	197	1/54
63		EFI-2 A G/KV 63/0.03	002062729	/	/	/	/	206	1/54
25	0,1	EFI-2 A G/KV 25/0.1	002063727	EFI-2 A S 25/0.1	002063732	/	/	193	1/54
40		EFI-2 A G/KV 40/0.1	002063728	EFI-2 A S 40/0.1	002063733	/	/	193	1/54
63		EFI-2 A G/KV 63/0.1	002063729	EFI-2 A S 63/0.1	002063734	/	/	196	1/54
100	0,3	/	/	/	/	EFI-P2R A S 100/0.1	002061184	184	1/54
125		/	/	/	/	EFI-P2R A S 125/0.1	002061185	184	1/54
25		/	/	EFI-2 A S 25/0.3	002064732	/	/	198	1/54
40	0,3	/	/	EFI-2 A S 40/0.3	002064733	/	/	198	1/54
63		/	/	EFI-2 A S 63/0.3	002064734	/	/	204	1/54
100		/	/	/	/	EFI-P2R A S 100/0.3	002061194	184	1/54
125	/	/	/	/	/	EFI-P2R A S 125/0.3	002061195	184	1/54

** Reset version: in case of differential current, the button moves to the "trip" (middle) position. In case of manual turn off, the button moves to the "off" (lowest) position.



G/KV



S

I_n [A]	Power dissipation EFI-2 G/KV & S type	
	P / pole (W)	
25	1,29-1,43	
40	2,80 - 3,05	
63	4,28 - 5,34	
100	7,35-7,65	
125	10,7-11,3	

Conductor cross-section [mm ²]	Number of single conductors, rigid, single-wire CU conductor				
	1	2	3	4	5
1,5	✓	✓	✓	✓	✗
2,5	✓	✓	✓	✗	✗
4	✓	✓	✓	✗	✗
6	✓	✓	✗	✗	✗
10	✓	✓	✗	✗	✗
16	✓	✗	✗	✗	✗
25	✓	✗	✗	✗	✗

Remark: When you use more than 2 cables you have to be careful how those cables are inserted to ensure proper pressure on each cable

Conductor cross-section [mm ²]	Number of single conductors, flexible Cu conductors with cable ferrule					
	1	2	3	4	5	6
1,5	✓	✓	✓	✓	✓	✓
2,5	✓	✓	✓	✓	✓	✓
4	✓	✓	✓	✓	✓	✓
6	✓	✓	✓	✗	✗	✗
10	✓	✓	✗	✗	✗	✗
16	✓	✗	✗	✗	✗	✗
25	✓	✗	✗	✗	✗	✗

Combination of rigid single-wire and flexible multi-wire Cu conductors is not allowed

A and AC type residual current circuit breaker EFI-P4(R) & EFI-4

Rated residual current 0,03 - 0,5 A	Rated current 16 - 100 A	Type A, AC
---	------------------------------------	----------------------

Technical data EFI-P4(R), EFI-4 Instantaneous type AC & A

	EFI-P4, EFI-P4R 16-63A	EFI-4 80A, EFI-P4 R 100A, 125A
Electrical		
Rated Voltage U_n	400/415V AC	400V AC
Rated current I_n	16, 25, 40, 63A	80, 100, 125A
Rated frequency f_n	50/60Hz	50Hz
Rated insulation voltage U_i	440V	440V
Rated impulse withstand voltage (1,2/50 μ s)	4kV	4kV
Peak withstand current (8/20 μ s)	400A	
Electrical isolation	> 4mm contact space	
Rated residual operating current $I_{\Delta n}$	0,03; 0,1; 0,3 & 0,5A	
Rated conditional short-circuit current I_{cn}	10kA	10kA
Rated making and breaking capacity I_m	630A	800A ($I_n=80A$); 1250A ($I_n=100, 125A$)
Max back-up fuse for short circuit protection	63A gG	80A ($I_n=80A$); 125A ($I_n=100, 125A$)
Voltage range test circuit	150-264V	150-264V
Min. operating voltage	voltage independent	voltage independent
Insulating class	B	B
Standards	IEC/EN 61008	IEC/EN 61008
Mechanical Endurance (cycles)	> 10.000	> 4.000
Electrical endurance (cycles)	> 4.000	> 2.000
Shock resistance acc. to	IEC/EN 61008-1	IEC/EN 61008-1
Resistance to vibrations acc. To IEC 60068-2-7	5g (10, 60 & 500Hz)	5g (10, 60 & 500Hz)
Mechanical		
Frame size	45mm	45mm
Device height	68mm (DIN rail acc to EN6071)	
Device width	72mm (4 x Module Units)	72mm (4 x Module Units)
Degree of protection	IP20	IP20
Upper and lower terminals	open mounted/lift terminals	
Terminal capacity	1-25mm ²	1-25mm ² ($I_n=80A$), 1-50mm ² ($I_n=100, 125A$)
Terminal screw	M5 (Pozidrive PZ2)	M5 (80A) , M6 (100-125A) (Pozidrive PZ2)
Terminal torque	max. 3Nm	max 2,5Nm (80A); max 5,0Nm (100&125A)
Busbar thickness	0,8 - 2 mm	0,8 - 2 mm
Operating temperature	-25°C ... +70°C	-25°C ... +55°C
Storage and transport temperature	-40°C ... +70°C	-35°C ... +60°C
Resistance to climatic conditions	IEC/EN 61008	acc. to IEC 60068-2-30: 28 cycles (55 °C, 95 % relative humidity)
Contact position indicator	mechanical red/green	
Mounting position	any	
Mounting on the rail	35mm acc to EN50022	
Supply possibility	top or bottom	

EFI-P4, EFI-P4R 16 - 63A

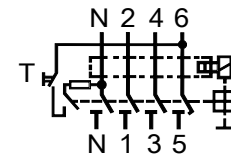
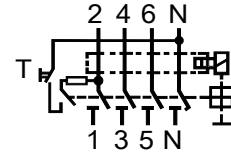

Version with N-pole on the left

EFI-4 80A

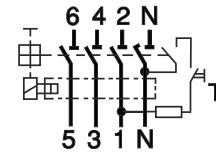

EFI-P4R 100 A, 125A

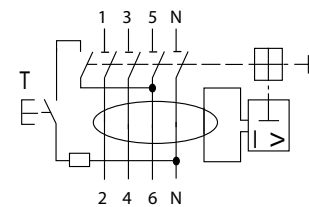

I_n [A]	Power dissipation EFI-P4
	P/pole [W]
16	0,48-0,62
25	1,27-1,52
40	4,14-5,00
63	2,45-3,00
80	8,00-8,90
100	7,35-7,65
125	10,7-11,3

EFI-P4 Instantaneous, EFI-P4R Instantaneous

I_n [A]	$I_{\Delta n}$ [A]	Type A	Type A Code No.	Type A Reset	Type A - R Code No.	Type AC	Type AC Code No.	g	Box	
16	0,03	EFI-P4 A 16/0.03	002061510	EFI-P4R A 16/0.03	002061860	EFI-P4 AC 16/0.03	002061610	300	1/27	
25		EFI-P4 A 25/0.03	002061511	EFI-P4R A 25/0.03	002061861	EFI-P4 AC 25/0.03	002061611	300	1/27	
40		EFI-P4 A 40/0.03	002061512	EFI-P4R A 40/0.03	002061862	EFI-P4 AC 40/0.03	002061612	300	1/27	
63		EFI-P4 A 63/0.03	002061513	EFI-P4R A 63/0.03	002061863	EFI-P4 AC 63/0.03	002061613	330	1/27	
80		EFI-4 A 80/0.03	002062545*	/	/	/	EFI-4 AC 80/0.03	002062145*	380	1/27
100		/	/	/	EFI-P4R A 100/0.03	002061865	/	/	350	1/27
125	/	/	/	EFI-P4R A 125/0.03	002061866	/	/	350	1/27	
16	0,1	EFI-P4 A 16/0.1	002061520	EFI-P4R A 16/0.1	002061870	EFI-P4 AC 16/0.1	002061620	300	1/27	
25		EFI-P4 A 25/0.1	002061521	EFI-P4R A 25/0.1	002061871	EFI-P4 AC 25/0.1	002061621	300	1/27	
40		EFI-P4 A 40/0.1	002061522	EFI-P4R A 40/0.1	002061872	EFI-P4 AC 40/0.1	002061622	300	1/27	
63		EFI-P4 A 63/0.1	002061523	EFI-P4R A 63/0.1	002061873	EFI-P4 AC 63/0.1	002061623	330	1/27	
80		EFI-4 A 80/0.1	002063545*	/	/	/	EFI-4 AC 80/0.1	002063145*	380	1/27
100		/	/	/	EFI-P4R A 100/0.1	002061875	/	/	350	1/27
125	/	/	/	EFI-P4R A 125/0.1	002061876	/	/	350	1/27	
16	0,3	EFI-P4 A 16/0.3	002061530	EFI-P4R A 16/0.3	002061880	EFI-P4 AC 16/0.3	002061630	300	1/27	
25		EFI-P4 A 25/0.3	002061531	EFI-P4R A 25/0.3	002061881	EFI-P4 AC 25/0.3	002061631	300	1/27	
40		EFI-P4 A 40/0.3	002061532	EFI-P4R A 40/0.3	002061882	EFI-P4 AC 40/0.3	002061632	300	1/27	
63		EFI-P4 A 63/0.3	002061533	EFI-P4R A 63/0.3	002061883	EFI-P4 AC 63/0.3	002061633	330	1/27	
80		EFI-4 A 80/0.3	002064545*	/	/	/	EFI-4 AC 80/0.3	002064145*	380	1/27
100		/	/	/	EFI-P4R A 100/0.3	002061885	/	/	350	1/27
125	/	/	/	EFI-P4R A 125/0.3	002061886	/	/	350	1/27	
16	0,5	EFI-P4 A 16/0.5	002061540	EFI-P4R A 16/0.5	002061890	EFI-P4 AC 16/0.5	002061640	300	1/27	
25		EFI-P4 A 25/0.5	002061541	EFI-P4R A 25/0.5	002061891	EFI-P4 AC 25/0.5	002061641	300	1/27	
40		EFI-P4 A 40/0.5	002061542	EFI-P4R A 40/0.5	002061892	EFI-P4 AC 40/0.5	002061642	300	1/27	
63		EFI-P4 A 63/0.5	002061543	EFI-P4R A 63/0.5	002061893	EFI-P4 AC 63/0.5	002061643	330	1/27	
80		EFI-4 A 80/0.5	002065545*	/	/	/	EFI-4 AC 80/0.5	002065145*	380	1/27
100		/	/	/	EFI-P4R A 100/0.5	002061895	/	/	350	1/27
125	/	/	/	EFI-P4R A 125/0.5	002061896	/	/	350	1/27	

* Old version (EFI-4)



16 - 63 A



100, 125A

Reset version



In the reset version, the toggle position clearly indicates the reason for tripping, preventing user mistakes and always making it clear whether the system turning off was intentional (manual) or

the result of a fault in the electrical circuit. In case of differential current, the button moves to the "trip" (middle) position. In case of manual turn off, the button moves to the "off" (lowest) position.

EFI-P4, EFI-P4R

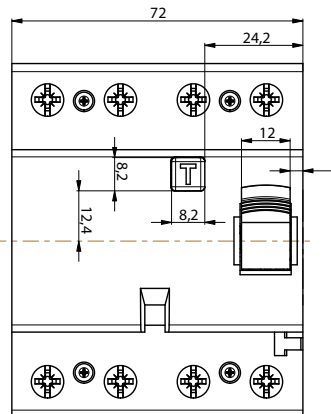
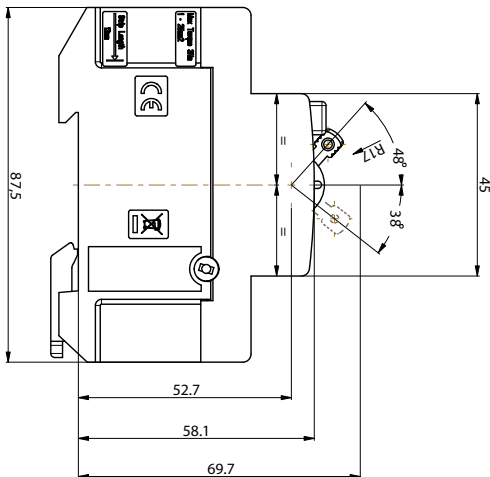

EFI-P4 R 100&125A

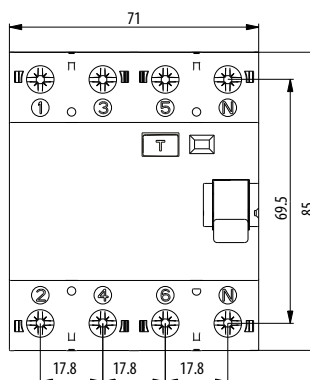
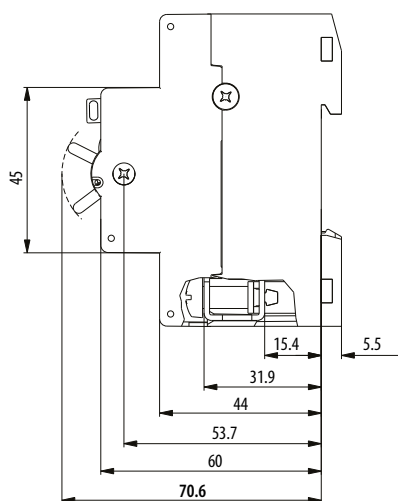

EFI-P4 Special versions

I_n [A]	$I_{\Delta n}$ [A]	Type A 127V	127V Code No.	Type A NL	NL Code No.	g	Box
16	0,03	EFI-P4 A 16/0.03 127V	002061750	EFI-P4 A 16/0.03 NL	002061810	300	1/27
25		EFI-P4 A 25/0.03 127V	002061751	EFI-P4 A 25/0.03 NL	002061811	300	1/27
40		EFI-P4 A 40/0.03 127V	002061752	EFI-P4 A 40/0.03 NL	002061812	300	1/27
63	0,1	EFI-P4 A 63/0.03 127V	002061753	EFI-P4 A 63/0.03 NL	002061813	330	1/27
16		EFI-P4 A 16/0.1 127V	002061760	EFI-P4 A 16/0.1 NL	002061820	300	1/27
25		EFI-P4 A 25/0.1 127V	002061761	EFI-P4 A 25/0.1 NL	002061821	300	1/27
40	0,3	EFI-P4 A 40/0.1 127V	002061762	EFI-P4 A 40/0.1 NL	002061822	300	1/27
63		EFI-P4 A 63/0.1 127V	002061763	EFI-P4 A 63/0.1 NL	002061823	330	1/27
16		EFI-P4 A 16/0.3 127V	002061770	EFI-P4 A 16/0.3 NL	002061830	300	1/27
25	0,3	EFI-P4 A 25/0.3 127V	002061771	EFI-P4 A 25/0.3 NL	002061831	300	1/27
40		EFI-P4 A 40/0.3 127V	002061772	EFI-P4 A 40/0.3 NL	002061832	300	1/27
63		EFI-P4 A 63/0.3 127V	002061773	EFI-P4 A 63/0.3 NL	002061833	330	1/27

Special versions

127V version: For use in in lower than standard system voltage (for instance 110V, 125V or 127V) system

NL version: Connection of the neutral conductor on the left side, which allows the use of standard busbars (1p, 3p) for connecting RCCBs and MCBs



Technical data EFI-4 Short time delay & Selective

Type	G/KV type	S type	S Reset
Electrical			
Rated voltage Un	400/415V AC	400/415V AC	400V AC
Rated current In	25, 40, 63A	25, 40, 63A	100 & 125A
Rated Insulation voltage Ui	440V	440V	440V
Rated frequency fn	50/60Hz	50/60Hz	50Hz
Peak withstand current	3kA (8/20µs) surge current proof	5kA (8/20µs) surge current proof	3kA (8/20µs) surge current proof
Electrical isolation	> 4mm contact space	> 4mm contact space	> 4mm contact space
Rated residual operating current IΔn	0,03; 0,1 & 0,3A	0,1 & 0,3A	0,1 & 0,3A
Rated conditional short-circuit current Icn	10kA	10kA	10kA
Rated making and breaking capacity Im	630A	630A	1250A
Maximum back-up fuse	80A gG	80A gG	125A gG
Insulating class	B	B	B
Standard	IEC/EN 61008, OVE E 8601	IEC/EN 61008	IEC/EN 61008
Mechanical endurance (op. c.)	> 4000	> 4000	> 5000
Electrical endurance (op. c.)	> 2000	> 2000	> 2000
Mechanical			
Frame size	45mm	45mm	45mm
Device height	68mm (DIN rail acc to EN60715)	68mm (DIN rail acc to EN60715)	70,6mm (DIN rail acc to EN60715)
Device width	72mm (4 x Module units 18mm)	72mm (4 x Module units 18mm)	71mm (4 x Module units 17,8mm)
Degree of protection	IP20	IP20	IP20
Upper and lower terminals	open mounted/lift terminals	open mounted/lift terminals	open mounted/lift terminals
Terminal capacity	1-25mm ²	1-25mm ²	1-50mm ²
Terminal screw	M5 (Pozidrive PZ2)	M5 (Pozidrive PZ2)	M6 (Pozidrive PZ2)
Terminal torque	2-2,5Nm	2-2,5Nm	2,5-5Nm
Busbar thickness	0,8 - 2 mm	0,8 - 2 mm	0,8 - 2 mm
Operating temperature	-25°C ... +70°C	-25°C ... +70°C	-25°C ... +40°C
Storage and transport temperature	-40°C ... +70°C	-40°C ... +70°C	-35°C ... +60°C
Resistance to vibrations acc. to IEC 60068-2-7	5g (10,60 & 500Hz)	5g (10,60 & 500Hz)	/
Resistance to climatic conditions	IEC/EN 61008	IEC/EN 61008	acc. to IEC 60068-2-30: 28 cycles (55 °C, 95 % relative humidity)
Contact position indicator	mechanical red/green	mechanical red/green	mechanical red/green
Supply possibility	Top or bottom	Top or bottom	Top or bottom
Mounting position	any	any	any

I _n [A]	Power dissipation EFI-4 G/KV & S type	
	P / pole (W)	
25	1,40-1,61	
40	2,73 - 4,11	
63	4,76 - 5,69	
100	7,35-7,65	
125	10,7-11,3	

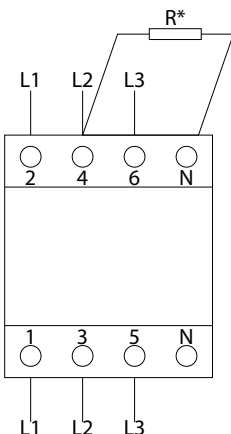



RCD EFI-4 Type in 3-phase system without neutral conductor:

- 30mA: R=2k7/1W/500V
- 100mA: R=1k2/1W/500V
- 300mA: R=470Ω/2W/500V
- 500mA: R=270Ω/3W/500V

* Resistor (R) has to be connected between N and 2 or L3 as to ensure proper functionality of the test button.

EFI-4 Short time delay & Selective

I_n [A]	$I_{\Delta n}$ [A]	Type A G/KV-Short time delay	G/KV Code No.	Type A S-Selective	S Code No.	Type A Selective Reset**	S - R Code No.		
25	0,03	EFI-4 A G/KV 25/0.03	002062747	/	/	/	/	328	1/27
40		EFI-4 A G/KV 40/0.03	002062748	/	/	/	/	328	1/27
63		EFI-4 A G/KV 63/0.03	002062749	/	/	/	/	350	1/27
25	0,1	EFI-4 A G/KV 25/0.1	002063747	EFI-4 A S 25/0.1	002063752	/	/	320	1/27
40		EFI-4 A G/KV 40/0.1	002063748	EFI-4 A S 40/0.1	002063753	/	/	320	1/27
63		EFI-4 A G/KV 63/0.1	002063749	EFI-4 A S 63/0.1	002063754	/	/	338	1/27
100	0,3	/	/	/	/	EFI-P4R A S 100/0.1	002061584	350	1/27
125		/	/	/	/	EFI-P4R A S 125/0.1	002061585	350	1/27
25		EFI-4 A G/KV 25/0.3	002064747	EFI-4 A S 25/0.3	002064752	/	/	320	1/27
40	EFI-4 A G/KV 40/0.3	002064748	EFI-4 A S 40/0.3	002064753	/	/	320	1/27	
63	EFI-4 A G/KV 63/0.3	002064749	EFI-4 A S 63/0.3	002064754	/	/	338	1/27	
100	0,3	/	/	/	/	EFI-P4R A S 100/0.3	002061594	350	1/27
125		/	/	/	/	EFI-P4R A S 125/0.3	002061595	350	1/27

** Reset version: in case of differential current, the button moves to the "trip" (middle) position. In case of manual turn off, the button moves to the "off" (lowest) position.



G/KV



S

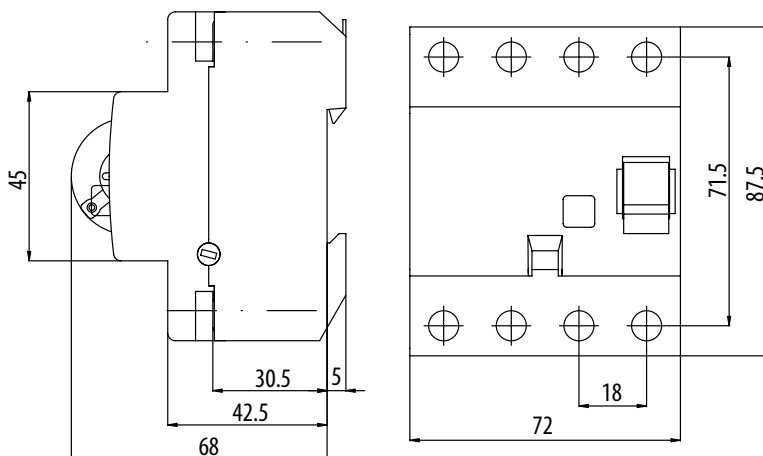

Conductor cross-section [mm ²]	Number of single conductors, rigid, single-wire CU conductor				
	1	2	3	4	5
1,5	✓	✓	✓	✓	✗
2,5	✓	✓	✓	✗	✗
4	✓	✓	✓	✗	✗
6	✓	✓	✗	✗	✗
10	✓	✓	✗	✗	✗
16	✓	✗	✗	✗	✗
25	✓	✗	✗	✗	✗

Remark: When you use more than 2 cables you have to be careful how those cables are inserted to ensure proper pressure on each cable

Conductor cross-section [mm ²]	Number of single conductors, flexible Cu conductors with cable ferrule					
	1	2	3	4	5	6
1,5	✓	✓	✓	✓	✓	✓
2,5	✓	✓	✓	✓	✓	✓
4	✓	✓	✓	✓	✓	✓
6	✓	✓	✓	✗	✗	✗
10	✓	✓	✗	✗	✗	✗
16	✓	✗	✗	✗	✗	✗
25	✓	✗	✗	✗	✗	✗

Combination of rigid single-wire and flexible multi-wire Cu conductors is not allowed

UNIVERSAL CURRENT SENSITIVE RCCBs B and B+ type

APPLICATION

Fault protection (protection against indirect contact of live parts)
 Additional protection (protection in case of direct contact of live parts, $I_{\Delta n} \leq 30\text{mA}$)
 Fire Protection (for locations exposed to fire hazard)

Residual current sensitivity – UNIVERSAL

AC pure sinus residual current, 50/60Hz
 A sinus and pulsating direct current, 50/60Hz
B AC + A + smooth direct current + high frequency (1kHz)
B+ AC + A + smooth direct current + high frequency (20kHz)

Basic types

according to rated values:

4p B $I_n = 25\text{A}, 40\text{A}, 63\text{A}, I_{\Delta n} = 30\text{mA}, 300\text{mA}$
 4p B+ $I_n = 25\text{A}, 40\text{A}, 63\text{A}, I_{\Delta n} = 30\text{mA}, 100\text{mA}, 300\text{mA}$

according to breaking times:

4p B, B+ instantaneous, short time delayed (G/KV), selective (S)

according to the number of poles:

4p, 2p

Standards

IEC/EN 61008-1 basic standard for RCCB's AC and A type
 IEC/EN 62423 additional requirements for type B
 VDE 0664-400 B+ VDE standard for B+ requirements (20kHz)

Mode of operation

Pure a.c. and pulsating d.c. type residual current sensitivity, A voltage independent
 Smooth d.c. current sensitivity: B, B+ voltage dependent
 Minimum operating voltage: 50V

Typical applications

Which are vulnerable to smooth d.c. residual currents:
 Frequency converters,
 Photovoltaic systems, a.c side,
 Charging stations for electric vehicles,
 Variable speed machine tools,
 UPS, computer data centres
 Elevator controls,
 Cranes of all kinds
 Electronic equipment on construction sites,
 Test set-ups in laboratories,
 Installation in general where we can expect d.c. smooth direct residual currents, etc.

RCD ETI Type B in 1-phase system $U_n = 240\text{V}$

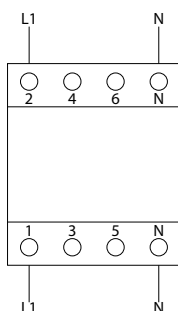

RCD ETI Type B in 3-phase system $U_n = 240/415\text{V}$

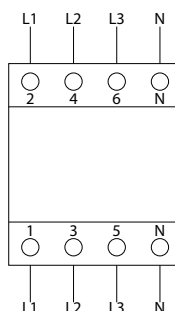

RCD ETI Type B in 3-phase system without neutral conductor - $U_n = 240\text{V}$

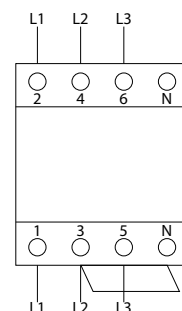

Technical data

Type		B & B+
Electrical		
Design according to	IEC/EN 61008, IEC/EN 62423 B+ -> VDE 0664-400	
Current test marks as printed onto the device		
Rated voltage U_n	240/415 V AC	
Rated frequency f_n	50/60Hz	
Mode of operation	A type functionality: voltage independent B and B+ type functionality: voltage dependent	
Operation voltage electronic	50 – 253V AC	
Voltage range test circuit	196 – 253V AC	
Rated residual operating current $I_{\Delta n}$	Instantaneous	30, 100, 300 mA
	K - short time delayed	30, 100, 300 mA
	S - selective	100, 300 mA
Sensitivity	Alternating, pulsed and smooth direct currents	
Rated insulation voltage U_i	440 V	
Rated impulse withstand voltage U_{imp}	4 kV (1.2/50µs)	
Rated conditional short-circuit current I_{cn}	10 kA	
Rated making and breaking capacity I_m	800 A	
Peak withstand current	3 kA (8/20 µs) surge current proof	
Electrical isolation	> 4 mm contact space	
Maximum back-up fuse $I_n = 25-63A$	Short circuit and overload protection 100 A gG/gL	
Endurance (operating cycles)	electrical	≥ 4000
	mechanical	≥ 10000
Mechanical		
Frame size	45 mm	
Device height	68 mm (DIN rail acc to EN60715)	
Device width	72 mm (4xModule Units 18mm)	
Degree of protection	IP20	
Upper and lower terminals	open mounted/lift terminals	
Terminal protection finger and hand touch safe	IEC/EN 61008	
Terminal capacity	1 - 25 mm ²	
Terminal screw	M5 (Pozidrive PZ2)	
Terminal torque	2 - 2.5 Nm	
Busbar thickness	0.8 - 2 mm	
Operating temperature	-25°C ... +70°C	
Storage- and transport temperature	-40°C ... +70°C	
Resistance to vibrations acc. to IEC 60068-2-7	5g (10,60 & 500Hz)	
Resistance to climatic conditions	IEC/EN 61008	
Contact position indicator	mechanical red / green	
Supply possibility	top or bottom	
Mounting position	any	

Conductor cross-section [mm ²]	Number of single conductors, rigid, single-wire CU conductor				
	1	2	3	4	5
1,5	✓	✓	✓	✓	✗
2,5	✓	✓	✓	✗	✗
4	✓	✓	✓	✗	✗
6	✓	✓	✗	✗	✗
10	✓	✓	✗	✗	✗
16	✓	✗	✗	✗	✗
25	✓	✗	✗	✗	✗

Remark: When you use more than 2 cables you have to be careful how those cables are inserted to ensure proper pressure on each cable

Conductor cross-section [mm ²]	Number of single conductors, flexible Cu conductors with cable ferrule					
	1	2	3	4	5	6
1,5	✓	✓	✓	✓	✓	✓
2,5	✓	✓	✓	✓	✓	✓
4	✓	✓	✓	✓	✓	✓
6	✓	✓	✓	✗	✗	✗
10	✓	✓	✗	✗	✗	✗
16	✓	✗	✗	✗	✗	✗
25	✓	✗	✗	✗	✗	✗

Combination of rigid single-wire and flexible multi-wire Cu conductors is not allowed

RCD ETI Type B in 3-phase system without neutral conductor - $U_n=415V$

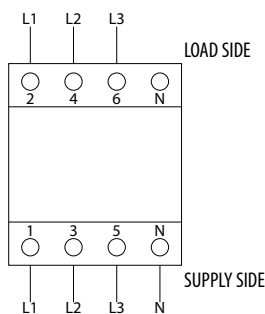

RCD ETI Type B in 3-phase system without neutral conductor - $U_n=415V$

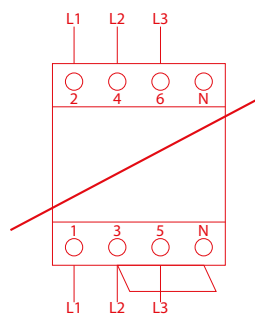

RCD ETI Type B in 3-phase system without neutral conductor - $U_n=415V$

30mA: R=2k7/1W (500V)

300mA: R=470Ω/2W (500V)

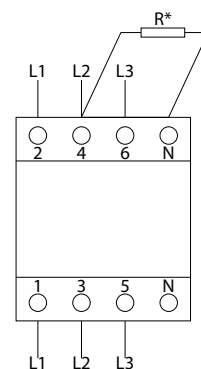

* Resistor (R) has to be connected between N and L2 as to ensure proper functionality of the test button.

B type residual current circuit breaker EFI-P4 B Instantaneous

Rated residual current **0,03 - 0,3 A** Rated current **25 - 63 A** Type **B**

EFI-P4 B Instantaneous

I_n [A]	$I_{\Delta n}$ [A]	Type	Code No.		
25	0,03	EFI-P4 B 40/0.03	002061951	318	1/27
40		EFI-P4 B 25/0.03	002061952	318	1/27
63		EFI-P4 B 63/0.03	002061953	318	1/27
25	0,3	EFI-P4 B 40/0.3	002061971	318	1/27
40		EFI-P4 B 25/0.3	002061972	318	1/27
63		EFI-P4 B 63/0.3	002061973	318	1/27

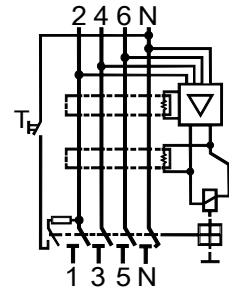
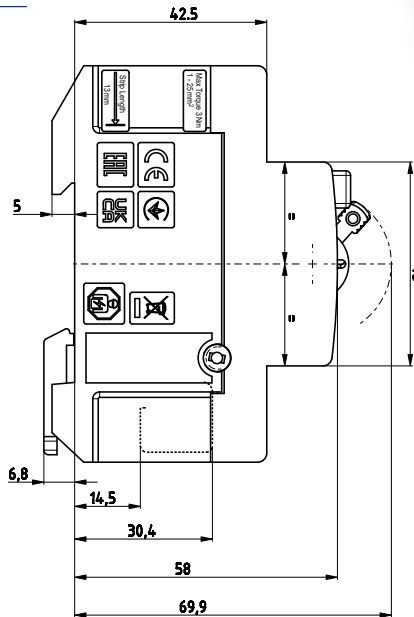
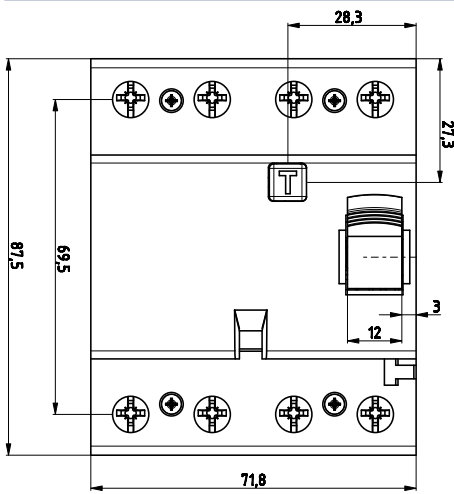

B type residual current circuit breaker EFI-4 B G/KV-Short time delay

Rated residual current **0,03 - 0,3 A** Rated current **25 - 63 A** Type **B (G/KV)**

EFI-4 B G/KV-Short time delay

I_n [A]	$I_{\Delta n}$ [A]	Type B G/KV	B G/KV Code No.	G/KV Reset	B G/KV Reset Code No.		
25	0,03	EFI-4 B G/KV 25/0.03	002062652		/	340	1/27
40		EFI-4 B G/KV 40/0.03	002062653		/	340	1/27
63		EFI-4 B G/KV 63/0.03	002062654		/	345	1/27
100	0,1	/	/	EFI-P4R B G/KV 100/0.03	002061905	350	1/27
125		/	/	EFI-P4R B G/KV 125/0.03	002061906	350	1/27
25		EFI-4 B G/KV 25/0.1	002063652		/	340	1/27
40	0,3	EFI-4 B G/KV 40/0.1	002063653		/	340	1/27
63		EFI-4 B G/KV 63/0.1	002063654		/	345	1/27
100		/	/	/	EFI-P4R B G/KV 100/0.1	002061915	350
125	0,5	/	/	EFI-P4R B G/KV 125/0.1	002061916	350	1/27
25		EFI-4 B G/KV 25/0.3	002064652		/	340	1/27
40		EFI-4 B G/KV 40/0.3	002064653		/	340	1/27
63	0,5	EFI-4 B G/KV 63/0.3	002064654		/	345	1/27
100		/	/	EFI-P4R B G/KV 100/0.3	002061925	350	1/27
125		/	/	EFI-P4R B G/KV 125/0.3	002061926	350	1/27
100	0,5	/	/	EFI-P4R B G/KV 100/0.5	002061935	350	1/27
125		/	/	EFI-P4R B G/KV 125/0.5	002061936	350	1/27





B type residual current circuit breaker EFI-4 B S-Selective

Rated residual current
0,1 - 0,3 A

Rated current
25 - 63 A

Type
B (S)

EFI-4 B S-Selective

I_n [A]	$I_{\Delta n}$ [A]	Type	Code No.		
25	0,1	EFI-4 B S 25/0.1	002063662	340	1/27
40		EFI-4 B S 40/0.1	002063663	340	1/27
63		EFI-4 B S 63/0.1	002063664	345	1/27
25	0,3	EFI-4 B S 25/0.3	002064662	335	1/27
40		EFI-4 B S 40/0.3	002064663	335	1/27
63		EFI-4 B S 63/0.3	002064664	340	1/27



K-Short time delay, S-Selective

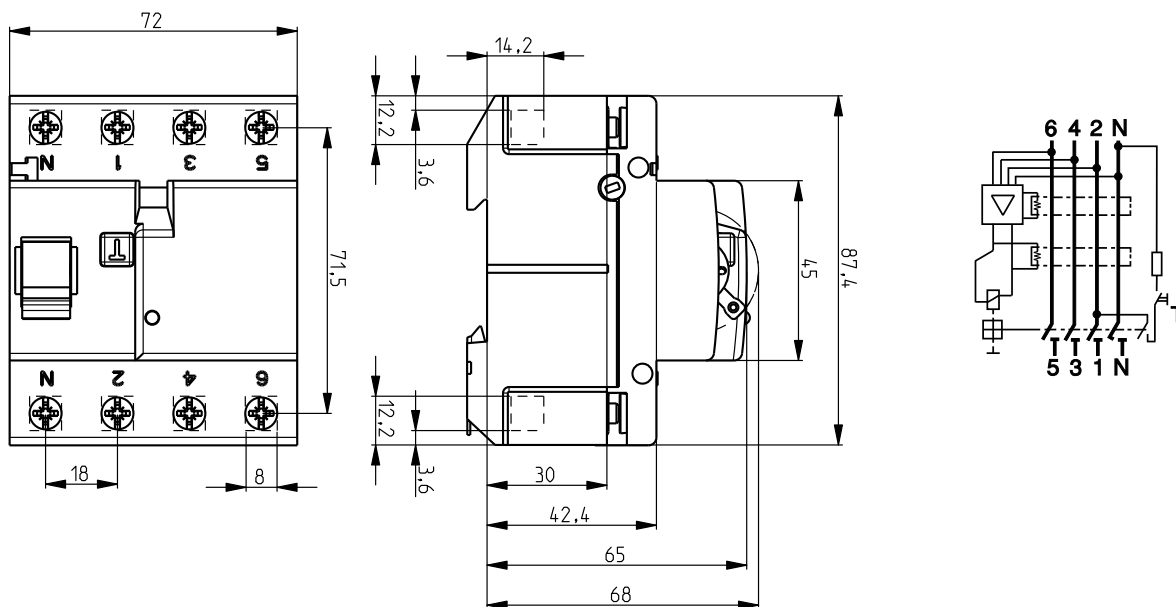

G/KV - Reset (100 & 125A)

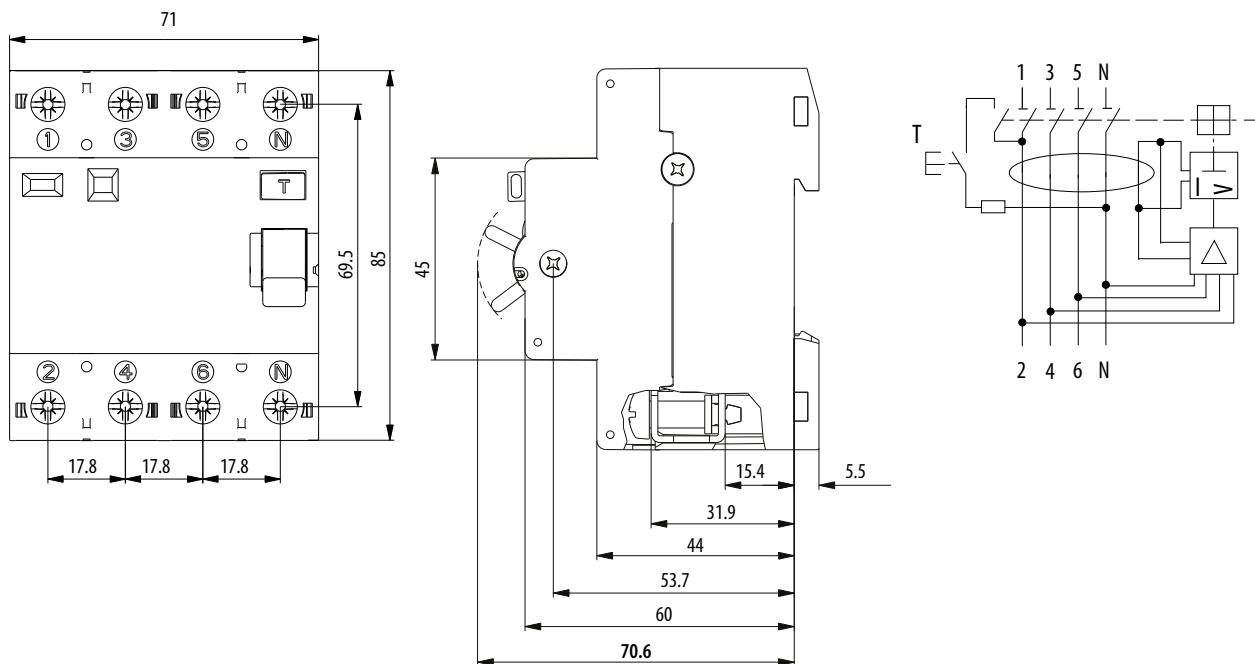

EFI B type

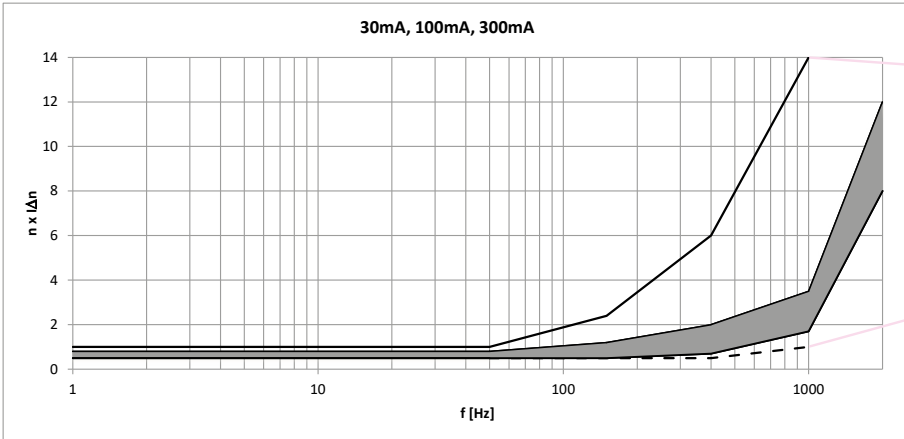

Upper limit according to IEC/EN 62423

Lower limit according to IEC/EN 62423

B+ type residual current circuit breaker EFI-4 B+ Instantaneous

Rated residual current **0,03 - 0,3 A** / Rated current **25 - 63 A** / Type **B+**

EFI-4 B+ Instantaneous

I_n [A]	$I_{\Delta n}$ [A]	Type	Code No.		
25	0,03	EFI-4 B+ 25/0.03	002062647	335	1/27
40		EFI-4 B+ 40/0.03	002062648	335	1/27
63		EFI-4 B+ 63/0.03	002062649	340	1/27
25	0,1	EFI-4 B+ 25/0.1	002063647	335	1/27
40		EFI-4 B+ 40/0.1	002063648	335	1/27
63		EFI-4 B+ 63/0.1	002063649	340	1/27
25	0,3	EFI-4 B+ 25/0.3	002064647	335	1/27
40		EFI-4 B+ 40/0.3	002064648	335	1/27
63		EFI-4 B+ 63/0.3	002064649	340	1/27

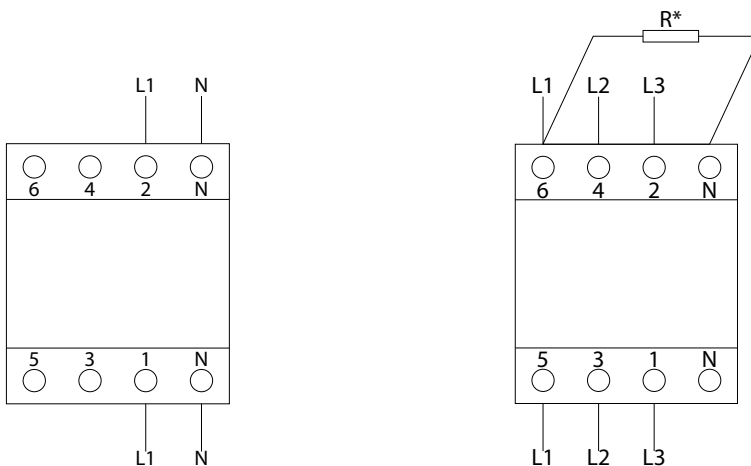

* Resistor (R) has to be connected between N and L1 as to ensure proper functionality of the test button.

RCD ETI Type B+ in 1-phase system $U_n=230V$

RCD ETI Type B+ in 3-phase system without neutral conductor - $U_n=400V$

30mA: $R=2k\Omega/1W$ (500V)

100mA: $R=7k\Omega/1W$ (500V)

300mA: $R=2k\Omega/1W$ (500V)

EFI B+ type

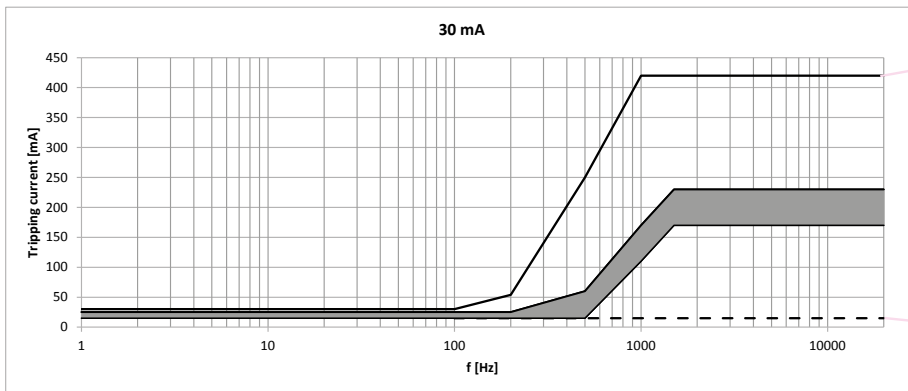

Upper limit according to VDE 0664-400

Lower limit according to VDE 0664-400

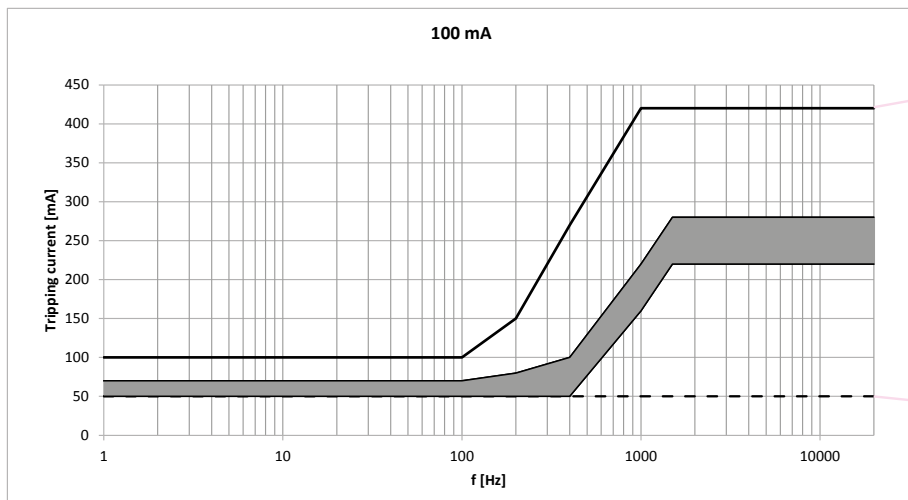

Upper limit according to VDE 0664-400

Lower limit according to VDE 0664-400

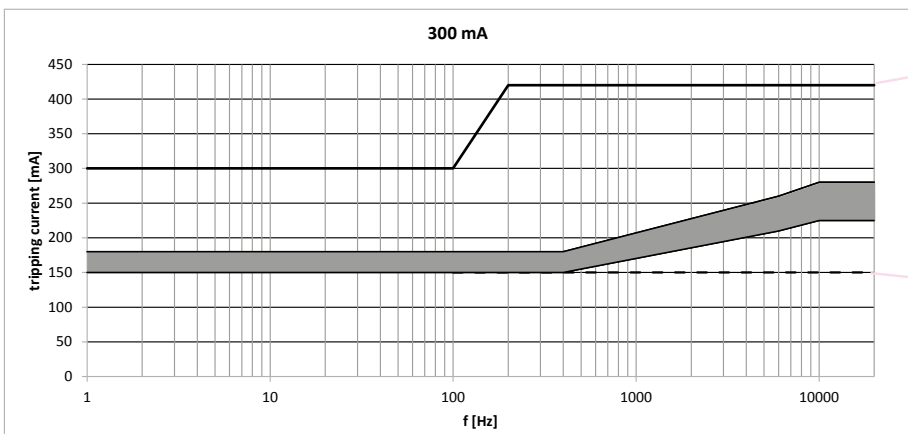

Upper limit according to VDE 0664-400

Lower limit according to VDE 0664-400

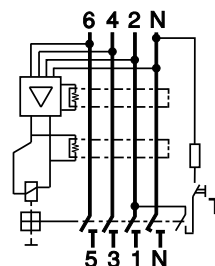
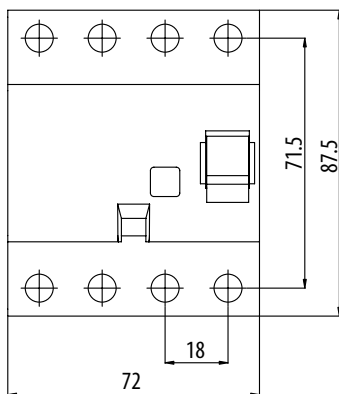
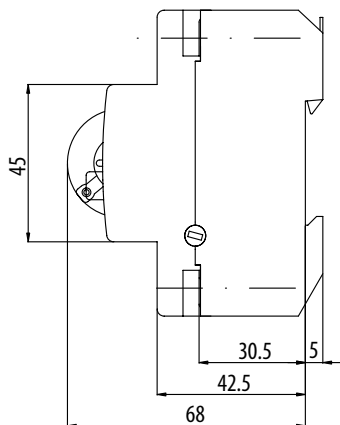

Accessories for residual current circuit breakers EFI



The PS EFI is fixed to EFI series switches. The width of the device is 9 mm, other dimensions are in compliance with EFI switches. The auxiliary switch PS EFI is used for the remote signalling of the state of contact's condition (closed/open) of EFI switches. During fitting, the EFI must be switched off. PS EFI and DA EFI can not be mounted both together, because both can only be mounted on the right side of EFI.

Technical data PS EFI 16-80A

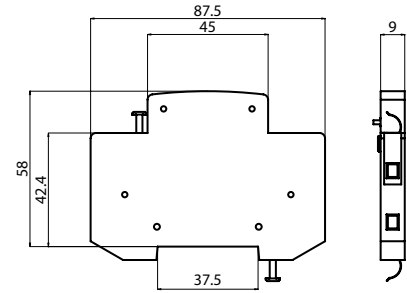
Rated current I_n	6 A (230 V AC), AC 12, 1 A (110 V DC), DC 12
Conditional short-circuit current	1 kA with fuse-link 20 A
Terminals	1-2,5mm ² , max. 0,5Nm
Terminal Screw	M3 (PH1)
Operating temperature	-25°C ... +70°C
Storage and transport temperature	-40°C ... +70°C
Mounting position	any
Standards	EN 62019



Auxiliary Switch PS EFI 16-80A

Type	Contact	Code No.	 g	
PS EFI - MD	NC+NO	002069001	50	1/12
PS EFI - 2M	2xNC	002069002	50	1/12
PS EFI - 2D	2xNO	002069003	50	1/12

NO = make contact
NC = break contact



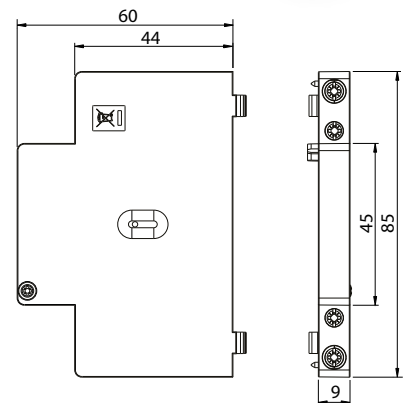

Technical data PS EFI 100-125A

Rated current I_n	6 A (230 V AC), AC 12, 1,5 A (110 V DC), DC 12
Conditional short-circuit current	10 kA with fuse-link 6 A
Terminals	0,75-2,5mm ² , max. 0,8Nm
Terminal Screw	M3 (PZ1)
Operating temperature	-25°C ... +70°C
Storage and transport temperature	-40°C ... +70°C
Mounting position	any
Standards	IEC/EN 60947-1, IEC/EN 60947-5-1, IEC/EN 62019, DIN EN 62019 (VDE 0640)





Auxiliary Switch PS EFI 100-125A

Type	Contact	Code No.	 g	
PS EFI 100/125 - NC+NO	NC+NO	002069006	31	1/12
PS EFI 100/125 - 2xNC	2xNC	002069007	31	1/12
PS EFI 100/125 - 2xNO	2xNO	002069008	31	1/12



NO = make contact
NC = break contact



Sealing piece EFI-2 16-80A

Code No.	 g	
002069011	2	2



**Sealing piece EFI-4 16-80A**

Code No.	 g	
002069012	3	2

**Technical data DA EFI 16-80**

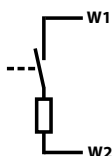
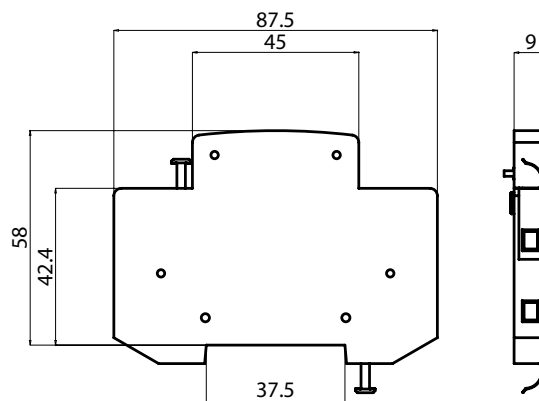
Rated voltage	230V AC
Rated frequency	50/60Hz
Max inrush current	0,8A
Terminals	1-2,5mm ² , max. 0,5Nm
Terminal Screw	M3 (PH1)
Operating temperature	-25°C ... +70°C
Storage and transport temperature	-40°C ... +70°C
Build-in width	9mm
Mounting position	any

**Shunt trip release DA EFI 16-80A**

Type	Code No.	 g	
DA EFI	002069004	45	1/12

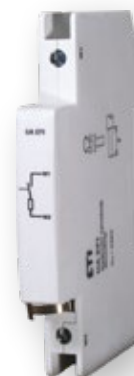

Residual Current Circuit Breakers for Protection of EV Charging Stations EFI-P eV

Rated residual current
0,03 A

Rated current
25 - 63 A

Type
eV

Meets requirements from standard IEC 60364-7-722 --> Low-Voltage electrical Installations - Requirements for special installations or locations - Supplies for electric vehicles

Individual test measurements and other production data for each device can be read from the QR code, as well as instruction manuals and other technical materials



detects smooth DC residual currents above 6 mA
Rated conditional short-circuit current: 10 kA



All necessary technical & installation information can be found on the front and side of the device



Supply is possible both from top and bottom terminals

RCCBs can be supplied with single phase and three phase busbars

Basic installation requirements are engraved into housing



Clearly marked terminals to ensure appropriate connection



Real contact position indication for easier identification, whether RCCB is in ON or OFF position





Better protection of terminals against touching the parts under voltage



Technical data EFI-P4 eV

Type	EFI-P4 eV
Electrical	
Rated Voltage U_n	400/415V AC
Rated current I_n	25, 40, 63 A
Rated frequency f_n	50/60Hz
Mode of operation	A type functionality : voltage independent DC functionality: voltage dependent
Sensitivity	Alternating, pulsed and smooth direct currents
Rated insulation voltage U_i	440V
Rated impulse withstand voltage (1,2/50 μ s)	4kV
Electrical isolation	> 4mm contact space
Rated residual operating current $I_{\Delta n}$	30 mA
DC tripping treshold	6 mA
Rated conditional short-circuit current I_m	10kA
Rated making and breaking capacity I_m	630A
Max back-up fuse for short circuit protection	80A gG
Voltage range test circuit	196 – 253 V AC
Min. operating voltage	80 V
Standards	IEC/EN 61008, IEC 62955:2018
Mechanical Endurance (cycles)	10.000
Electrical endurance (cycles)	2.000
Shock resistance acc. to	IEC/EN 61008-1
Resistance to vibrations acc. To IEC 60068-2-7	5g (10, 60 & 500Hz)
Mechanical	
Frame size	45mm
Device height	68mm (DIN rail acc to EN6071)
Device width	72mm (4 x Module Units)
Degree of protection	IP20
Overvoltage category	III
Upper and lower terminals	open mounted/lift terminals
Terminal capacity	1-25mm ²
Terminal screw	M5 (Pozidrive PZ2)
Terminal torque	max. 3Nm
Busbar thickness	0,8 - 2 mm
Operating temperature	-25°C ... +70°C
Storage and transport temperature	-40°C ... +85°C
Resistance to climatic conditions	IEC/EN 61008
Contact position indicator	mechanical red/green
Mounting position	any
Mounting on the rail	35mm acc to EN50022
Supply possibility	top or bottom
Locking device	Locking is possible through button and cover

EFI-P4 eV

I_n [A]	$I_{\Delta n}$ [A]	Type	Code No.	 g	
25	0,03	EFI-P4 eV 25/0.03	002061991	318	1/27
40		EFI-P4 eV 40/0.03	002061992	318	1/27
63		EFI-P4 eV 63/0.03	002061993	318	1/27

I_n [A]	Maximum power dissipation EFI-4 eV	
	P/pole [W]	
25	1,33	
40	3,12	
63	6,62	

conductor cross-section [mm ²]	Number of single conductors, rigid, single-wire Cu conductor				
	1	2	3	4	5
1,5	✓	✓	✓	✓	✗
2,5	✓	✓	✓	✗	✗
4	✓	✓	✓	✗	✗
6	✓	✓	✗	✗	✗
10	✓	✓	✗	✗	✗
16	✓	✗	✗	✗	✗
25	✓	✗	✗	✗	✗

Remark: When you use more than 2 cables you have to be careful how those cables are inserted to ensure proper pressure on each cable

Conductor cross-section [mm ²]	Number of single conductors, flexible Cu conductors with cable ferrule					
	1	2	3	4	5	6
1,5	✓	✓	✓	✓	✓	✓
2,5	✓	✓	✓	✓	✓	✓
4	✓	✓	✓	✓	✓	✓
6	✓	✓	✓	✗	✗	✗
10	✓	✓	✗	✗	✗	✗
16	✓	✗	✗	✗	✗	✗
25	✓	✗	✗	✗	✗	✗

Combination of rigid single-wire and flexible multi-wire Cu conductors is not allowed



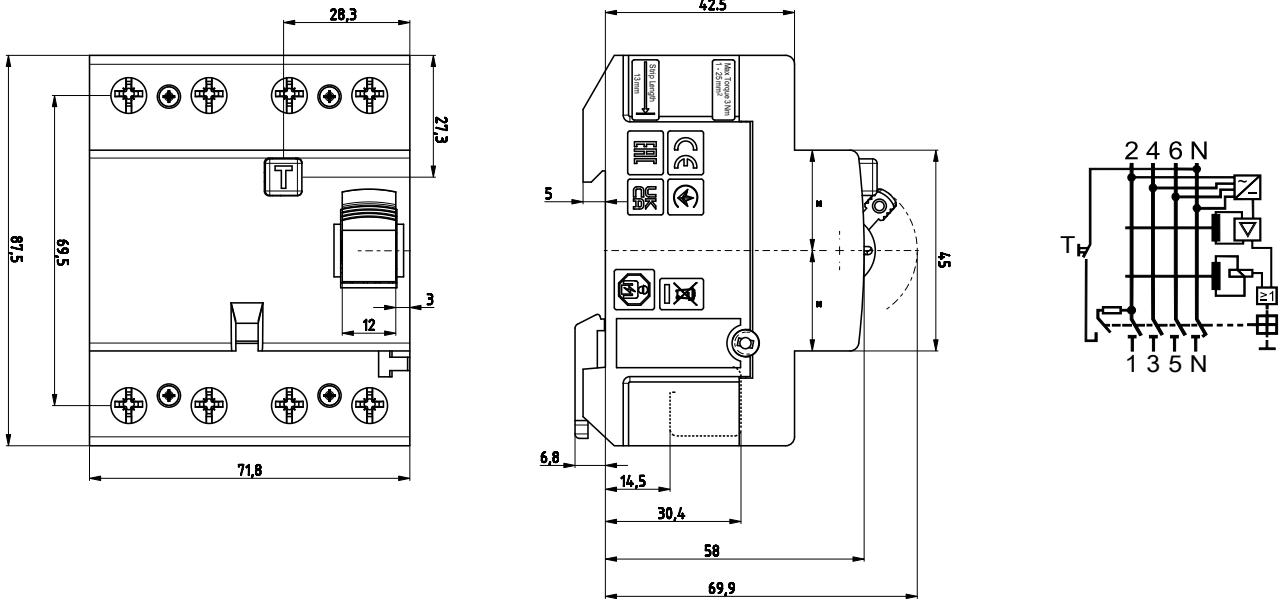

Electrical Design Recommendations

TN-System

TN-System

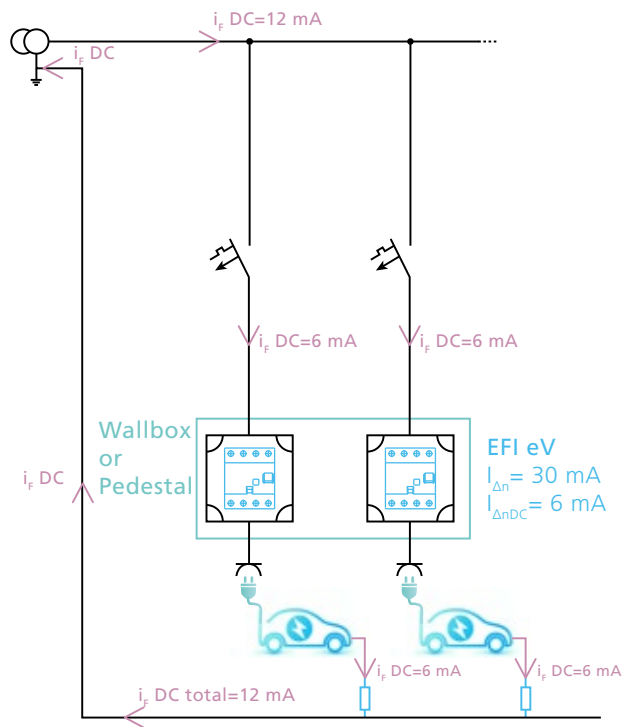
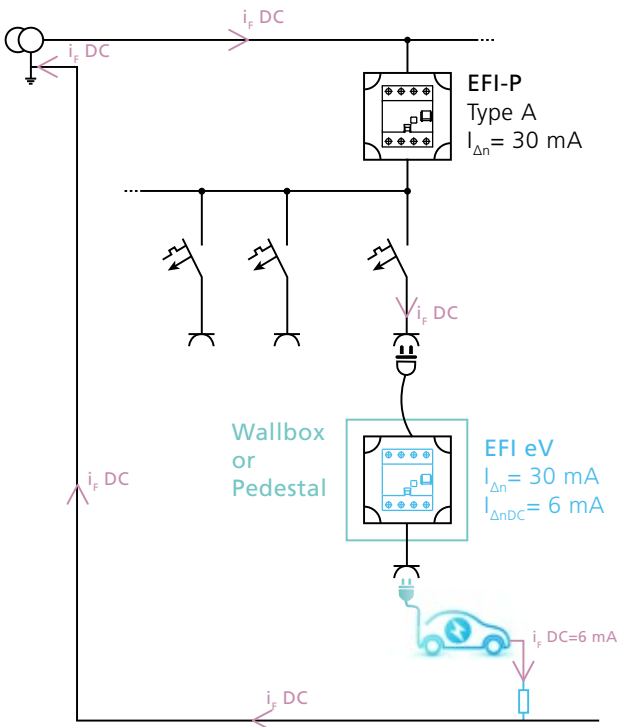

If the charging unit is plugged into an existing socket, protected with a Type A RCCB, additional protection against smooth DC residual currents above 6 mA must be provided (IEC 60364-7-722).

If the charging unit has a fixed connection, EFI eV will provide complete protection against residual currents.

TT-System

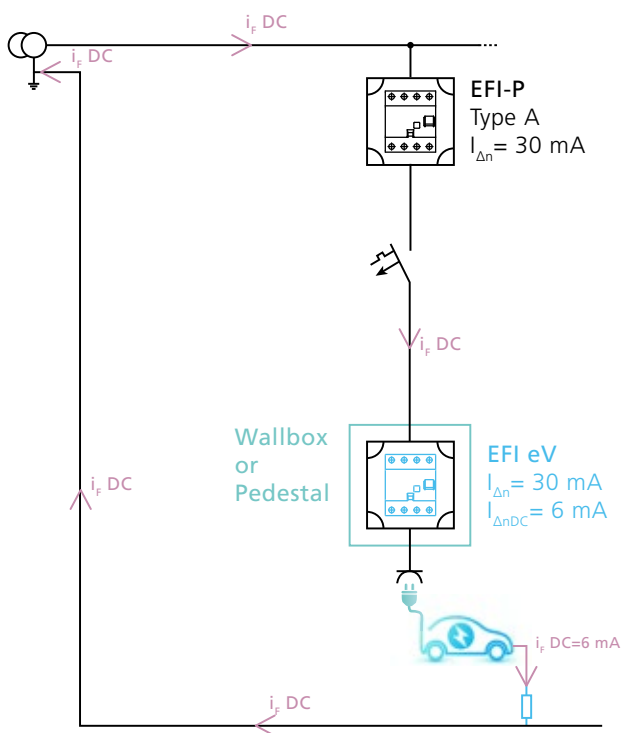

In these systems, switch-off times must comply to stricter rules so even the charging units with fixed connection require a Type A RCCB, which needs to be additionally protected against smooth DC residual currents above 6 mA by EFI eV.

TT-System

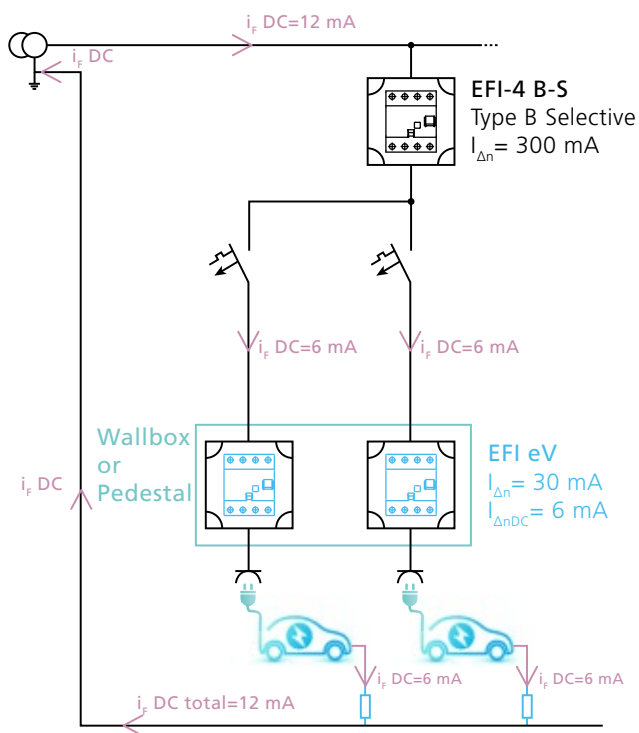

If more charging units are in use, the first RCCB must be a Type B device to protect from the sum of all smooth DC residual currents. Each charging plug socket must also be protected with EFI eV.

ASTI Residual Current Circuit Breakers with Integral Overcurrent Protection - RCBOs

Residual current circuit breaker with integral overcurrent protection KZS - 1M

By combining both the MCB (protection against overcurrent faults) and RCCB (protection against residual currents) functions, the RCBO provides enhanced safety and protection for both people and electrical systems. It is commonly used in residential, commercial and industrial electrical installations with operating temperature down to -35° C.

SPACE SAVING

Two devices (MCB and an RCCB) in a single 1-module unit, switching active and neutral pole.

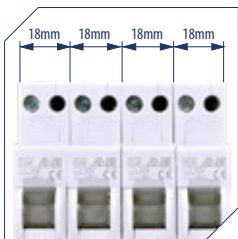

EITHER WAY UP

New universal KZS - 1M UNI enables top and bottom, line and load compatibility for easy, fast either-way-up installations.



All necessary technical and installation information can be found on the front and side of the device



Added protection against any pulsating DC component that can be generated from electrical appliances

Line voltage-dependent differential tripping (minimum supply voltage 85V)

Energy limiting class 3: highest energy limiting performance for optimal protection of cable insulation and maximally reducing risk of fire and other damage



The middle (trip) position of the toggle indicates electric fault tripping

The terminals accept not only wires but also time saving busbars

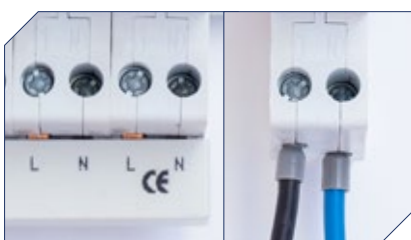

The possibility of connecting to SKN-type busbars

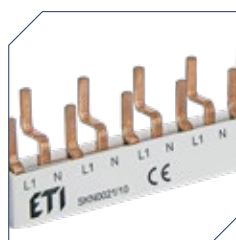

Easy removal from existing busbar system



ASTI / Residual Current Circuit Breakers with Integral Overcurrent Protection

- Real contact position indication for easier identification, whether RCBO is in ON or OFF position



- Clearly marked terminals ensure appropriate connection

- Increased opening on the N pole (size PZ2 screw drive)



- Sealing possibility



Recommended for use in installations with high level of additional protection required (bathrooms, hospitals, kindergartens etc). Used for fault and additional protection.

Residual current circuit breaker with integral overcurrent protection KZS -1M UNI

Rated short-circuit capacity
6 kA

Rated current
6 - 25 A

Tripping characteristic
B, C

Rated residual current
0,01 - 0,03 - 0,1 A

Description - KZS -1M UNI is a residual current circuit breaker with integral overcurrent protection, functionally dependent on line voltage.
Bi-directional connection.

Technical data

Type	KZS 1M UNI
Rated voltage U_n	230/240 V AC
Rated current I_n	6-25 A
Minimum supply voltage U_{min}	85 V
Rated frequency f_n	50/60 Hz
Rated short-circuit capacity	6.000 A
Back-up fuse	100 A gG
Tripping characteristic	B, C
Rated residual current $I_{\Delta n}$	10, 30, 100 mA
Type of residual release	A, AC
Rated residual making and breaking capacity $I_{\Delta n}$	1500A
Terminals	1-10 mm ² , max. 1,5Nm
Terminal screw	M4 (Pozidrive PZ2)
Width	18 mm
Mounting position	any
Standard	IEC 61009
Length of neutral conductor	-
Operating temperature	-35°C ... +40°C
Storage temperature	-40°C ... +60°C

Conductor cross-section [mm ²]	Number of single conductors, rigid, single-wire CU conductor					
	1	2	3	4	5	6
1,5	✓	✓	✓	✓	✓	✓
2,5	✓	✓	✓	✓	✓	✗
4	✓	✓	✓	✗	✗	✗
6	✓	✓	✗	✗	✗	✗
10	✓	✗	✗	✗	✗	✗

Remark: When you use more than 2 cables you have to be careful how those cables are inserted to ensure proper pressure on each cable

Conductor cross-section [mm ²]	Number of single conductors, flexible Cu conductors with cable ferrule					
	1	2	3	4	5	6
1,5	✓	✓	✓	✗	✗	✗
2,5	✓	✓	✗	✗	✗	✗
4	✓	✓	✗	✗	✗	✗
6	✓	✗	✗	✗	✗	✗
10	✓	✗	✗	✗	✗	✗

Combination of rigid single-wire and flexible multi-wire Cu conductors is not allowed

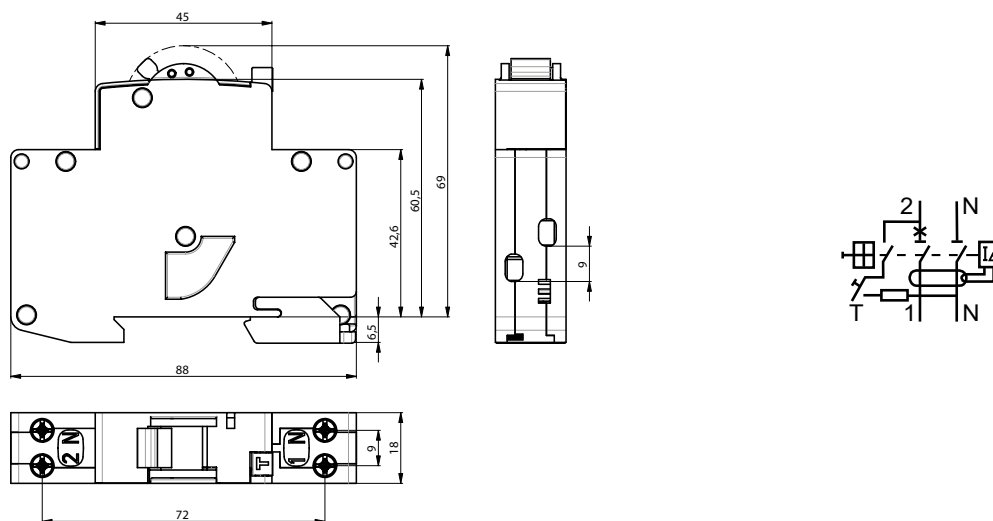



KZS - 1M UNI

I _n [A]	I _{Δn} [A]	Type A Characteristic B	Code No. B	Type A Characteristic C	Code No. C	g	Box
6	0,01	KZS-1M-UNI 1p+N A B6/0.01	002176001	KZS-1M-UNI 1p+N A C6/0.01	002176011	111	1/72
10		KZS-1M-UNI 1p+N A B10/0.01	002176002	KZS-1M-UNI 1p+N A C10/0.01	002176012		
13		KZS-1M-UNI 1p+N A B13/0.01	002176003	KZS-1M-UNI 1p+N A C13/0.01	002176013		
16		KZS-1M-UNI 1p+N A B16/0.01	002176004	KZS-1M-UNI 1p+N A C16/0.01	002176014		
20		KZS-1M-UNI 1p+N A B20/0.01	002176005	KZS-1M-UNI 1p+N A C20/0.01	002176015		
25		KZS-1M-UNI 1p+N A B25/0.01	002176006	KZS-1M-UNI 1p+N A C25/0.01	002176016		
6	0,03	KZS-1M-UNI 1p+N A B6/0.03	002176021	KZS-1M-UNI 1p+N A C6/0.03	002176031	111	1/72
10		KZS-1M-UNI 1p+N A B10/0.03	002176022	KZS-1M-UNI 1p+N A C10/0.03	002176032		
13		KZS-1M-UNI 1p+N A B13/0.03	002176023	KZS-1M-UNI 1p+N A C13/0.03	002176033		
16		KZS-1M-UNI 1p+N A B16/0.03	002176024	KZS-1M-UNI 1p+N A C16/0.03	002176034		
20		KZS-1M-UNI 1p+N A B20/0.03	002176025	KZS-1M-UNI 1p+N A C20/0.03	002176035		
25		KZS-1M-UNI 1p+N A B25/0.03	002176026	KZS-1M-UNI 1p+N A C25/0.03	002176036		
6	0,1	KZS-1M-UNI 1p+N A B6/0.1	002176041	KZS-1M-UNI 1p+N A C6/0.1	002176051	111	1/72
10		KZS-1M-UNI 1p+N A B10/0.1	002176042	KZS-1M-UNI 1p+N A C10/0.1	002176052		
13		KZS-1M-UNI 1p+N A B13/0.1	002176043	KZS-1M-UNI 1p+N A C13/0.1	002176053		
16		KZS-1M-UNI 1p+N A B16/0.1	002176044	KZS-1M-UNI 1p+N A C16/0.1	002176054		
20		KZS-1M-UNI 1p+N A B20/0.1	002176045	KZS-1M-UNI 1p+N A C20/0.1	002176055		
25		KZS-1M-UNI 1p+N A B25/0.1	002176046	KZS-1M-UNI 1p+N A C25/0.1	002176056		



KZS - 1M UNI

I_n [A]	$I_{\Delta n}$ [A]	Type AC Characteristic B	Code No. B	Type AC Characteristic C	Code No. C		
6	0,01	KZS-1M-UNI 1p+N AC B6/0.01	002176101	KZS-1M-UNI 1p+N AC C6/0.01	002176111	111	1/72
10		KZS-1M-UNI 1p+N AC B10/0.01	002176102	KZS-1M-UNI 1p+N AC C10/0.01	002176112		
13		KZS-1M-UNI 1p+N AC B13/0.01	002176103	KZS-1M-UNI 1p+N AC C13/0.01	002176113		
16		KZS-1M-UNI 1p+N AC B16/0.01	002176104	KZS-1M-UNI 1p+N AC C16/0.01	002176114		
20		KZS-1M-UNI 1p+N AC B20/0.01	002176105	KZS-1M-UNI 1p+N AC C20/0.01	002176115		
25		KZS-1M-UNI 1p+N AC B25/0.01	002176106	KZS-1M-UNI 1p+N AC C25/0.01	002176116		
6	0,03	KZS-1M-UNI 1p+N AC B6/0.03	002176121	KZS-1M-UNI 1p+N AC C6/0.03	002176131	111	1/72
10		KZS-1M-UNI 1p+N AC B10/0.03	002176122	KZS-1M-UNI 1p+N AC C10/0.03	002176132		
13		KZS-1M-UNI 1p+N AC B13/0.03	002176123	KZS-1M-UNI 1p+N AC C13/0.03	002176133		
16		KZS-1M-UNI 1p+N AC B16/0.03	002176124	KZS-1M-UNI 1p+N AC C16/0.03	002176134		
20		KZS-1M-UNI 1p+N AC B20/0.03	002176125	KZS-1M-UNI 1p+N AC C20/0.03	002176135		
25		KZS-1M-UNI 1p+N AC B25/0.03	002176126	KZS-1M-UNI 1p+N AC C25/0.03	002176136		
6	0,1	KZS-1M-UNI 1p+N AC B6/0.1	002176141	KZS-1M-UNI 1p+N AC C6/0.1	002176151	111	1/72
10		KZS-1M-UNI 1p+N AC B10/0.1	002176142	KZS-1M-UNI 1p+N AC C10/0.1	002176152		
13		KZS-1M-UNI 1p+N AC B13/0.1	002176143	KZS-1M-UNI 1p+N AC C13/0.1	002176153		
16		KZS-1M-UNI 1p+N AC B16/0.1	002176144	KZS-1M-UNI 1p+N AC C16/0.1	002176154		
20		KZS-1M-UNI 1p+N AC B20/0.1	002176145	KZS-1M-UNI 1p+N AC C20/0.1	002176155		
25		KZS-1M-UNI 1p+N AC B25/0.1	002176146	KZS-1M-UNI 1p+N AC C25/0.1	002176156		

Residual current circuit breaker with integral overcurrent protection KZS -1M FN

Rated short-circuit capacity
10 kA

Rated current
6 - 45 A

Tripping characteristic
B, C

Rated residual current
0,03 - 0,1 A

Description:

KZS -1M FN is a residual current circuit breaker with integral overcurrent protection, functionally dependent on line voltage.

It comes in a single pole version that switches the phase pole while the neutral pole stays fixed.

KZS 1M-FN is dependent on voltage and operates at voltages above 85V.



KZS 1M-FN also has a sealing possibility.

Technical data

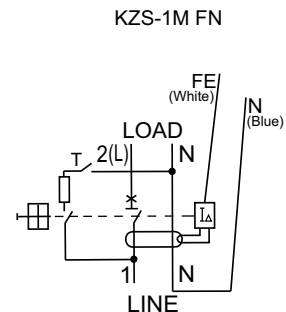
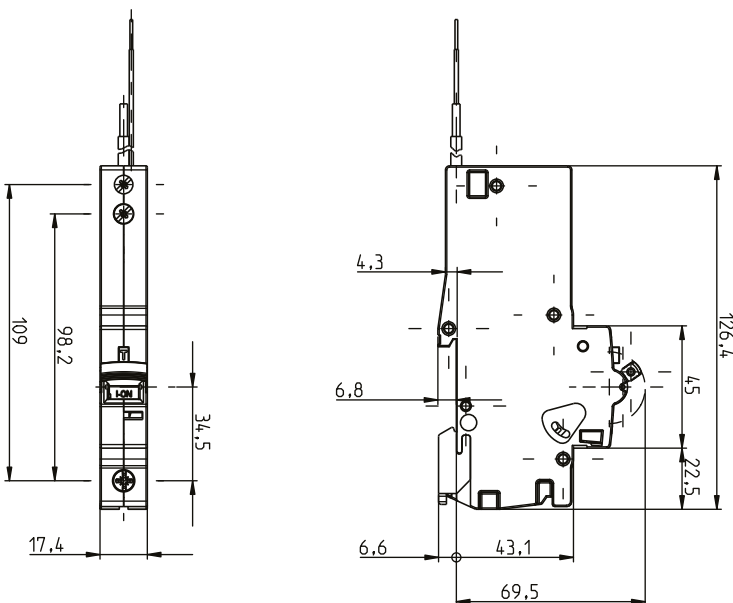

Type	KZS 1M FN
Rated voltage U_n	230 V AC
Rated current I_n	6-45 A
Minimal supply voltage U_{min}	90 V
Rated frequency f_n	50 Hz
Rated short-circuit capacity	10.000 A
Back-up fuse	100 A gG
Tripping characteristic	B, C
Rated residual current $I_{\Delta n}$	30, 100 mA
Type of residual release	A, AC
Rated residual making and breaking capacity $I_{\Delta m}$	4500A
Terminals	1-25 mm ² / 1-16 mm ²
Terminal screw	M5 (Pozidrive PZ2)
Width	18 mm
Mounting position	any
Standard	IEC 61009-1 / 61009-2
Length of neutral conductor	600 mm
Operating temperature	-25°C ... +40°C
Storage temperature	-40°C ... +60°C





KZS - 1M FN $I_{\Delta n} = 30$ mA

I_n [A]	$I_{\Delta n}$ [A]	Type A Characteristic C	Code No. B	Type A Characteristic C	Code No. C		
6	230	KZS-1M-FN A B6/0.03	002175581	KZS-1M-FN A C6/0.03	002175591	168	1/42
10		KZS-1M-FN A B10/0.03	002175582	KZS-1M-FN A C10/0.03	002175592	168	1/42
13		KZS-1M-FN A B13/0.03	002175583	KZS-1M-FN A C13/0.03	002175593	168	1/42
16		KZS-1M-FN A B16/0.03	002175584	KZS-1M-FN A C16/0.03	002175594	168	1/42
20		KZS-1M-FN A B20/0.03	002175585	KZS-1M-FN A C20/0.03	002175595	170	1/42
25		KZS-1M-FN A B25/0.03	002175586	KZS-1M-FN A C25/0.03	002175596	170	1/42
32		KZS-1M-FN A B32/0.03	002175587	KZS-1M-FN A C32/0.03	002175597	180	1/42
40		KZS-1M-FN A B40/0.03	002175588	KZS-1M-FN A C40/0.03	002175598	205	1/42
45		KZS-1M-FN A B45/0.03	002175589	KZS-1M-FN A C45/0.03	002175599	205	1/42



KZS - 1M FN AC $I_{\Delta n} = 30$ mA

I_n [A]	$I_{\Delta n}$ [A]	Type A Characteristic C	Code No. B	Type A Characteristic C	Code No. C		
6	230	KZS-1M-FN AC B6/0.03	002175501	KZS-1M-FN AC C6/0.03	002175521	168	1/42
10		KZS-1M-FN AC B10/0.03	002175502	KZS-1M-FN AC C10/0.03	002175522	168	1/42
13		KZS-1M-FN AC B13/0.03	002175503	KZS-1M-FN AC C13/0.03	002175523	168	1/42
16		KZS-1M-FN AC B16/0.03	002175504	KZS-1M-FN AC C16/0.03	002175524	168	1/42
20		KZS-1M-FN AC B20/0.03	002175505	KZS-1M-FN AC C20/0.03	002175525	170	1/42
25		KZS-1M-FN AC B25/0.03	002175506	KZS-1M-FN AC C25/0.03	002175526	170	1/42
32		KZS-1M-FN AC B32/0.03	002175507	KZS-1M-FN AC C32/0.03	002175527	180	1/42
40		KZS-1M-FN AC B40/0.03	002175508	KZS-1M-FN AC C40/0.03	002175528	205	1/42
45		KZS-1M-FN AC B45/0.03	002175509	KZS-1M-FN AC C45/0.03	002175529	205	1/42

KZS - 1M FN $I_{\Delta n} = 100$ mA

I_n [A]	$I_{\Delta n}$ [A]	Type A Characteristic C	Code No. B	Type A Characteristic C	Code No. C		
6	230	KZS-1M-FN A B6/0.1	002175781	KZS 1M-FN A C6/0.1	002175791	168	1/42
10		KZS-1M-FN A B10/0.1	002175782	KZS 1M-FN A C10/0.1	002175792	168	1/42
13		KZS-1M-FN A B13/0.1	002175783	KZS 1M-FN A C13/0.1	002175793	168	1/42
16		KZS-1M-FN A B16/0.1	002175784	KZS 1M-FN A C16/0.1	002175794	168	1/42
20		KZS-1M-FN A B20/0.1	002175785	KZS 1M-FN A C20/0.1	002175795	170	1/42
25		KZS-1M-FN A B25/0.1	002175786	KZS 1M-FN A C25/0.1	002175796	170	1/42
32		KZS-1M-FN A B32/0.1	002175787	KZS 1M-FN A C32/0.1	002175797	180	1/42
40		KZS-1M-FN A B40/0.1	002175788	KZS 1M-FN A C40/0.1	002175798	205	1/42
45		KZS-1M-FN A B45/0.1	002175789	KZS 1M-FN A C45/0.1	002175799	205	1/42

KZS - 1M FN AC $I_{\Delta n} = 100$ mA

I_n [A]	$I_{\Delta n}$ [A]	Type A Characteristic C	Code No. B	Type A Characteristic C	Code No. C		
6	230	KZS-1M-FN AC B6/0.1	002175511	KZS-1M-FN AC C6/0.1	002175531	168	1/42
10		KZS-1M-FN AC B10/0.1	002175512	KZS-1M-FN AC C10/0.1	002175532	168	1/42
13		KZS-1M-FN AC B13/0.1	002175513	KZS-1M-FN AC C13/0.1	002175533	168	1/42
16		KZS-1M-FN AC B16/0.1	002175514	KZS-1M-FN AC C16/0.1	002175534	168	1/42
20		KZS-1M-FN AC B20/0.1	002175515	KZS-1M-FN AC C20/0.1	002175535	170	1/42
25		KZS-1M-FN AC B25/0.1	002175516	KZS-1M-FN AC C25/0.1	002175536	170	1/42
32		KZS-1M-FN AC B32/0.1	002175517	KZS-1M-FN AC C32/0.1	002175537	180	1/42
40		KZS-1M-FN AC B40/0.1	002175518	KZS-1M-FN AC C40/0.1	002175538	205	1/42
45		KZS-1M-FN AC B45/0.1	002175519	KZS-1M-FN AC C45/0.1	002175539	205	1/42



Can be used with auxiliary / signal switch
PS/SS (001908421) - page 47

Time current characteristics I/t, KZS-1M

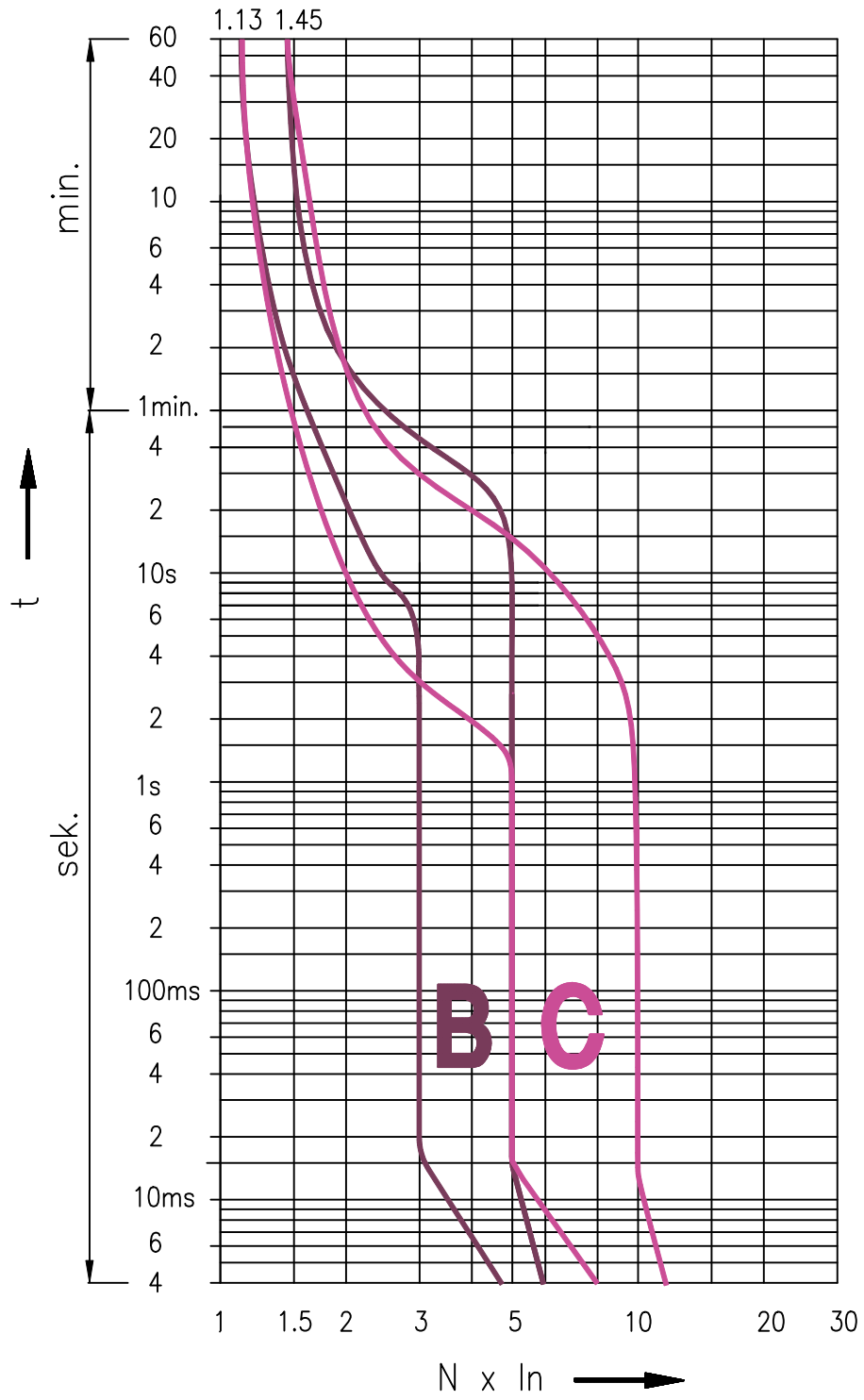

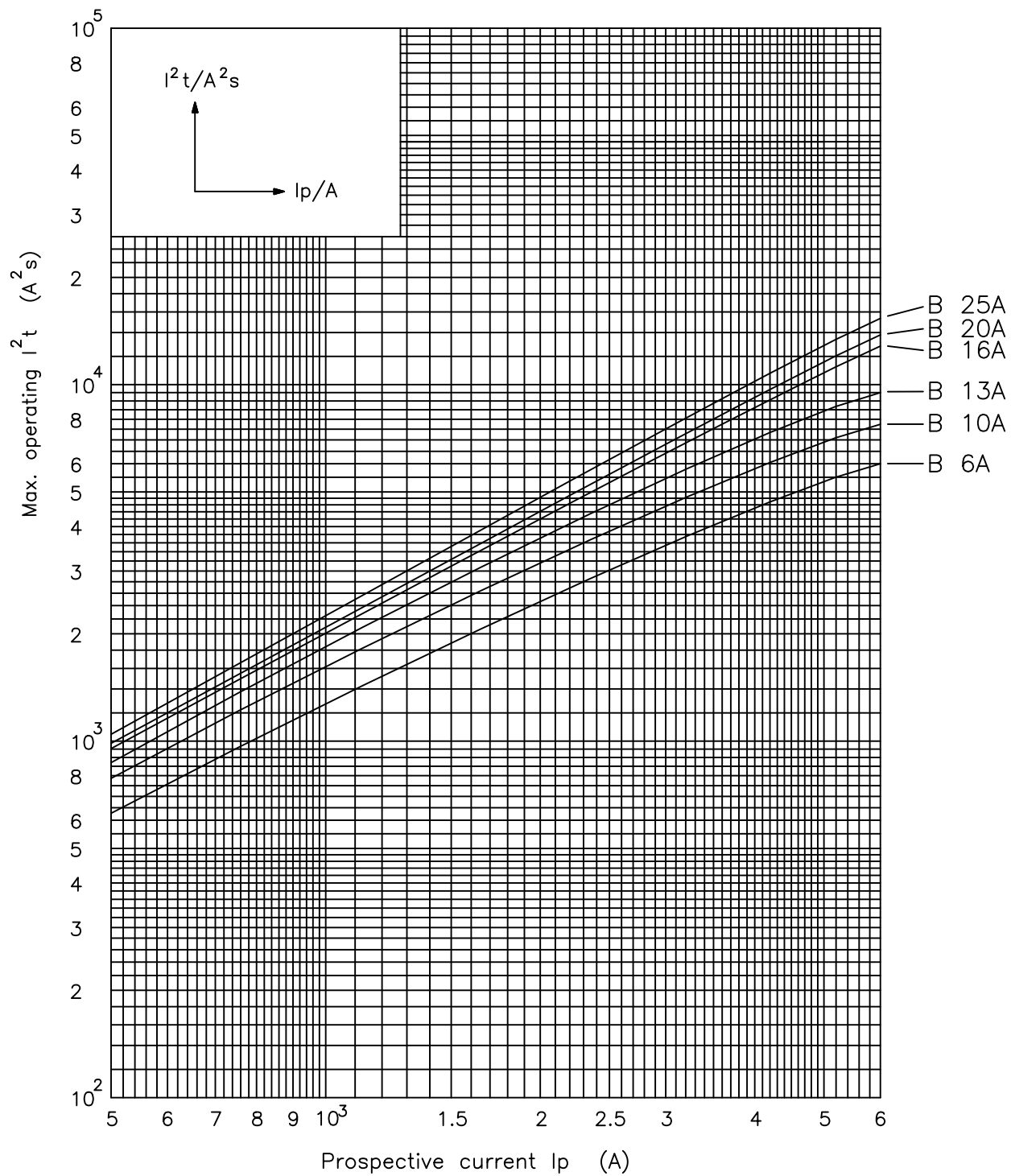
Melting energy characteristics I^2t KZS-1M

Melting energy characteristics I²t KZS-1M

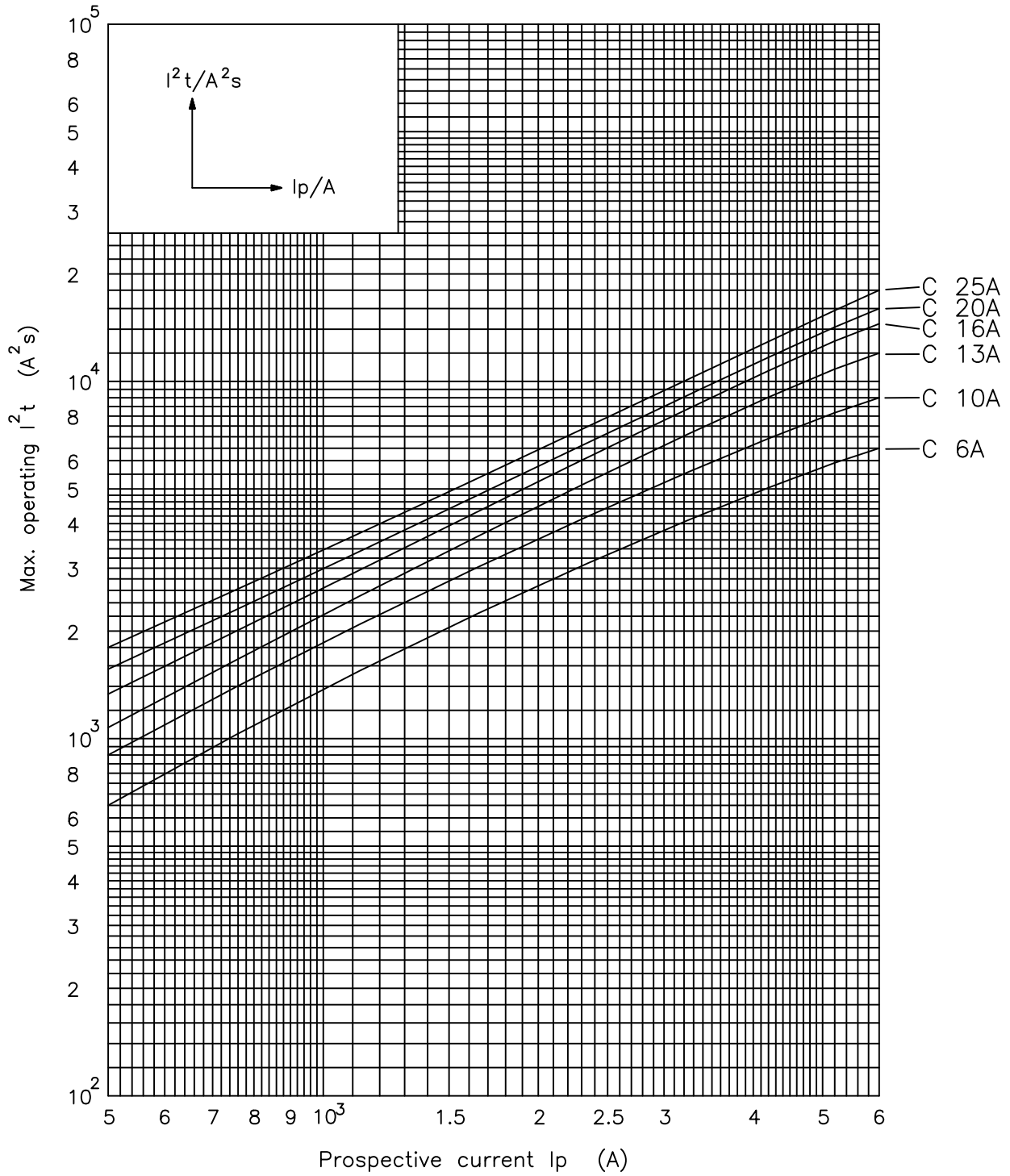

Cut-off current characteristics KZS-1M

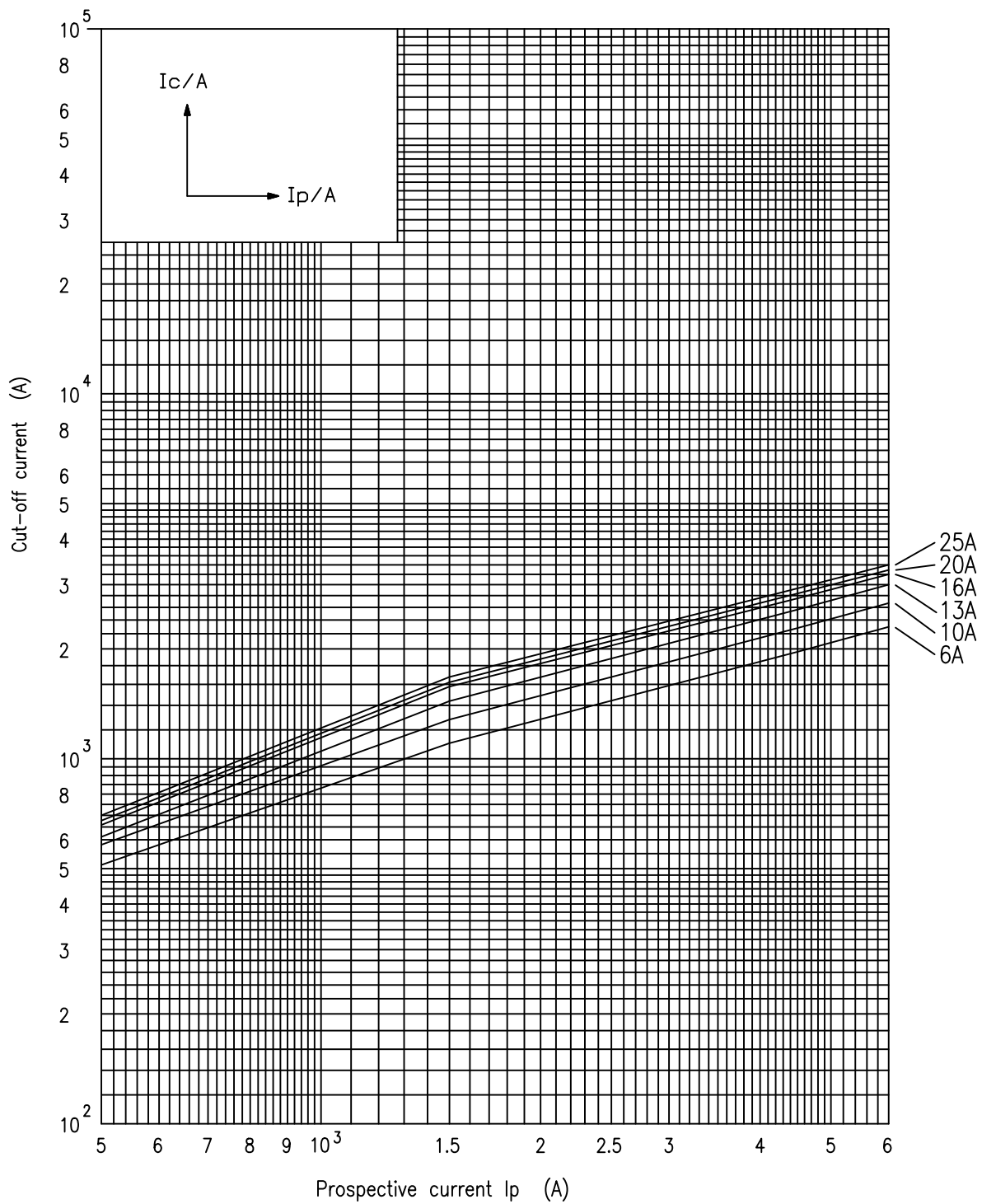

Residual current circuit breaker with integral overcurrent protection KZS -2M, 4M

/// All necessary technical and installation information can be found on the front and side of the device



/// Special versions (with LED status signalisation, B type, AFDD type) available



/// The terminals accept not only wires but also time saving busbars
/// Supply is possible both from top and bottom terminals



/// Auxiliary switch PS KZS-2M/4M for KZS-2M, KZS-4M

/// Test button enables user to check residual functionality



/// Sealing possibility in "ON/OFF" position



/// Real contact position indication for easier identification, whether RCBO is in ON or OFF position

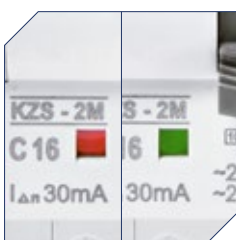

/// Clearly marked terminals ensure appropriate connection

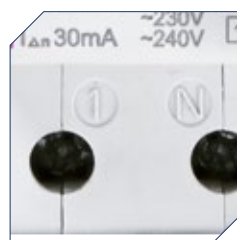

/// Better protection of terminals against touching the parts under voltage



Residual current circuit breaker with integral overcurrent protection KZS-2M

Rated short-circuit capacity
10 kA

Rated current
6 - 40 A

Tripping characteristic
B, C

Rated residual current
0,01 - 0,5 A

Description: KZS (KZS-2M, KZS-4M) is a residual current circuit breaker combining the features of a miniature circuit breaker and a residual current circuit breaker and is functionally independent on line voltage. Used primarily in circuits with an increased requirements regarding touch voltage such as circuits of portable appliances, in kindergartens, schools, hospitals etc.

Technical data

Type	INST	G/KV	120 V
Rated voltage U_n	230/240 V AC		
Rated current I_n	6-40 A		
Rated frequency f_n	50 Hz	60 Hz	
Rated impulse withstand voltage U_{imp}	4 kV		
Rated short-circuit capacity	10.000 A		
Back-up fuse	100 A gG		
Voltage range test circuit	180-200 V	90-143 V	
Tripping characteristic	B, C		
Energy limiting class	3		
Type	A, AC		A
Rated residual current $I_{\Delta n}$	10, 30, 100, 300, 500 mA	30 mA	
Peak withstand current	250 A	3 kA	
Rated residual making and breaking capacity $I_{\Delta m}$	10.000A		
Terminals	1-25 mm ² , max. 3Nm		
Terminal screw	M5 (Pozidrive PZ2)		
Rated insulation Voltage U_i	500 V		
Peak withstand current	250 A		
Degree of protection	IP20		
Busbar thickness	0,8 - 2 mm		
Operating temperature	-25°C ... +60°C		
Storage temperature	-40°C ... +70°C		
Width	36 mm		
Mounting position	any		
Resistance to vibrations acc. to IEC 60068-2-7	5g (10,60 & 500Hz)		
Standard	IEC 61009, EN 61009		

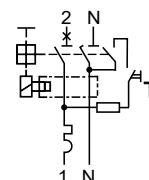

KZS-2M $I_{\Delta n} = 10 \text{ mA}$

I_n [A]	Type A Characteristic B	Code No. B	Type A Characteristic C	Code No. C		
6	KZS-2M A B6/0.01	002173211	KZS-2M A C6/0.01	002173231	225	1/54
10	KZS-2M A B10/0.01	002173212	KZS-2M A C10/0.01	002173232	225	1/54
13	KZS-2M A B13/0.01	002173213	KZS-2M A C13/0.01	002173233	225	1/54
16	KZS-2M A B16/0.01	002173214	KZS-2M A C16/0.01	002173234	225	1/54
20	KZS-2M A B20/0.01	002173215	KZS-2M A C20/0.01	002173235	225	1/54
25	KZS-2M A B25/0.01	002173216	KZS-2M A C25/0.01	002173236	225	1/54
32	KZS-2M A B32/0.01	002173217	KZS-2M A C32/0.01	002173237	225	1/54
40	KZS-2M A B40/0.01	002173218	KZS-2M A C40/0.01	002173238	225	1/54

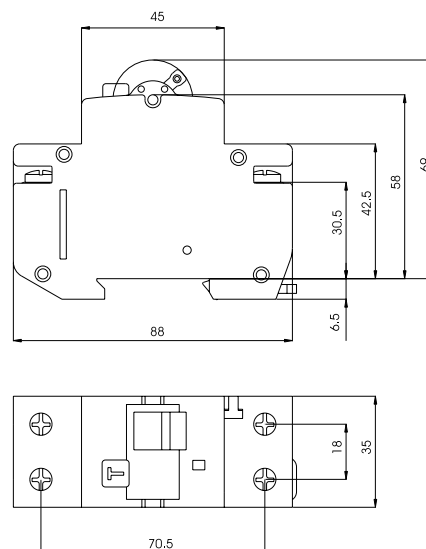

KZS-2M $I_{\Delta n} = 30 \text{ mA}$

I_n [A]	Type A Characteristic B	Code No. B	Type A Characteristic C	Code No. C		
6	KZS-2M A B6/0.03	002173201	KZS-2M A C6/0.03	002173221	225	1/54
10	KZS-2M A B10/0.03	002173202	KZS-2M A C10/0.03	002173222	225	1/54
13	KZS-2M A B13/0.03	002173203	KZS-2M A C13/0.03	002173223	225	1/54
16	KZS-2M A B16/0.03	002173204	KZS-2M A C16/0.03	002173224	225	1/54
20	KZS-2M A B20/0.03	002173205	KZS-2M A C20/0.03	002173225	225	1/54
25	KZS-2M A B25/0.03	002173206	KZS-2M A C25/0.03	002173226	225	1/54
32	KZS-2M A B32/0.03	002173207	KZS-2M A C32/0.03	002173227	225	1/54
40	KZS-2M A B40/0.03	002173208	KZS-2M A C40/0.03	002173228	225	1/54

KZS-2M $I_{\Delta n} = 30 \text{ mA}$

I_n [A]	Type AC Characteristic B	Code No. B	Type AC Characteristic C	Code No. C		
6	KZS-2M AC B6/0.03	002173101	KZS-2M AC C6/0.03	002173121	225	1/54
10	KZS-2M AC B10/0.03	002173102	KZS-2M AC C10/0.03	002173122	225	1/54
13	KZS-2M AC B13/0.03	002173103	KZS-2M AC C13/0.03	002173123	225	1/54
16	KZS-2M AC B16/0.03	002173104	KZS-2M AC C16/0.03	002173124	225	1/54
20	KZS-2M AC B20/0.03	002173105	KZS-2M AC C20/0.03	002173125	225	1/54
25	KZS-2M AC B25/0.03	002173106	KZS-2M AC C25/0.03	002173126	225	1/54
32	KZS-2M AC B32/0.03	002173107	KZS-2M AC C32/0.03	002173127	225	1/54
40	KZS-2M AC B40/0.03	002173108	KZS-2M AC C40/0.03	002173128	225	1/54

KZS-2M $I_{\Delta n} = 100 \text{ mA}$

I_n [A]	Type A Characteristic B	Code No. B	Type A Characteristic C	Code No. C		
6	KZS-2M A B6/0.1	002173701	KZS-2M A C6/0.1	002173721	225	1/54
10	KZS-2M A B10/0.1	002173702	KZS-2M A C10/0.1	002173722	225	1/54
13	KZS-2M A B13/0.1	002173703	KZS-2M A C13/0.1	002173723	225	1/54
16	KZS-2M A B16/0.1	002173704	KZS-2M A C16/0.1	002173724	225	1/54
20	KZS-2M A B20/0.1	002173705	KZS-2M A C20/0.1	002173725	225	1/54
25	KZS-2M A B25/0.1	002173706	KZS-2M A C25/0.1	002173726	225	1/54
32	KZS-2M A B32/0.1	002173707	KZS-2M A C32/0.1	002173727	225	1/54
40	KZS-2M A B40/0.1	002173708	KZS-2M A C40/0.1	002173728	225	1/54

KZS-2M $I_{\Delta n} = 300 \text{ mA}$



I_n [A]	Type A Characteristic B	Code No. B	Type A Characteristic C	Code No. C		
6	KZS-2M A B6/0.3	002173401	KZS-2M A C6/0.3	002173421	225	1/54
10	KZS-2M A B10/0.3	002173402	KZS-2M A C10/0.3	002173422	225	1/54
13	KZS-2M A B13/0.3	002173403	KZS-2M A C13/0.3	002173423	225	1/54
16	KZS-2M A B16/0.3	002173404	KZS-2M A C16/0.3	002173424	225	1/54
20	KZS-2M A B20/0.3	002173405	KZS-2M A C20/0.3	002173425	225	1/54
25	KZS-2M A B25/0.3	002173406	KZS-2M A C25/0.3	002173426	225	1/54
32	KZS-2M A B32/0.3	002173407	KZS-2M A C32/0.3	002173427	225	1/54
40	KZS-2M A B40/0.3	002173408	KZS-2M A C40/0.3	002173428	225	1/54

KZS-2M $I_{\Delta n} = 300 \text{ mA}$



I_n [A]	Type AC Characteristic B	Code No. B	Type AC Characteristic C	Code No. C		
6	KZS-2M AC B6/0.3	002173301	KZS-2M AC C6/0.3	002173321	225	1/54
10	KZS-2M AC B10/0.3	002173302	KZS-2M AC C10/0.3	002173322	225	1/54
13	KZS-2M AC B13/0.3	002173303	KZS-2M AC C13/0.3	002173323	225	1/54
16	KZS-2M AC B16/0.3	002173304	KZS-2M AC C16/0.3	002173324	225	1/54
20	KZS-2M AC B20/0.3	002173305	KZS-2M AC C20/0.3	002173325	225	1/54
25	KZS-2M AC B25/0.3	002173306	KZS-2M AC C25/0.3	002173326	225	1/54
32	KZS-2M AC B32/0.3	002173307	KZS-2M AC C32/0.3	002173327	225	1/54
40	KZS-2M AC B40/0.3	002173308	KZS-2M AC C40/0.3	002173328	225	1/54





KZS-2M $I_{\Delta n} = 500 \text{ mA}$

I_n [A]	Type A Characteristic B	Code No. B	Type A Characteristic C	Code No. C		
6	KZS-2M A B6/0.5	002173901	KZS-2M A C6/0.5	002173921	225	1/54
10	KZS-2M A B10/0.5	002173902	KZS-2M A C10/0.5	002173922	225	1/54
13	KZS-2M A B13/0.5	002173903	KZS-2M A C13/0.5	002173923	225	1/54
16	KZS-2M A B16/0.5	002173904	KZS-2M A C16/0.5	002173924	225	1/54
20	KZS-2M A B20/0.5	002173905	KZS-2M A C20/0.5	002173925	225	1/54
25	KZS-2M A B25/0.5	002173906	KZS-2M A C25/0.5	002173926	225	1/54
32	KZS-2M A B32/0.5	002173907	KZS-2M A C32/0.5	002173927	225	1/54
40	KZS-2M A B40/0.5	002173908	KZS-2M A C40/0.5	002173928	225	1/54

**KZS-2M G/KV type $I_{\Delta n} = 30 \text{ mA}$**

I_n [A]	Type A, G/KV Characteristic B	Code No. B	Type A, G/KV Characteristic C	Code No. C		
6	KZS-2M A G/KV B6/0.03	002174101	KZS-2M A G/KV C6/0.03	002174121	225	1/54
10	KZS-2M A G/KV B10/0.03	002174102	KZS-2M A G/KV C10/0.03	002174122	225	1/54
13	KZS-2M A G/KV B13/0.03	002174103	KZS-2M A G/KV C13/0.03	002174123	225	1/54
16	KZS-2M A G/KV B16/0.03	002174104	KZS-2M A G/KV C16/0.03	002174124	225	1/54
20	KZS-2M A G/KV B20/0.03	002174105	KZS-2M A G/KV C20/0.03	002174125	225	1/54
25	KZS-2M A G/KV B25/0.03	002174106	KZS-2M A G/KV C25/0.03	002174126	225	1/54
32	KZS-2M A G/KV B32/0.03	002174107	KZS-2M A G/KV C32/0.03	002174127	225	1/54
40	KZS-2M A G/KV B40/0.03	002174108	KZS-2M A G/KV C40/0.03	002174128	225	1/54

**KZS-2M 120 V type $I_{\Delta n} = 30 \text{ mA}$**

I_n [A]	Type A, 120 V Characteristic B	Code No. B	Type A, 120 V Characteristic C	Code No. C		
6	KZS-2M A B6/0.03 120V	002173351	KZS-2M A C6/0.03 120V	002173391	225	1/54
10	KZS-2M A B10/0.03 120V	002173352	KZS-2M A C10/0.03 120V	002173392	225	1/54
13	KZS-2M A B13/0.03 120V	002173353	KZS-2M A C13/0.03 120V	002173393	225	1/54
16	KZS-2M A B16/0.03 120V	002173354	KZS-2M A C16/0.03 120V	002173394	225	1/54
20	KZS-2M A B20/0.03 120V	002173355	KZS-2M A C20/0.03 120V	002173395	225	1/54
25	KZS-2M A B25/0.03 120V	002173356	KZS-2M A C25/0.03 120V	002173396	225	1/54
32	KZS-2M A B32/0.03 120V	002173357	KZS-2M A C32/0.03 120V	002173397	225	1/54
40	KZS-2M A B40/0.03 120V	002173358	KZS-2M A C40/0.03 120V	002173398	225	1/54

Conductor cross-section [mm ²]	Number of single conductors, rigid, single-wire CU conductor				
	1	2	3	4	5
1,5	✓	✓	✓	✓	✗
2,5	✓	✓	✓	✗	✗
4	✓	✓	✓	✗	✗
6	✓	✓	✗	✗	✗
10	✓	✓	✗	✗	✗
16	✓	✗	✗	✗	✗
25	✓	✗	✗	✗	✗

Remark: When you use more than 2 cables you have to be careful how those cables are inserted to ensure proper pressure on each cable

Conductor cross-section [mm ²]	Number of single conductors, flexible Cu conductors with cable ferrule					
	1	2	3	4	5	6
1,5	✓	✓	✓	✓	✓	✓
2,5	✓	✓	✓	✓	✓	✓
4	✓	✓	✓	✓	✓	✓
6	✓	✓	✓	✗	✗	✗
10	✓	✓	✗	✗	✗	✗
16	✓	✗	✗	✗	✗	✗
25	✓	✗	✗	✗	✗	✗

Combination of rigid single-wire and flexible multi-wire Cu conductors is not allowed

Residual current circuit breaker with integral overcurrent protection KZS-2M 2p

Rated short-circuit capacity
10 kA

Rated current
6 - 25 A

Tripping characteristic
B, C

Rated residual current
0,03 A

Technical data

Rated voltage U_n	230 V AC
Rated current I_n	6-25 A
Rated frequency f_n	50 Hz
Rated short-circuit capacity	10.000 A
Back-up fuse	100 A gG
Tripping characteristic	B, C
Type	A
Rated residual current $I_{\Delta n}$	30, 100 mA
Rated residual making and breaking capacity $I_{\Delta m}$	1500A
Terminals	1-25 mm ² , max. 3Nm
Terminal screw	M5 (Pozidrive PZ2)
Rated insulation Voltage U_i	500 V
Peak withstand current	250 A
Degree of protection	IP20
Busbar thickness	0,8 - 2 mm
Operating temperature	-25°C ... +60°C
Storage temperature	-40°C ... +70°C
Width	36 mm
Mounting position	any
Resistance to vibrations acc. to IEC 60068-2-7	5g (10,60 & 500Hz)
Standard	IEC 61009, EN 61009

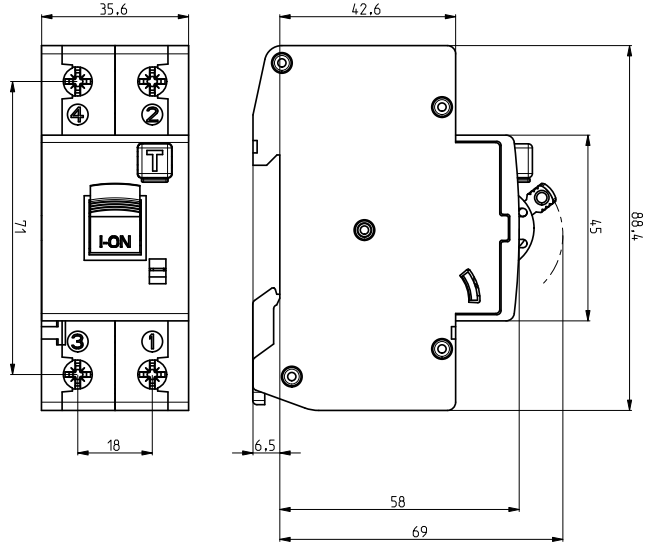

KZS-2M 2p $I_{\Delta n} = 30 \text{ mA}$

I_n [A]	Type A Characteristic B	Code No. B	Type A Characteristic C	Code No. C		
6	KZS-2M2p A B6/0.03	002172501	KZS-2M2p A C6/0.03	002172521	210	1/54
10	KZS-2M2p A B10/0.03	002172502	KZS-2M2p A C10/0.03	002172522	210	1/54
13	KZS-2M2p A B13/0.03	002172503	KZS-2M2p A C13/0.03	002172523	210	1/54
15	KZS-2M2p A B15/0.03	002172504	KZS-2M2p A C15/0.03	002172524	210	1/54
16	KZS-2M2p A B16/0.03	002172505	KZS-2M2p A C16/0.03	002172525	210	1/54
20	KZS-2M2p A B20/0.03	002172506	KZS-2M2p A C20/0.03	002172526	210	1/54
25	KZS-2M2p A B25/0.03	002172507	KZS-2M2p A C25/0.03	002172527	210	1/54



KZS-2M 2p $I_{\Delta n} = 100 \text{ mA}$

I_n [A]	Type A Characteristic B	Code No. B	Type A Characteristic C	Code No. C		
6	KZS-2M2p A B6/0.1	002172471	KZS-2M2p A C6/0.1	002172481	210	1/54
10	KZS-2M2p A B10/0.1	002172472	KZS-2M2p A C10/0.1	002172482	210	1/54
13	KZS-2M2p A B13/0.1	002172473	KZS-2M2p A C13/0.1	002172483	210	1/54
15	KZS-2M2p A B15/0.1	002172474	KZS-2M2p A C15/0.1	002172484	210	1/54
16	KZS-2M2p A B16/0.1	002172475	KZS-2M2p A C16/0.1	002172485	210	1/54
20	KZS-2M2p A B20/0.1	002172476	KZS-2M2p A C20/0.1	002172486	210	1/54
25	KZS-2M2p A B25/0.1	002172477	KZS-2M2p A C25/0.1	002172487	210	1/54

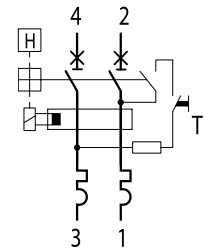

RCBO with LED status signalisation KZS 2M2p EDI

Rated short-circuit capacity
10 kA

Rated current
6 - 25 A

Tripping characteristic
B, C

Rated residual current
0,03 A

Easy and clear identification of the device status:

LED signalisation enables an exact information on which type of fault caused the tripping (red light for overload / short circuit, yellow light for residual current and green for manual operation)

Indication of internal contact position for quick and exact identification of the states of contacts (green for open contacts, red for closed contacts)

Technical data

Rated voltage U_n	~230 V AC
Rated current I_n	6-25 A
Rated frequency f_n	50 Hz
Minimal supply voltage U_{min}	90 V
Min. LED operating voltage U_{min}	150 V
Rated short-circuit capacity	10.000 A
Back-up fuse	100 A gG
Tripping characteristic	B, C
Energy limiting class	3
Type of residual release	A
Rated residual current $I_{\Delta n}$	30 mA
Rated residual making and breaking capacity $I_{\Delta m}$	1500A
Index of protection	IP20
Overvoltage category	III
Ambient temperature	-25 °C ... +40 °C
Storage temperature	-40 °C ... +70 °C
Mounting position	any
Terminals	1-25 mm ² , max. 3 Nm
Terminal screw	M5 (Pozidrive PZ2)
Width	36 mm
Resistance to vibrations acc. to IEC 60068-2-7	5g (10,60 & 500Hz)
Standard	IEC 61009-2, IEC 61009-1



/// KZS EDI - "ON"



/// KZS EDI - "OFF" manual operation (green LED)



/// KZS EDI - "OFF" RCD tripped (yellow LED)



/// KZS EDI - "OFF" MCB tripped (Red LED)

KZS-2M 2p EDI $I_{\Delta n} = 30 \text{ mA}$

I_n [A]	Type A Characteristic B	Code No. B	Type A Characteristic C	Code No. C		
6	KZS-2M2p EDI A B6/0.03	002172401	KZS-2M2p EDI A C6/0.03	002172411	205	1/54
10	KZS-2M2p EDI A B10/0.03	002172402	KZS-2M2p EDI A C10/0.03	002172412	205	1/54
13	KZS-2M2p EDI A B13/0.03	002172403	KZS-2M2p EDI A C13/0.03	002172413	205	1/54
15	KZS-2M2p EDI A B15/0.03	002172404	KZS-2M2p EDI A C15/0.03	002172414	205	1/54
16	KZS-2M2p EDI A B16/0.03	002172406	KZS-2M2p EDI A C16/0.03	002172416	205	1/54
20	KZS-2M2p EDI A B20/0.03	002172407	KZS-2M2p EDI A C20/0.03	002172417	205	1/54
25	KZS-2M2p EDI A B25/0.03	002172408	KZS-2M2p EDI A C25/0.03	002172418	205	1/54



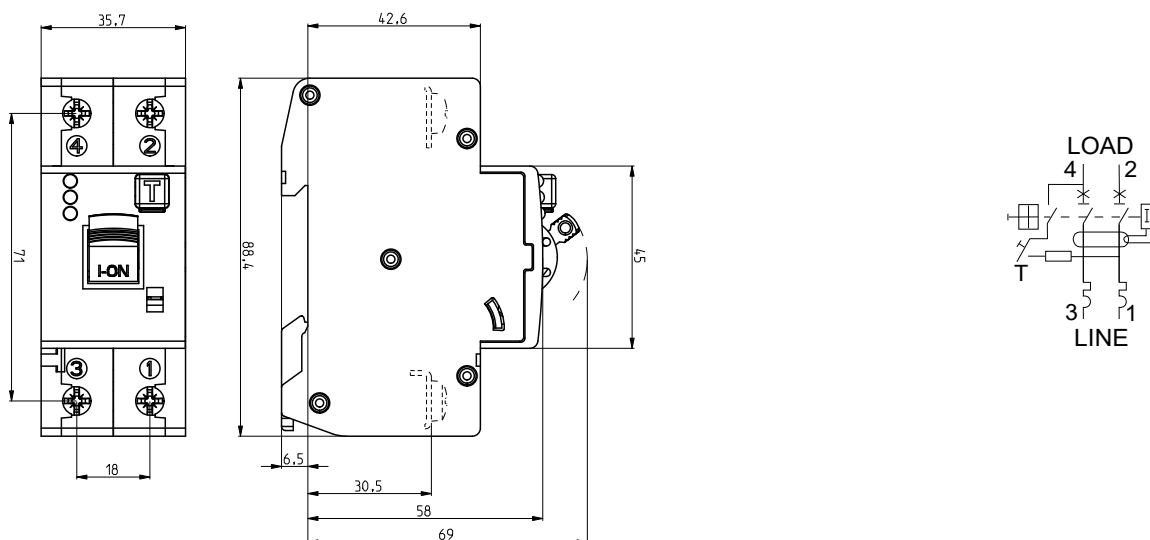

Residual current circuit breaker with integral overcurrent protection KZS-4M 3p

Rated short-circuit capacity 10 kA	Rated current 6 - 32 A	Tripping characteristic B, C	Rated residual current 0,03 A - 0,5 A
--	----------------------------------	--	---

Technical data

Rated voltage U_n	~400 V AC
Rated current I_n	6-32 A
Rated frequency f_n	50/60 Hz
Rated short-circuit capacity	10.000 A
Back-up fuse	100 A gG
Tripping characteristic	B, C
Type	AC, A
Rated residual current $I_{\Delta n}$	30, 100, 300, 500 mA
Rated residual making and breaking capacity $I_{\Delta m}$	4500A
Terminals	1-25 mm ² , max. 3 Nm
Terminal screw	M5 (PoziDrive PZ2)
Rated insulation Voltage U_i	500 V
Peak withstand current	250 A
Resistance according to vibrations acc. to IEC 60068-2-7	5g (10, 60 & 500Hz)
Degree of protection	IP20
Busbar thickness	0,8 - 2 mm
Operating temperature	-25°C ... +60°C
Storage temperature	-40°C ... +70°C
Width	72 mm
Mounting position	any
Standard	EN 61009-1

KZS-4M 3p $I_{\Delta n} = 30 \text{ mA}$

I_n [A]	Type A	Code No. B	Type A	Code No. C	g	Box
	Characteristic B		Characteristic C			
6	KZS-4M 3p A B6/0.03	002174701	KZS-4M 3p A C6/0.03	002174721	482	1/27
10	KZS-4M 3p A B10/0.03	002174702	KZS-4M 3p A C10/0.03	002174722	482	1/27
13	KZS-4M 3p A B13/0.03	002174703	KZS-4M 3p A C13/0.03	002174723	482	1/27
16	KZS-4M 3p A B16/0.03	002174704	KZS-4M 3p A C16/0.03	002174724	482	1/27
20	KZS-4M 3p A B20/0.03	002174705	KZS-4M 3p A C20/0.03	002174725	482	1/27
25	KZS-4M 3p A B25/0.03	002174706	KZS-4M 3p A C25/0.03	002174726	482	1/27
32	KZS-4M 3p A B32/0.03	002174707	KZS-4M 3p A C32/0.03	002174727	482	1/27



KZS-4M 3p I_{Δn} = 30 mA

I _n [A]	Type AC Characteristic B	Code No. B	Type AC Characteristic C	Code No. C	g	
6	KZS-4M 3p AC B6/0.03	002174801	KZS-4M 3p AC C6/0.03	002174821	482	1/27
10	KZS-4M 3p AC B10/0.03	002174802	KZS-4M 3p AC C10/0.03	002174822	482	1/27
13	KZS-4M 3p AC B13/0.03	002174803	KZS-4M 3p AC C13/0.03	002174823	482	1/27
16	KZS-4M 3p AC B16/0.03	002174804	KZS-4M 3p AC C16/0.03	002174824	482	1/27
20	KZS-4M 3p AC B20/0.03	002174805	KZS-4M 3p AC C20/0.03	002174825	482	1/27
25	KZS-4M 3p AC B25/0.03	002174806	KZS-4M 3p AC C25/0.03	002174826	482	1/27
32	KZS-4M 3p AC B32/0.03	002174807	KZS-4M 3p AC C32/0.03	002174827	482	1/27

**KZS-4M 3p I_{Δn} = 30 mA**

I _n [A]	Type A Characteristic B	Code No. B	Type A Characteristic C	Code No. C	g	
6	KZS-4M 3p A B6/0.03	002174701	KZS-4M 3p A C6/0.03	002174721	482	1/27
10	KZS-4M 3p A B10/0.03	002174702	KZS-4M 3p A C10/0.03	002174722	482	1/27
13	KZS-4M 3p A B13/0.03	002174703	KZS-4M 3p A C13/0.03	002174723	482	1/27
16	KZS-4M 3p A B16/0.03	002174704	KZS-4M 3p A C16/0.03	002174724	482	1/27
20	KZS-4M 3p A B20/0.03	002174705	KZS-4M 3p A C20/0.03	002174725	482	1/27
25	KZS-4M 3p A B25/0.03	002174706	KZS-4M 3p A C25/0.03	002174726	482	1/27
32	KZS-4M 3p A B32/0.03	002174707	KZS-4M 3p A C32/0.03	002174727	482	1/27

**KZS-4M 3p I_{Δn} = 30 mA**

I _n [A]	Type AC Characteristic B	Code No. B	Type AC Characteristic C	Code No. C	g	
6	KZS-4M 3p AC B6/0.03	002174801	KZS-4M 3p AC C6/0.03	002174821	482	1/27
10	KZS-4M 3p AC B10/0.03	002174802	KZS-4M 3p AC C10/0.03	002174822	482	1/27
13	KZS-4M 3p AC B13/0.03	002174803	KZS-4M 3p AC C13/0.03	002174823	482	1/27
16	KZS-4M 3p AC B16/0.03	002174804	KZS-4M 3p AC C16/0.03	002174824	482	1/27
20	KZS-4M 3p AC B20/0.03	002174805	KZS-4M 3p AC C20/0.03	002174825	482	1/27
25	KZS-4M 3p AC B25/0.03	002174806	KZS-4M 3p AC C25/0.03	002174826	482	1/27
32	KZS-4M 3p AC B32/0.03	002174807	KZS-4M 3p AC C32/0.03	002174827	482	1/27

**KZS-4M 3p I_{Δn} = 100 mA**

I _n [A]	Type A Characteristic B	Code No. B	Type A Characteristic C	Code No. C	g	
6	KZS-4M 3p A B6/0.1	002173001	KZS-4M 3p A C6/0.1	002173021	482	1/27
10	KZS-4M 3p A B10/0.1	002173002	KZS-4M 3p A C10/0.1	002173022	482	1/27
13	KZS-4M 3p A B13/0.1	002173003	KZS-4M 3p A C13/0.1	002173023	482	1/27
16	KZS-4M 3p A B16/0.1	002173004	KZS-4M 3p A C16/0.1	002173024	482	1/27
20	KZS-4M 3p A B20/0.1	002173005	KZS-4M 3p A C20/0.1	002173025	482	1/27
25	KZS-4M 3p A B25/0.1	002173006	KZS-4M 3p A C25/0.1	002173026	482	1/27
32	KZS-4M 3p A B32/0.1	002173007	KZS-4M 3p A C32/0.1	002173027	482	1/27

KZS-4M 3p I_{Δn} = 300 mA

I _n [A]	Type A Characteristic B	Code No. B	Type A Characteristic C	Code No. C	g	Box
6	KZS-4M 3p A B6/0.3	002174201	KZS-4M 3p A C6/0.3	002174221	482	1/27
10	KZS-4M 3p A B10/0.3	002174202	KZS-4M 3p A C10/0.3	002174222	482	1/27
13	KZS-4M 3p A B13/0.3	002174203	KZS-4M 3p A C13/0.3	002174223	482	1/27
16	KZS-4M 3p A B16/0.3	002174204	KZS-4M 3p A C16/0.3	002174224	482	1/27
20	KZS-4M 3p A B20/0.3	002174205	KZS-4M 3p A C20/0.3	002174225	482	1/27
25	KZS-4M 3p A B25/0.3	002174206	KZS-4M 3p A C25/0.3	002174226	482	1/27
32	KZS-4M 3p A B32/0.3	002174207	KZS-4M 3p A C32/0.3	002174227	482	1/27



KZS-4M 3p I_{Δn} = 500 mA

I _n [A]	Type A Characteristic B	Code No. B	Type A Characteristic C	Code No. C	g	Box
6	KZS-4M 3p A B6/0.5	002174301	KZS-4M 3p A C6/0.5	002174321	482	1/27
10	KZS-4M 3p A B10/0.5	002174302	KZS-4M 3p A C10/0.5	002174322	482	1/27
13	KZS-4M 3p A B13/0.5	002174303	KZS-4M 3p A C13/0.5	002174323	482	1/27
16	KZS-4M 3p A B16/0.5	002174304	KZS-4M 3p A C16/0.5	002174324	482	1/27
20	KZS-4M 3p A B20/0.5	002174305	KZS-4M 3p A C20/0.5	002174325	482	1/27
25	KZS-4M 3p A B25/0.5	002174306	KZS-4M 3p A C25/0.5	002174326	482	1/27
32	KZS-4M 3p A B32/0.5	002174307	KZS-4M 3p A C32/0.5	002174327	482	1/27

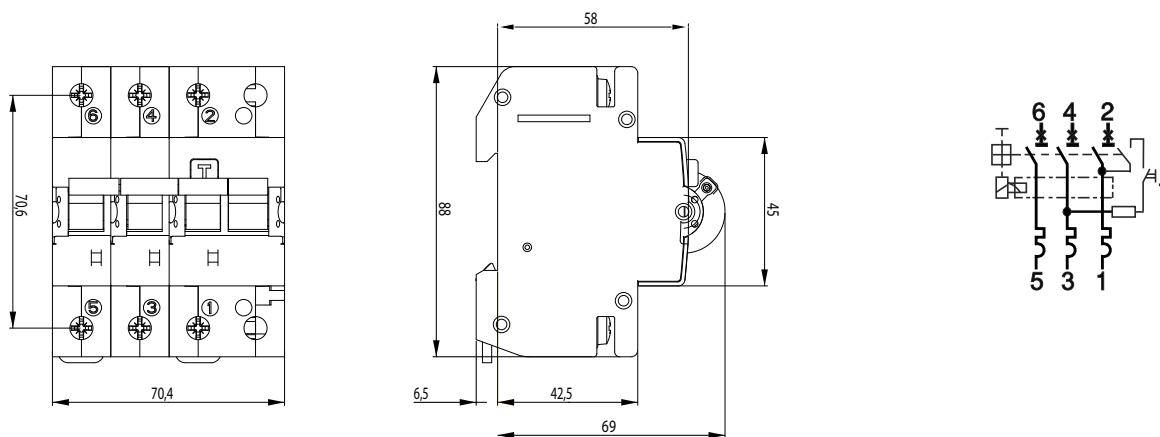

Conductor cross-section [mm ²]	Number of single conductors, rigid, single-wire CU conductor				
	1	2	3	4	5
1,5	✓	✓	✓	✓	✗
2,5	✓	✓	✓	✗	✗
4	✓	✓	✓	✗	✗
6	✓	✓	✗	✗	✗
10	✓	✗	✗	✗	✗
16	✓	✗	✗	✗	✗
25	✓	✗	✗	✗	✗

Conductor cross-section [mm ²]	Number of single conductors, flexible Cu conductors with cable ferrule					
	1	2	3	4	5	6
1,5	✓	✓	✓	✓	✓	✓
2,5	✓	✓	✓	✓	✓	✓
4	✓	✓	✓	✓	✓	✓
6	✓	✓	✓	✗	✗	✗
10	✓	✓	✗	✗	✗	✗
16	✓	✗	✗	✗	✗	✗
25	✓	✗	✗	✗	✗	✗

Remark: When you use more than 2 cables you have to be careful how those cables are inserted to ensure proper pressure on each cable

Combination of rigid single-wire and flexible multi-wire Cu conductors is not allowed

Residual current circuit breaker with integral overcurrent protection KZS-4M 3p+N

Rated short-circuit capacity
6 kA

Rated current
6 - 32 A

Tripping characteristic
B, C

Rated residual current
0,03 A - 0,5 A

Technical data

Rated voltage U_n	400/415V AC
Rated current I_n	6-32 A
Rated frequency f_n	50/60 Hz
Rated impulse withstand voltage U_{imp}	4 kV
Rated short-circuit capacity	6.000 A
Back-up fuse	100 A gG
Tripping characteristic	B, C
Energy limiting class	3
Type	AC, A
Rated residual current $I_{\Delta n}$	30, 100, 300, 500 mA
Rated residual making and breaking capacity $I_{\Delta n}$	4500A
Terminals	1-25 mm ² , max. 3 Nm
Terminal screw	M5 (Pozidrive PZ2)
Rated insulation Voltage U_i	500 V
Peak withstand current	250 A
Resistance according to vibrations acc. to IEC 60068-2-7	5g (10, 60 & 500Hz)
Degree of protection	IP20
Busbar thickness	0,8 - 2 mm
Operating temperature	-25°C ... +60°C
Storage temperature	-40°C ... +70°C
Width	70 mm
Mounting position	any
Standard	EN 61009-1

KZS-4M 3p+N $I_{\Delta n} = 30$ mA



I_n [A]	Type A Characteristic B	Code No. B	Type A Characteristic C	Code No. C	g	Box
6	KZS-4M 3p+N A B6/0.03	002174901	KZS-4M 3p+N A C6/0.03	002174921	515	1/27
10	KZS-4M 3p+N A B10/0.03	002174902	KZS-4M 3p+N A C10/0.03	002174922	515	1/27
13	KZS-4M 3p+N A B13/0.03	002174903	KZS-4M 3p+N A C13/0.03	002174923	515	1/27
16	KZS-4M 3p+N A B16/0.03	002174904	KZS-4M 3p+N A C16/0.03	002174924	515	1/27
20	KZS-4M 3p+N A B20/0.03	002174905	KZS-4M 3p+N A C20/0.03	002174925	515	1/27
25	KZS-4M 3p+N A B25/0.03	002174906	KZS-4M 3p+N A C25/0.03	002174926	515	1/27
32	KZS-4M 3p+N A B32/0.03	002174907	KZS-4M 3p+N A C32/0.03	002174927	515	1/27

KZS-4M 3p+N $I_{\Delta n} = 30$ mA

I_n [A]	Type A Characteristic B	Code No. B	Type A Characteristic C	Code No. C	g	Box
6	KZS-4M 3p+N AC B6/0.03	002174001	KZS-4M 3p+N AC C6/0.03	002174021	515	1/27
10	KZS-4M 3p+N AC B10/0.03	002174002	KZS-4M 3p+N AC C10/0.03	002174022	515	1/27
13	KZS-4M 3p+N AC B13/0.03	002174003	KZS-4M 3p+N AC C13/0.03	002174023	515	1/27
16	KZS-4M 3p+N AC B16/0.03	002174004	KZS-4M 3p+N AC C16/0.03	002174024	515	1/27
20	KZS-4M 3p+N AC B20/0.03	002174005	KZS-4M 3p+N AC C20/0.03	002174025	515	1/27
25	KZS-4M 3p+N AC B25/0.03	002174006	KZS-4M 3p+N AC C25/0.03	002174026	515	1/27
32	KZS-4M 3p+N AC B32/0.03	002174007	KZS-4M 3p+N AC C32/0.03	002174027	515	1/27



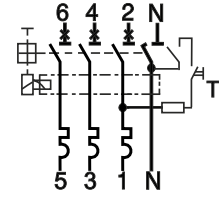

KZS-4M 3p+N I_{Δn} = 100 mA

I _n [A]	Type A Characteristic B	Code No. B	Type A Characteristic C	Code No. C		
6	KZS-4M 3p+N A B6/0.1	002174401	KZS-4M 3p+N A C6/0.1	002174421	515	1/27
10	KZS-4M 3p+N A B10/0.1	002174402	KZS-4M 3p+N A C10/0.1	002174422	515	1/27
13	KZS-4M 3p+N A B13/0.1	002174403	KZS-4M 3p+N A C13/0.1	002174423	515	1/27
16	KZS-4M 3p+N A B16/0.1	002174404	KZS-4M 3p+N A C16/0.1	002174424	515	1/27
20	KZS-4M 3p+N A B20/0.1	002174405	KZS-4M 3p+N A C20/0.1	002174425	515	1/27
25	KZS-4M 3p+N A B25/0.1	002174406	KZS-4M 3p+N A C25/0.1	002174426	515	1/27
32	KZS-4M 3p+N A B32/0.1	002174407	KZS-4M 3p+N A C32/0.1	002174427	515	1/27



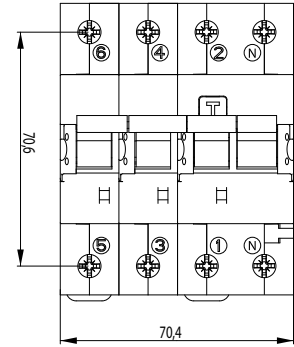

KZS-4M 3p+N I_{Δn} = 300 mA

I _n [A]	Type A Characteristic B	Code No. B	Type A Characteristic C	Code No. C		
6	KZS-4M 3p+N A B6/0.3	002174501	KZS-4M 3p+N A C6/0.3	002174521	515	1/27
10	KZS-4M 3p+N A B10/0.3	002174502	KZS-4M 3p+N A C10/0.3	002174522	515	1/27
13	KZS-4M 3p+N A B13/0.3	002174503	KZS-4M 3p+N A C13/0.3	002174523	515	1/27
16	KZS-4M 3p+N A B16/0.3	002174504	KZS-4M 3p+N A C16/0.3	002174524	515	1/27
20	KZS-4M 3p+N A B20/0.3	002174505	KZS-4M 3p+N A C20/0.3	002174525	515	1/27
25	KZS-4M 3p+N A B25/0.3	002174506	KZS-4M 3p+N A C25/0.3	002174526	515	1/27
32	KZS-4M 3p+N A B32/0.3	002174507	KZS-4M 3p+N A C32/0.3	002174527	515	1/27



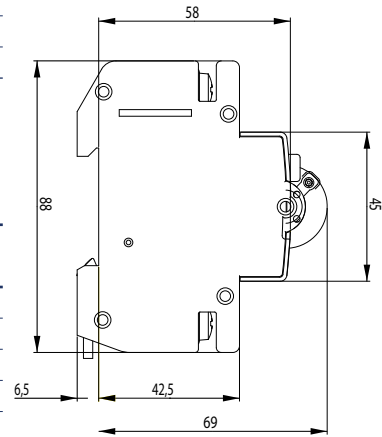

KZS-4M 3p+N I_{Δn} = 500 mA

I _n [A]	Type A Characteristic B	Code No. B	Type A Characteristic C	Code No. C		
6	KZS-4M 3p+N A B6/0.5	002174601	KZS-4M 3p+N A C6/0.5	002174621	515	1/27
10	KZS-4M 3p+N A B10/0.5	002174602	KZS-4M 3p+N A C10/0.5	002174622	515	1/27
13	KZS-4M 3p+N A B13/0.5	002174603	KZS-4M 3p+N A C13/0.5	002174623	515	1/27
16	KZS-4M 3p+N A B16/0.5	002174604	KZS-4M 3p+N A C16/0.5	002174624	515	1/27
20	KZS-4M 3p+N A B20/0.5	002174605	KZS-4M 3p+N A C20/0.5	002174625	515	1/27
25	KZS-4M 3p+N A B25/0.5	002174606	KZS-4M 3p+N A C25/0.5	002174626	515	1/27
32	KZS-4M 3p+N A B32/0.5	002174607	KZS-4M 3p+N A C32/0.5	002174627	515	1/27



KZS-4M 3p+N 120V I_{Δn} = 30 mA

I _n [A]	Type A Characteristic B	Code No. B	Type A Characteristic C	Code No. C		
6	KZS-4M 3p+N A B6/0.03 120V	002174451	KZS-4M 3p+N A C6/0.03 120V	002174491	515	1/27
10	KZS-4M 3p+N A B10/0.03 120V	002174452	KZS-4M 3p+N A C10/0.03 120V	002174492	515	1/27
13	KZS-4M 3p+N A B13/0.03 120V	002174453	KZS-4M 3p+N A C13/0.03 120V	002174493	515	1/27
16	KZS-4M 3p+N A B16/0.03 120V	002174454	KZS-4M 3p+N A C16/0.03 120V	002174494	515	1/27
20	KZS-4M 3p+N A B20/0.03 120V	002174455	KZS-4M 3p+N A C20/0.03 120V	002174495	515	1/27
25	KZS-4M 3p+N A B25/0.03 120V	002174456	KZS-4M 3p+N A C25/0.03 120V	002174496	515	1/27
32	KZS-4M 3p+N A B32/0.03 120V	002174457	KZS-4M 3p+N A C32/0.03 120V	002174497	515	1/27

Accessories for KZS



PS KZS-2M/4M is an auxiliary switch used for remote signalling of the RCBO to which it is fixed on the right side. PS KZS-2M/4M may also be fitted later on. Clamps are safe to touch. External dimensions comply with RCBO, built-in width is 0,5 module (9 mm). During fitting, the RCBO must be switched off. The auxiliary switch can be used in combination with RCBOs manufactured after 1. 10. 2018. The production date is visible on the bottom of the product or above the test button. The number must be greater than 18401.

Technical data

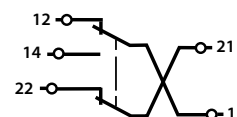
Function	Auxiliary Switch
Rated voltage	230V AC/DC, 110V DC
Rated current	6A (230V AC); 1A (110V DC); 0,5A (220V DC)
Rated frequency	50/60Hz, DC
Index of protection	IP 20 (IP 40)
Terminal capacity	1,5mm ²
Terminal Screw	M3 PH1
Terminal torque	max 0,5Nm
Ambient temperature	-25°C ... +40°C
Storage temperature	-40°C ... +70°C
Contacts	1x NC, 1x NC/NO
Mounting position	any
Standards	EN 62019



Auxiliary switch PS KZS-2M/4M

Type	Code No.	contacts		
PS KZS-2M/4M	002159500	1xNC, 1xNC/NO	53	1/12

AUX switch connections	status of the breaker	
	ON	OFF
11-14 NO	1	0
11-12 NC	0	1
21-22 NC	0	1

NO - Normally open contact --> during the activation it makes a contact
 NC - Normally closed contact --> during the activation it brakes the contact
 1 - contact
 0 - without a contact

Suitable for use with:

Type	Suitable
KZS-1M	✗
KZS 1M-FN	✗
KZS-2M	✓
KZS-2M2p	✗
KZS-4M 3p	✓
KZS-4M 3p+N	✓
KZS-4M2p	✗
AFDD	✗

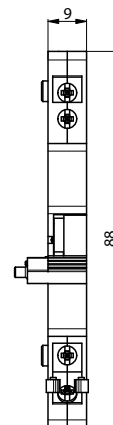

Residual current circuit breaker with integral overcurrent protection KZS-4M 2p B

 Rated short-circuit capacity
10 kA



 Rated current
6 - 40 A

 Tripping characteristic
B, C

 Rated residual current
0,03 A - 0,3 A
Technical data

Electrical	
Rated voltage U_n	230 V AC
Rated current I_n	6, 10, 13, 16, 20, 25, 32, 40 A
Rated Insulation voltage U_i	440 V
Peak withstand current	3kA (8/20 μ s) surge current proof
Electrical isolation	> 4mm contact space
Rated residual operating current $I_{\Delta n}$	30, 100, 300mA
Rated short-circuit capacity	10kA
Maximum back-up fuse	100A gG
Insulating class	B
Standard	IEC/EN 61009-1, IEC/EN 62423
Mechanical endurance	20.000
Electrical endurance	10.000
Mechanical	EN 61009-1
Frame size	45mm
Device height	69 mm
Device width	70 mm
Degree of protection	IP20
Upper and lower terminals	open mounted/lift terminals
Terminal capacity	1-25 mm ²
Terminal screw	M5 (Pozidrive PZ2)
Terminal torque	max 3,0 Nm
Operating temperature	-25°C ... +60°C
Storage and transport temperature	-40°C ... +70°C
Resistance to climatic conditions	IEC/EN 61009
Contact position indicator	mechanical red/green
Supply possibility	Top or bottom

KZS-4M 2p B $I_{\Delta n} = 30$ mA

I_n [A]	Characteristic B	Code No. B	Characteristic C	Code No. C		
6	KZS-4M 2p B B6/0.03	002174511	KZS-4M 2p B C6/0.03	002174531	369	1/27
10	KZS-4M 2p B B10/0.03	002174512	KZS-4M 2p B C10/0.03	002174532	369	1/27
13	KZS-4M 2p B B13/0.03	002174513	KZS-4M 2p B C13/0.03	002174533	369	1/27
16	KZS-4M 2p B B16/0.03	002174514	KZS-4M 2p B C16/0.03	002174534	369	1/27
20	KZS-4M 2p B B20/0.03	002174515	KZS-4M 2p B C20/0.03	002174535	369	1/27
25	KZS-4M 2p B B25/0.03	002174516	KZS-4M 2p B C25/0.03	002174536	369	1/27
32	KZS-4M 2p B B32/0.03	002174517	KZS-4M 2p B C32/0.03	002174537	369	1/27
40	KZS-4M 2p B B40/0.03	002174518	KZS-4M 2p B C40/0.03	002174538	390	1/27



KZS-4M 2p B $I_{\Delta n} = 100 \text{ mA}$

I_n [A]	Characteristic B	Code No. B	Characteristic C	Code No. C	g	Box
6	KZS-4M 2p B B6/0.1	002174611	KZS-4M 2p B C6/0.1	002174631	369	1/27
10	KZS-4M 2p B B10/0.1	002174612	KZS-4M 2p B C10/0.1	002174632	369	1/27
13	KZS-4M 2p B B13/0.1	002174613	KZS-4M 2p B C13/0.1	002174633	369	1/27
16	KZS-4M 2p B B16/0.1	002174614	KZS-4M 2p B C16/0.1	002174634	369	1/27
20	KZS-4M 2p B B20/0.1	002174615	KZS-4M 2p B C20/0.1	002174635	369	1/27
25	KZS-4M 2p B B25/0.1	002174616	KZS-4M 2p B C25/0.1	002174636	369	1/27
32	KZS-4M 2p B B32/0.1	002174617	KZS-4M 2p B C32/0.1	002174637	369	1/27
40	KZS-4M 2p B B40/0.1	002174618	KZS-4M 2p B C40/0.1	002174638	390	1/27

**KZS-4M 2p B $I_{\Delta n} = 300 \text{ mA}$**

I_n [A]	Characteristic B	Code No. B	Characteristic C	Code No. C	g	Box
6	KZS-4M 2p B B6/0.3	002174811	KZS-4M 2p B C6/0.3	002174831	369	1/27
10	KZS-4M 2p B B10/0.3	002174812	KZS-4M 2p B C10/0.3	002174832	369	1/27
13	KZS-4M 2p B B13/0.3	002174813	KZS-4M 2p B C13/0.3	002174833	369	1/27
16	KZS-4M 2p B B16/0.3	002174814	KZS-4M 2p B C16/0.3	002174834	369	1/27
20	KZS-4M 2p B B20/0.3	002174815	KZS-4M 2p B C20/0.3	002174835	369	1/27
25	KZS-4M 2p B B25/0.3	002174816	KZS-4M 2p B C25/0.3	002174836	369	1/27
32	KZS-4M 2p B B32/0.3	002174817	KZS-4M 2p B C32/0.3	002174837	369	1/27
40	KZS-4M 2p B B40/0.3	002174818	KZS-4M 2p B C40/0.3	002174838	390	1/27

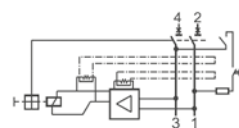
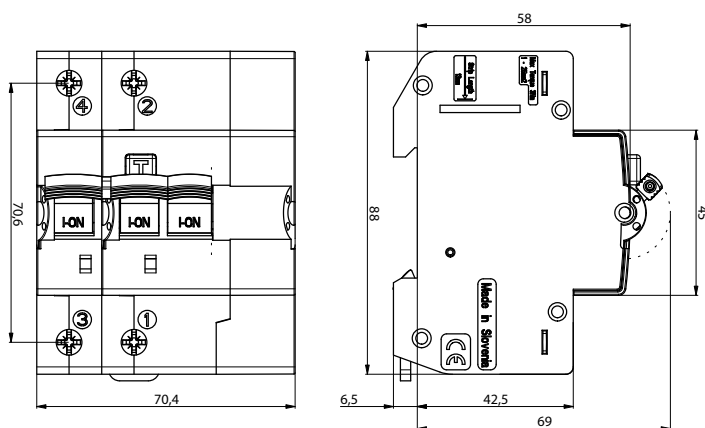

Arc Fault Detection Device AFDD

Rated short-circuit capacity
10 kA

Rated current
6 - 32 A

Tripping characteristic
B, C

Rated residual current
0,03 A

Complete protection: MCB, RCCB and AFDD in one device

Overcurrent and short circuit protection of both poles

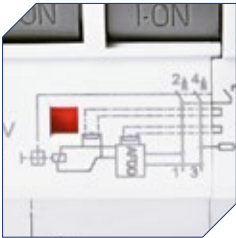

Supply is possible both from top and bottom terminals



LED indication of various types of fault



All necessary technical & installation information can be found on the front of the device



- High mechanical endurance: 20.000 cycles
- High electrical endurance: 10.000 cycles
- Rated short circuit capacity: 10 kA

Test button enables user to check residual functionality



Clearly marked terminals to ensure appropriate connection



Better protection of terminals against touching the parts under voltage



Real contact position indication for easier identification, whether the device is in ON or OFF position



Description - KZS AFDD is a device designed to prevent the occurrence of a fire by separating the electrical circuit in cases of arc locking (sparking) caused by a malfunction of the wiring.

Arc locking occurs in areas of the conductor fracture when the contact is lost or due to damage to the insulation between phases, neutral or earth conductors. Often arc circuits occur when the cables and their insulation are deformed by vibrations, thermal extensions and shrinkage, mechanical loads, aging, which leads to the formation of a dangerous spark in the electric circuit. The principle of operation AFDD is based on the tracking and analysis of high-frequency current components occurring in the controlled circuit.

Where should AFDD be used:

- ▀ premises in which ignition can lead to the deadly danger to people: kindergartens, elderly homes, educational institutions, hospitals, cinemas, hotels, airports, road and railway stations, bedrooms and children's rooms.
- ▀ flammable facilities: woodworking, furniture, paper, printing factories, wooden houses.
- ▀ premises, which are of historical or architectural value: libraries, museums, architectural monuments.

Arc locking is an unintentional sequential or parallel electric arc between conductors. It causes dangerous local overheating of conductors and ignition of their insulation, which then spreads to the building structure. This is one of the main causes of household fires due to malfunction of electrical wiring. Arc locking often cannot be detected and stopped using traditional fuses, circuit breakers and residual current devices or their combinations.

The arc locks are divided into three main types:



- ▀ **Consistent arc locking (sparking) in the line** - occurs if the wire or unreliable contact is located in series in the electrical circuit. This malfunction is not detected by circuit breakers, residual current protection relay or residual current circuit breakers because the current flowing in a circuit with a serial breakdown is less than the operating current. In this case, the occurrence of ignition is likely in the range of arc currents from 3 to 10A, with the duration of the arc that does not exceed 20 seconds. This type of breakdown is the least noticeable and therefore the most dangerous.
- ▀ **The parallel arc circuit between the phase (L) and neutral (N) or the phase (L1) and the phase conductor (L2/L3)** - occurs when the conductors are sparking in cases of damage. The value of the current is determined by the full resistance in the electrical circuit. If the full resistance in the electrical circuit is too high to reach the current disconnection current of the circuit breaker or a residual current circuit breaker, the electrical circuit will not be switched off. The KZS-AFDD device switches off the arc circuits in a line of 2,5A, which provides reliable protection in this case.
- ▀ **The parallel arc circuit between the phase (L) and the earth conductor (PE)** - the protection against arc circuits in relation to the protective earth conductor is securely provided by differential current devices such as residual current protection relays or residual current circuit breakers. KZS-AFDDs react to such breakage in the line and provide fire protection in cases where other residual current devices are not used.

Type of arc locking		The probability of a security device tripping			
		Circuit breaker (MCB, MCCB)	Residual current breaker (RCCB)	Residual current breaker with overcurrent protection (RCBO)	RCBO with arc fault detection function (AFDD)
Sequential arc locking (sparking) in line		✗	✗	✗	✓
Parallel arc locking between phase (L) and neutral (n) or phase (L1) and phase conductor (L2 / L3)		?	✗	?	✓
Parallel arc locking between phase (L) and earth conductor (PE)		?	✓	✓	✓

Technical data KZS - AFDD 3M 2p

Electrical	
Rated Voltage U_n	240 V AC
Rated current I_n	6, 10, 13, 15, 16, 20, 25, 32 A
Rated residual operating current $I_{\Delta n}$	30 mA
Rated frequency f_n	50Hz
Type	A
Tripping characteristic	B, C
Rated short-circuit capacity	10kA
Rated insulation voltage U_i	440 V
Rated impulse withstand voltage U_{imp}	4kV (1,2/50 μ s)
Peak withstand current	3kA (8/20 μ s) surge current proof
Voltage range test circuit	135-264V
Min operating voltage for AFDD function	180V
Rated residual making and breaking capacity $I_{\Delta m}$	4500A
Electrical isolation	> 4mm contact space
Max back-up fuse	100A gG
Insulating class	B
Standards	IEC/EN 61009-1, IEC/EN 62606
Mechanical Endurance (cycles)	20.000
Electrical endurance (cycles)	10.000
Mechanical	
Frame size	45mm
Device height	69 mm
Device width	53.5 mm
Degree of protection	IP20
Upper and lower terminals	open mounted/lift terminals
Terminal capacity	1-25 mm ²
Terminal screw	M5 (Pozidrive PZ2)
Terminal torque	max 3,0 Nm
Operating temperature	-25°C ... +50°C
Storage and transport temperature	-40°C ... +70°C
Resistance to climatic conditions	IEC/EN 61009-1
Shock resistance acc. to	IEC/EN 61009-1
Resistance to vibrations acc. to IEC60068-2-7	5g (10,60 & 500Hz)
Contact position indicator	mechanical red/green
Supply possibility	Top or bottom
Mounting on the rail	35mm acc to EN60715
Mounting position	any

KZS-AFDD 3M 2p

I_n [A]	$I_{\Delta n}$ [A]	Characteristic B	Code No. B	Characteristic C	Code No. C		
6	0.03	KZS-AFDD 3M2p A B6/0.03	002173811	KZS-AFDD 3M2p A C6/0.03	002173871	377	1/33
10		KZS-AFDD 3M2p A B10/0.03	002173812	KZS-AFDD 3M2p A C10/0.03	002173872	377	1/33
13		KZS-AFDD 3M2p A B13/0.03	002173813	KZS-AFDD 3M2p A C13/0.03	002173873	377	1/33
15		KZS-AFDD 3M2p A B15/0.03	002173819	KZS-AFDD 3M2p A C15/0.03	002173879	377	1/33
16		KZS-AFDD 3M2p A B16/0.03	002173814	KZS-AFDD 3M2p A C16/0.03	002173874	377	1/33
20		KZS-AFDD 3M2p A B20/0.03	002173815	KZS-AFDD 3M2p A C20/0.03	002173875	377	1/33
25		KZS-AFDD 3M2p A B25/0.03	002173816	KZS-AFDD 3M2p A C25/0.03	002173876	377	1/33
32		KZS-AFDD 3M2p A B32/0.03	002173817	KZS-AFDD 3M2p A C32/0.03	002173877	377	1/33



conductor cross-section [mm ²]	Number of single conductors, rigid, single-wire Cu conductor				
	1	2	3	4	5
1,5	✓	✓	✓	✓	✗
2,5	✓	✓	✓	✗	✗
4	✓	✓	✓	✗	✗
6	✓	✓	✗	✗	✗
10	✓	✓	✗	✗	✗
16	✓	✗	✗	✗	✗
25	✓	✗	✗	✗	✗

Remark: When you use more than 2 cables you have to be careful how those cables are inserted to ensure proper pressure on each cable

Conductor cross-section [mm ²]	Number of single conductors, flexible Cu conductors with cable ferrule					
	1	2	3	4	5	6
1,5	✓	✓	✓	✓	✓	✓
2,5	✓	✓	✓	✓	✓	✓
4	✓	✓	✓	✓	✓	✓
6	✓	✓	✓	✗	✗	✗
10	✓	✓	✗	✗	✗	✗
16	✓	✗	✗	✗	✗	✗
25	✓	✗	✗	✗	✗	✗

Combination of rigid single-wire and flexible multi-wire Cu conductors is not allowed

Time current characteristics I/t, KZS-AFDD

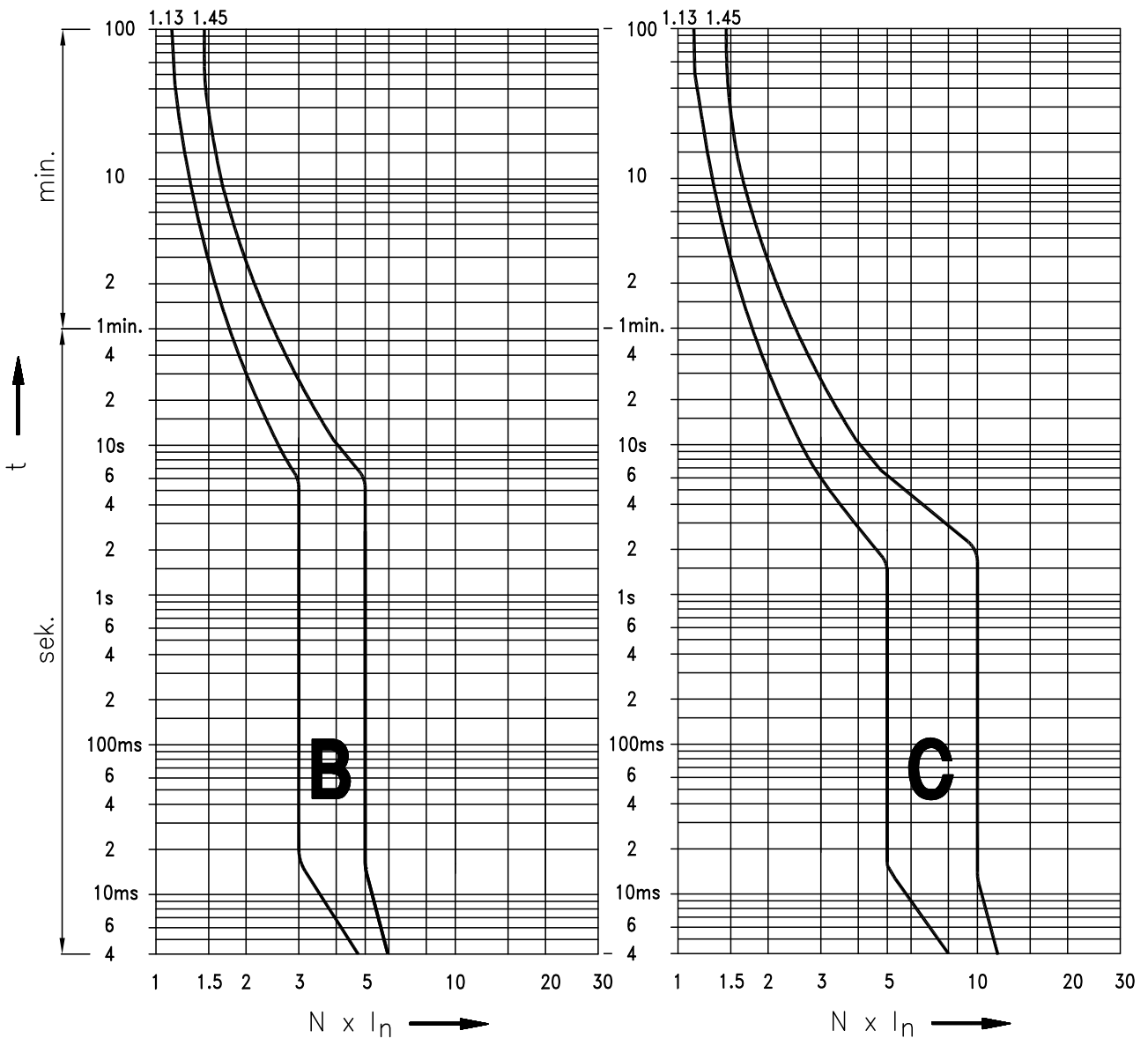

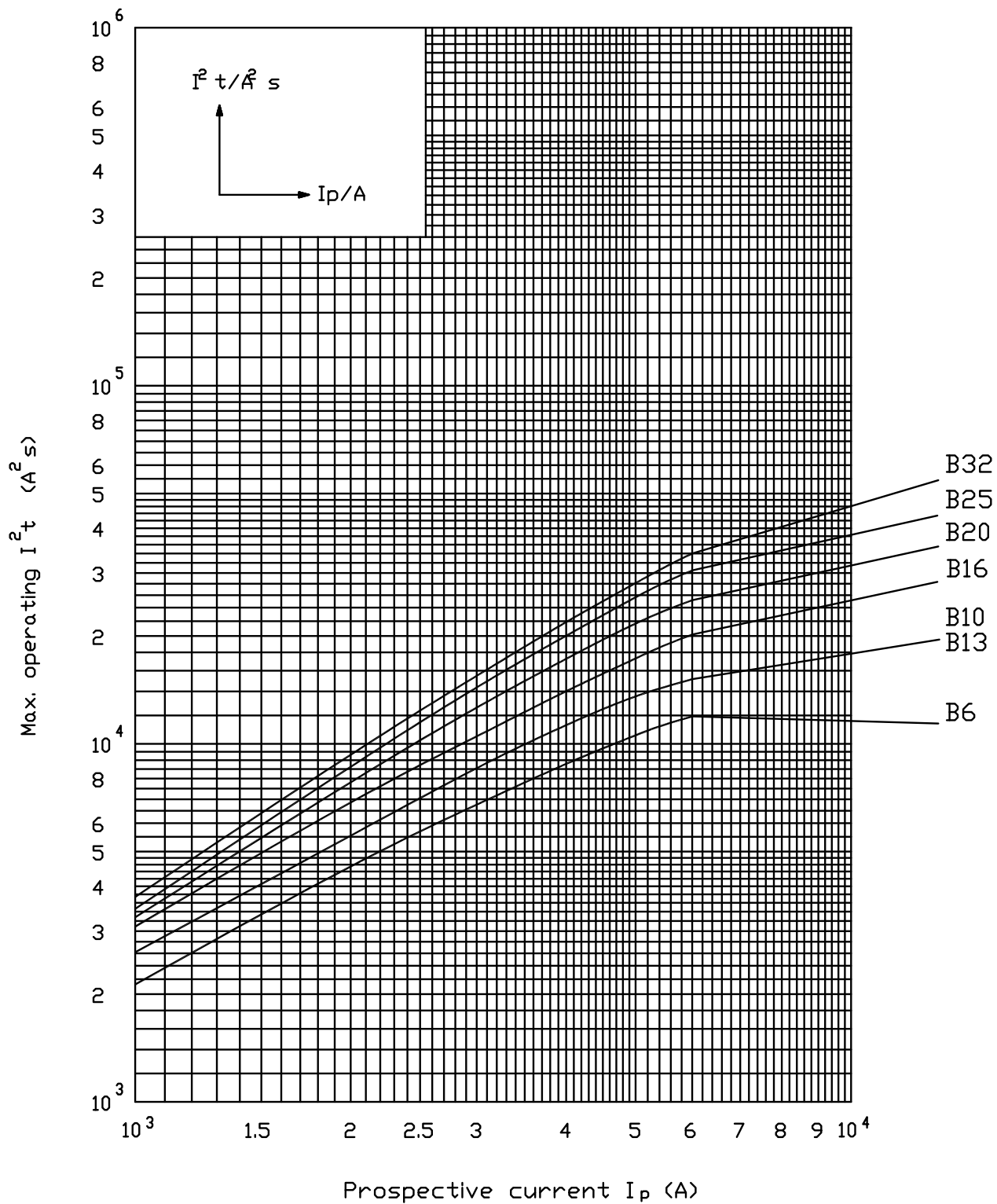
Melting energy characteristics I^2t KZS-AFDD

Melting energy characteristics I^2t KZS-AFDD

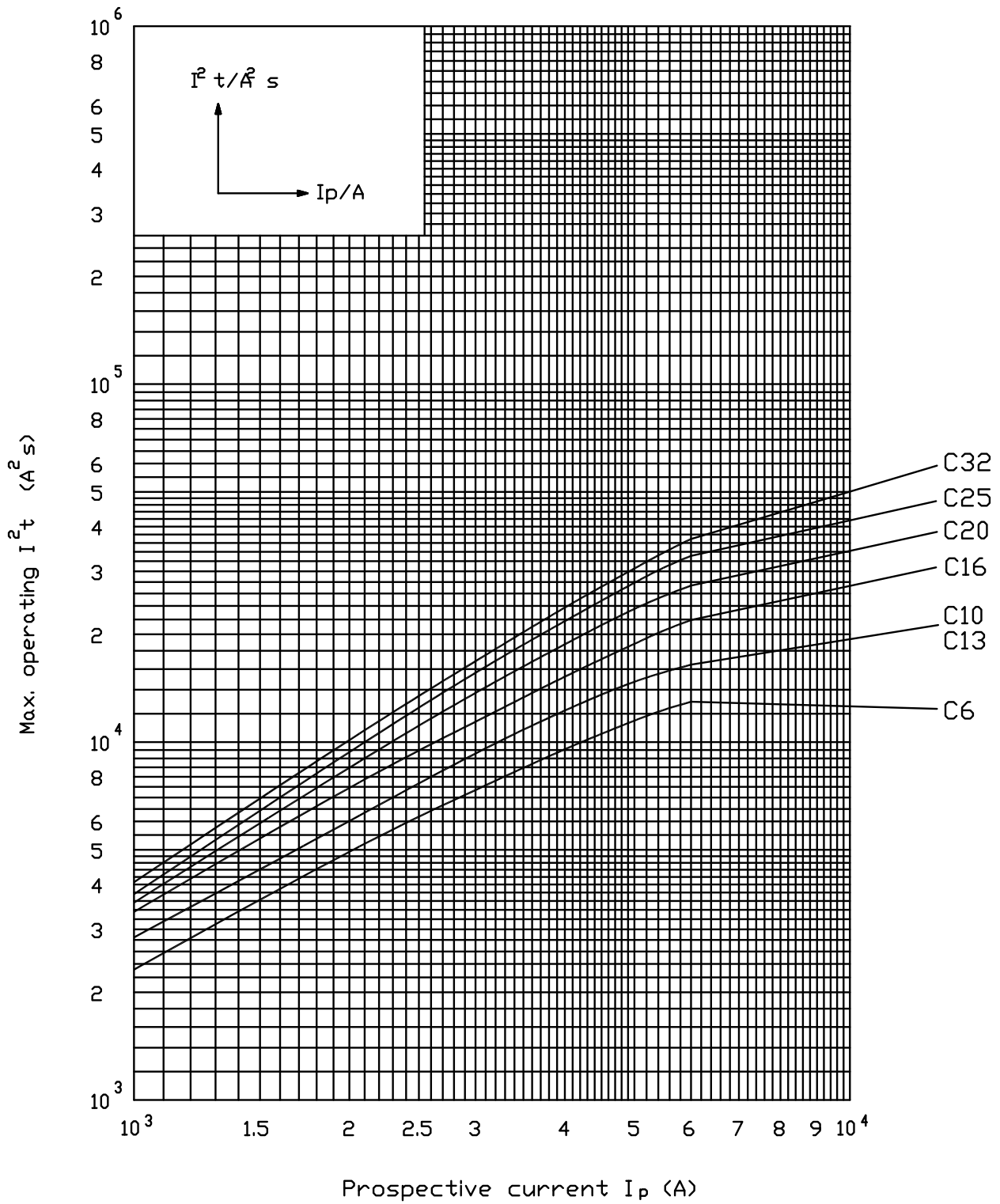

Cut-off current characteristics KZS-AFDD

